

USB2.0 Technical Manual

TDK Corporation Magnetics Business Group
Mitsuharu Mizutani

1 | Introduction

USB2.0 was released in April of 2000 and it has become the standard interface for connecting computers with peripheral devices.

This standard was established by a collaboration of Compaq, HP, Intel, Lucent, Microsoft, NEC, and Philips.

Until 2000, USB1.1 was available with data transfer speeds of 1.5 Mbps (Low speed) and 12 Mbps (Full speed). With USB 2.0 came the addition of 480 Mbps (High speed).

Comparison of Impedance Data Transmission Speeds for Each Interface (Mbps)

IEEE1394	USB1.1	USB2.0
100	1.5	1.5 (Low speed)
200	12	12 (Full speed)
400		480 (High speed)

* In 2009, USB3.0 was released which adds a 5 Gbps SuperSpeed transfer mode.

USB2.0 consists of four lines; two differential signal lines, the Vcc line and GND line. The repetitive pulse frequency at 480 Mbps is 240 MHz, so components for improving EMC such as chip beads affect the signal waveform, which means they are not appropriate. Common Mode Filters are best because they have less of an effect on the signal. TDK has conducted operation verification tests in collaboration with Intel and NEC, and have selected the optimal products for improving EMC.

2 | USB2.0 Waveform Response Standards

Strict standards are set for high-speed transmissions of 480 Mbps in order to prevent operation problems. The Eye-pattern and SYNC Field waveform response standards are especially important.

2-1. Eye-pattern

Eye-patterns is used to verify that the differential signal is transmitted with the proper waveform.

Standards differ according to the Test Points (TP₁ to TP₄) between devices. In reality, waveforms also differ according to the length of cables. Measured data using a short cable (0.5 m) and a long cable (5 m) will be used as examples.

The following figure shows the connections. Data sent from the HUB and the waveform were observed at the Device Test Point.

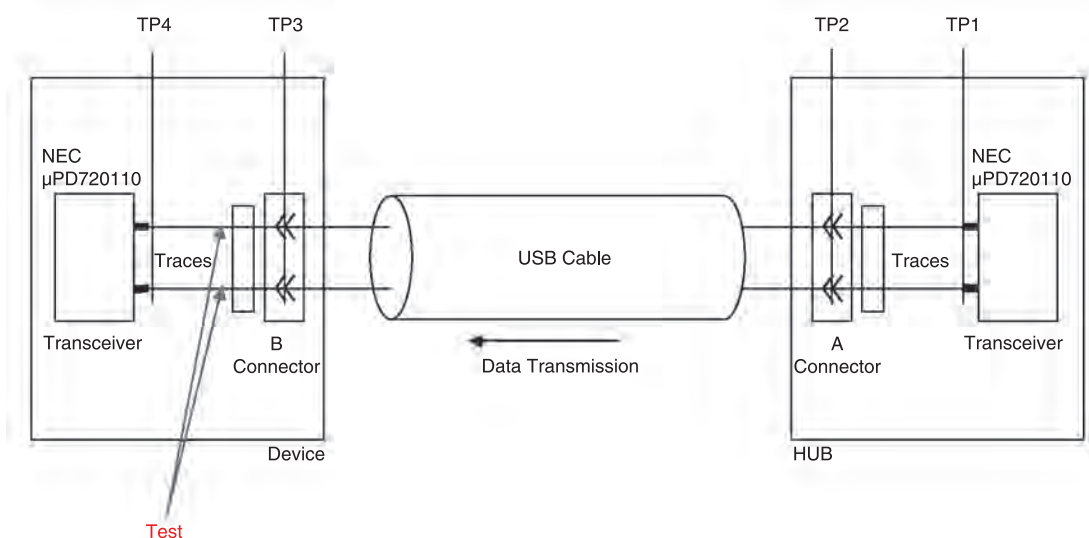

Observed Waveform

If the waveform does not enter the red area, it is considered to have met the standard.
The stricter TP2 standard was met for the 0.5 m cable.

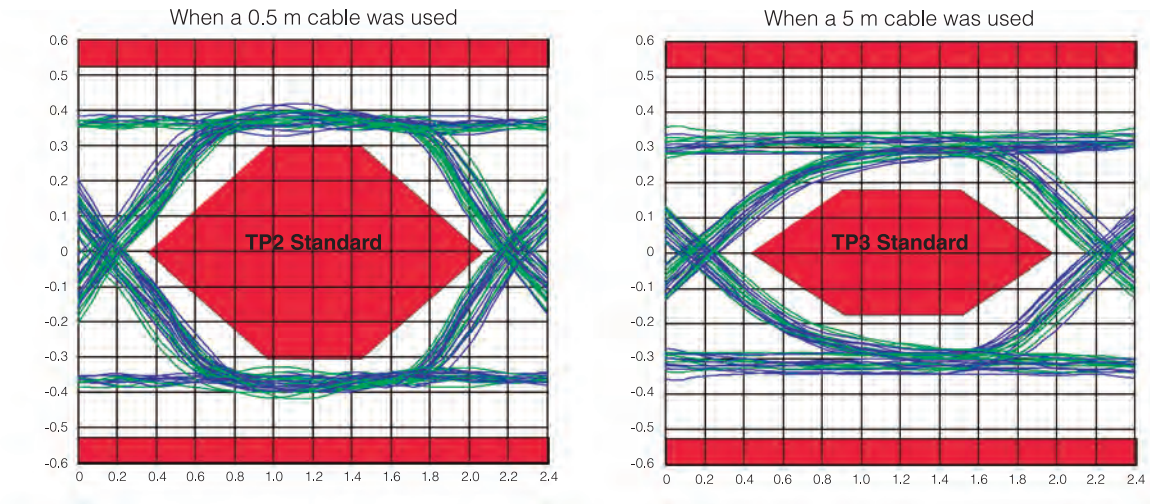

2-2. SYNC Field Waveform Response

For USB2.0, data is transferred with a 400 mVp-p differential signal.

After data is transferred, a 32-bit signal is transferred as an interval signal before the next data begins being transferred. This 32-bit interval signal is referred to as the SYNC Field.

When Common Mode Filters are used for improving EMC,

the beginning of the SYNC Field signal is given to the minus side because of coupling between the Common Mode Filter lines. This is the most important point to consider when selecting a Common Mode Filter. For safe operation, the desired voltage is 150 mV or higher starting from the first bit of the SYNC Field signal.

Explanation of SYNC Field

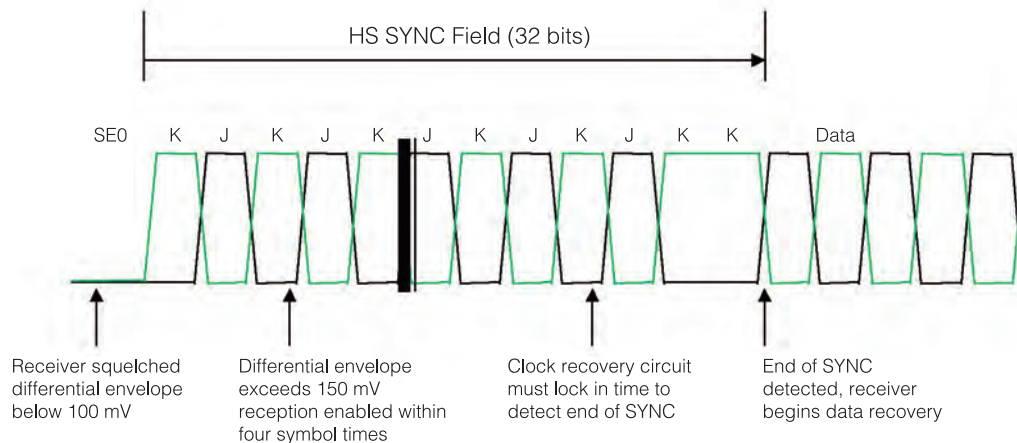

SYNC Field Waveform Response

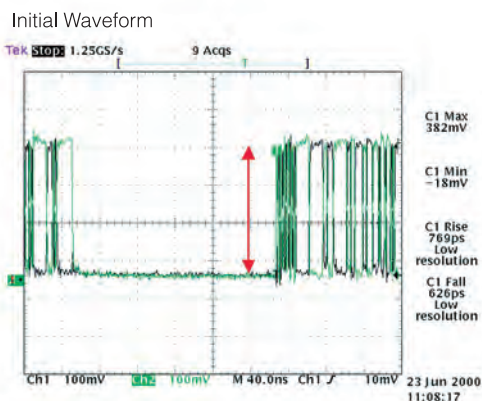

Waveform response when a Common Mode Filter was used

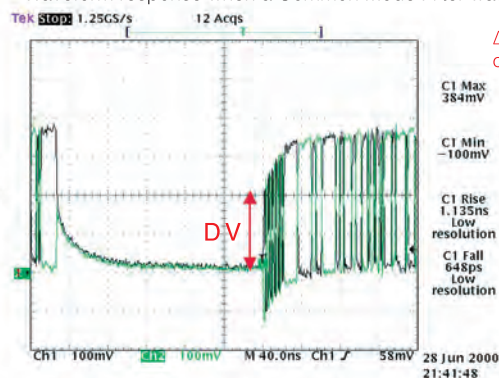

ΔV indicates 150 mV or higher

3 | Selecting Optimal Components for Improving EMC

For 480 Mbps high-speed transmission, it is important to select components that can effectively remove noise components without affecting the signal waveform.

It is also important to verify that no errors occur by conducting operation tests using USB2.0.

When checking waveforms and conducting operation tests,

it is necessary to consider actual usage conditions, so it is necessary to use the same components for improving EMC for both the HOST that sends the signal and the DEVICE that receives the signal.

All data here is based on when the same components for improving EMC are used for both ends.

3-1. Comparison of Eye-patterns Using Various Components for Improving EMC (0.5 m Cable)

1. Initial value

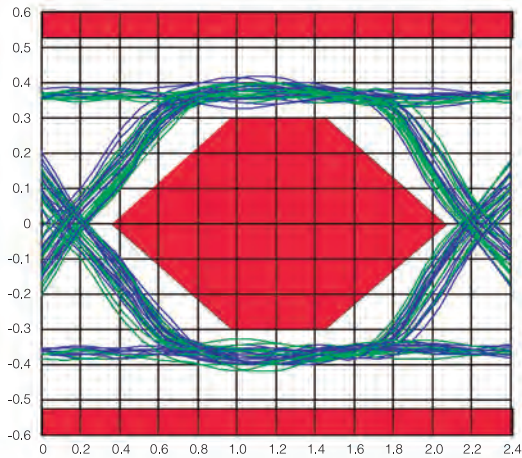

2. With MMZ1608Y121B (Chip Beads)
Impedance is 120 Ω at 100 MHz

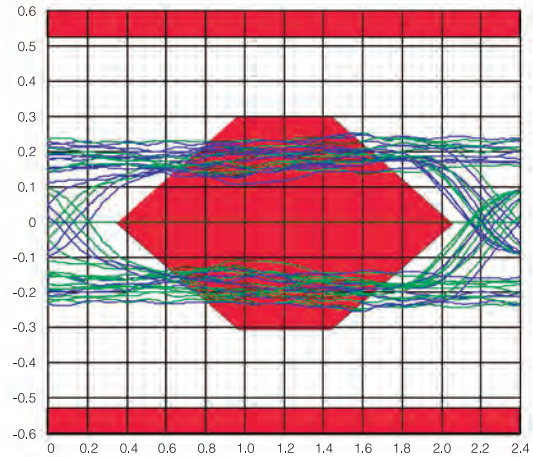

3. With ZJYS51R5-2P (Common Mode Filter)
Common Mode Impedance is 600 Ω at 100 MHz

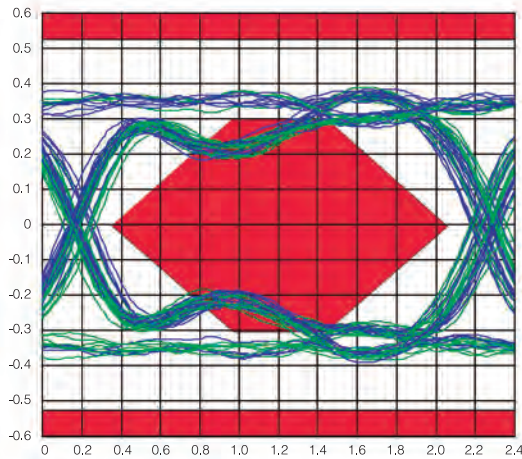

4. With ACM2012-900-2P (Common Mode Filter)
Common Mode Impedance is 90 Ω at 100 MHz

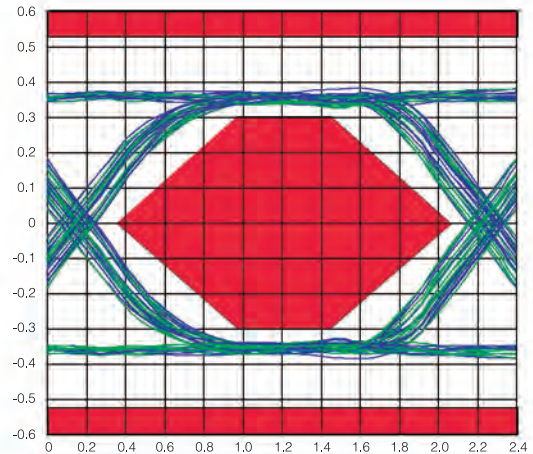

As shown by the above, Eye-pattern 2 shows that the differential signal at 240 MHz has attenuation due to the impedance of the chip beads. Eye-pattern 3 shows that the differential signal is strained because the characteristic impedance of the Common Mode Filter is very different from the

USB2.0 standard of 90 Ω . Both waveforms are in the red area, meaning they are NG.

Eye-pattern 4 shows the proper characteristic impedance, and it was evaluated as OK.

3-2. Comparison of SYNC Field Waveform Responses Using Various Components for Improving EMC (5 m Cable)

Connection for Evaluation

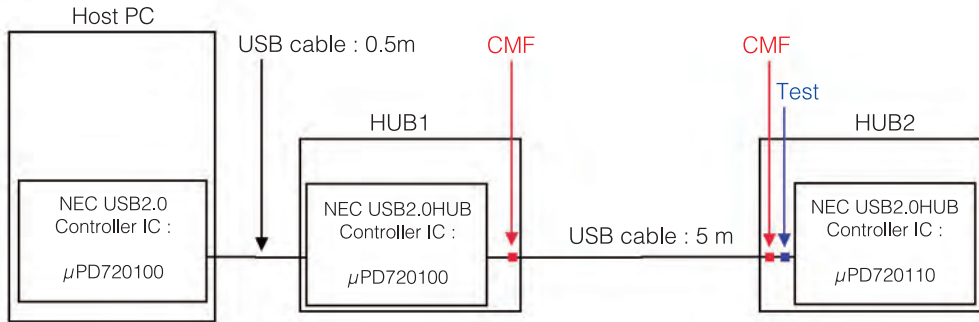

Evaluation Results

1. Initial value
2. With ACM2012-900-2P (Common Mode Filter)
Impedance is 90 Ω at 100 MHz

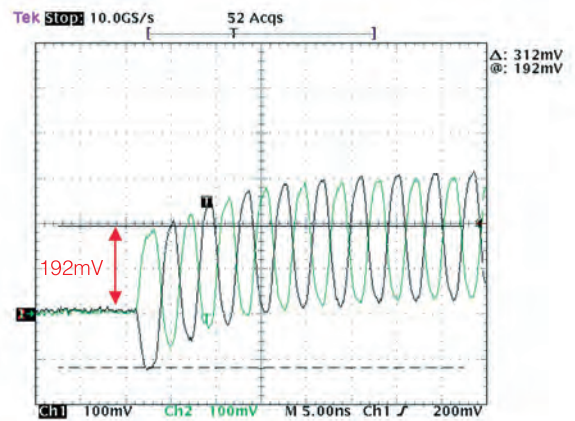
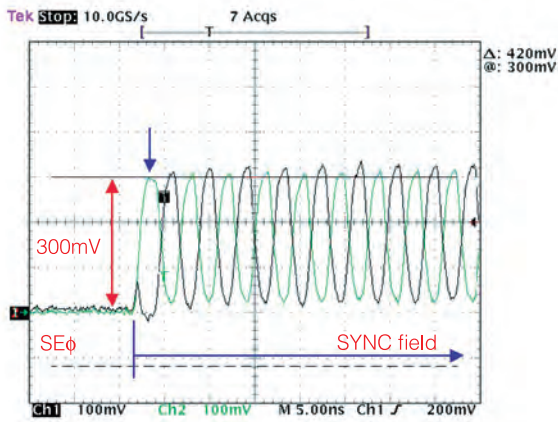

3. With ACM3225-102-2P (Common Mode Filter)
Common Mode Impedance is 1000 Ω at 100 MHz

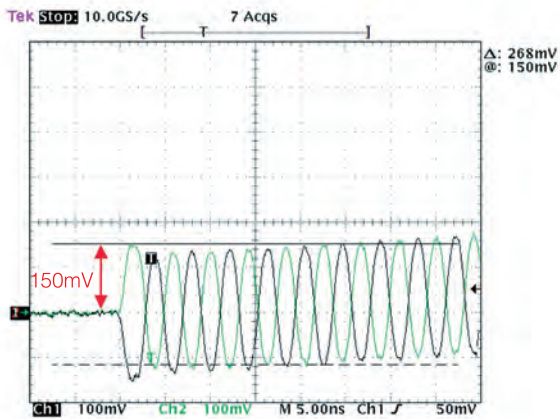

As shown in the above data, the waveform 3 shows that SYNC Field voltage was low and therefore was evaluated as NG. The waveform in 2 shows the SYNC Field voltage was high from

the beginning because the common mode impedance was kept low, so it was evaluated as OK.

4 | Recommended Components for Improving EMC

Because USB2.0 is capable of high-speed 480 Mbps bandwidth, components that cause unstable operation can not be used even if they are effective at removing noise.

Based on this, the recommended components were selected by evaluating Eye-patterns and SYNC Field waveform responses.

The following components are recommended.

2-Line Common Mode Filter:

For Computers and TVs ACM2012-900-2P, TCM1210F-900-2P

For Mobile Devices TCM1005F-900-2P, TCM0605-900-2P

When a 2-Line Common Mode Filter is used, it is also recommended to use chip beads for the Vcc line and GND line.

Chip Beads for DC Lines:

MPZ1608S101A, MPZ1608S221A

If the FCC or VCCI standards cannot be met after implementing final radiation noise prevention measures, a split type ferrite core can be used for USB cables, which are easy to implement and are very effective.

List of Recommended Components

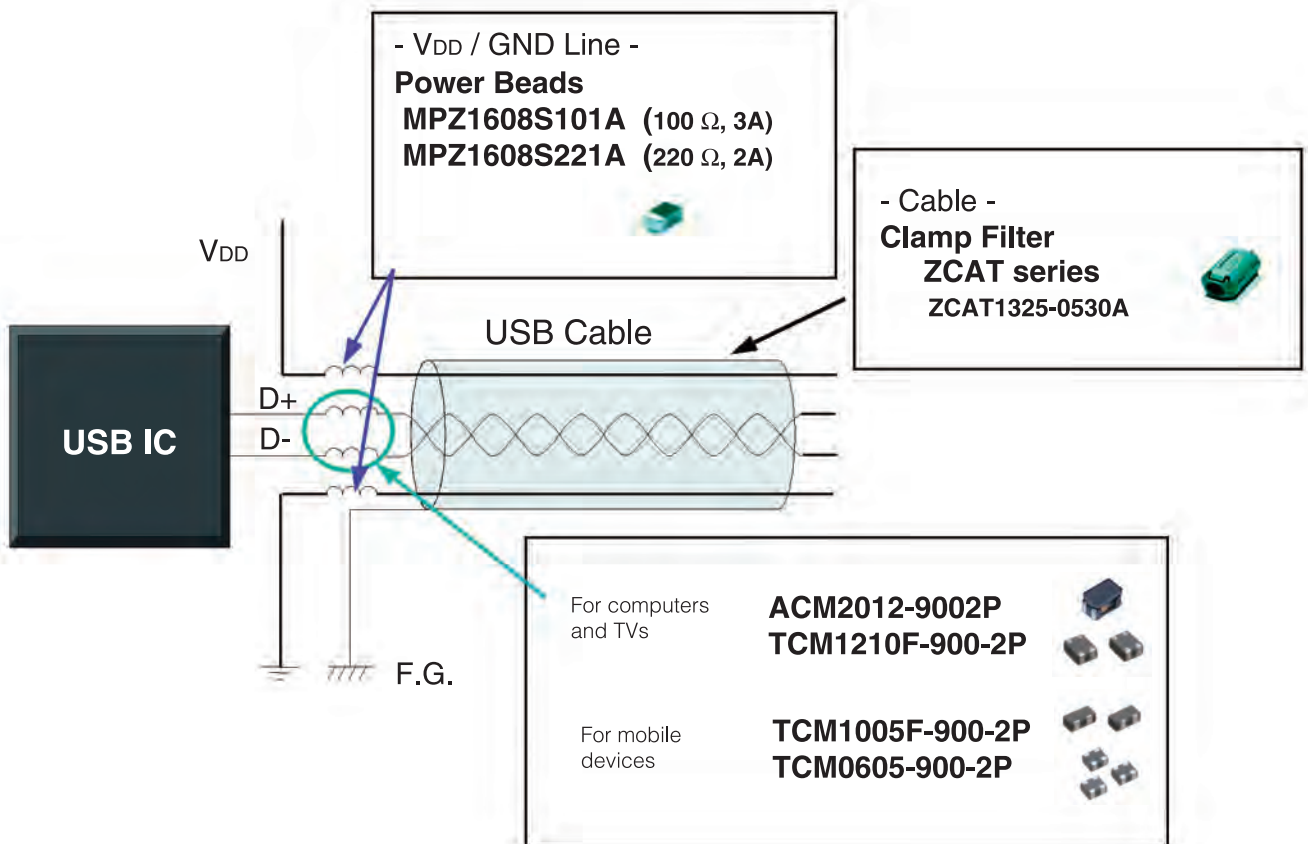

Eye-pattern Data for Recommended Common Mode Filters

Cable Length: 0.5 m

1. Initial value (No Common Mode Filter)

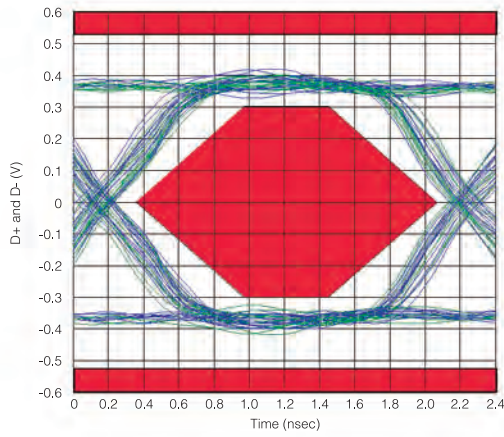

2. ACM2012-900-2P

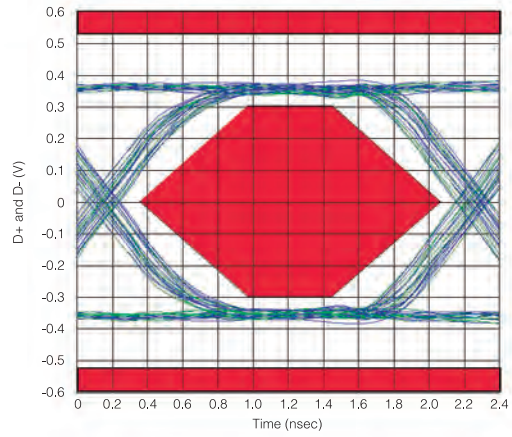

3. ACM3225-800-2P

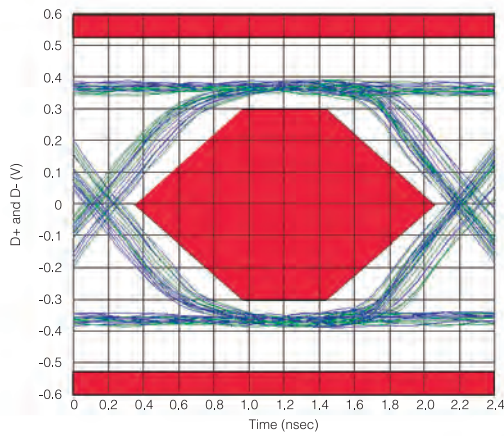

4. ACM3225-161-2P

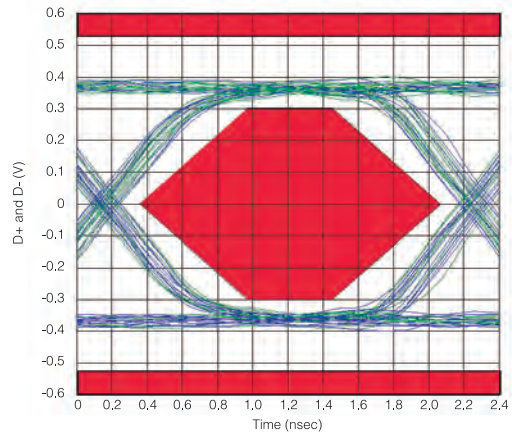

Eye-pattern Data for Recommended Common Mode Filters

Cable Length: 0.5 m

1. Initial value (No Common Mode Filter)

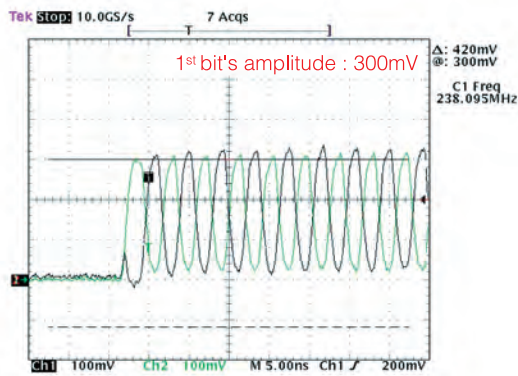

2. ACM2012-900-2P

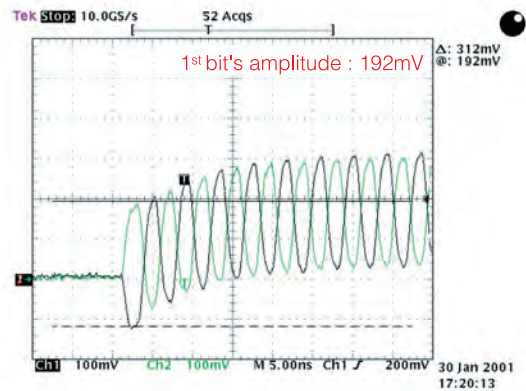

3. ACM3225-800-2P

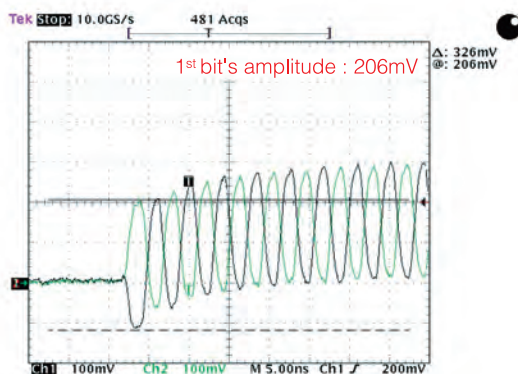

4. ACM3225-161-2P

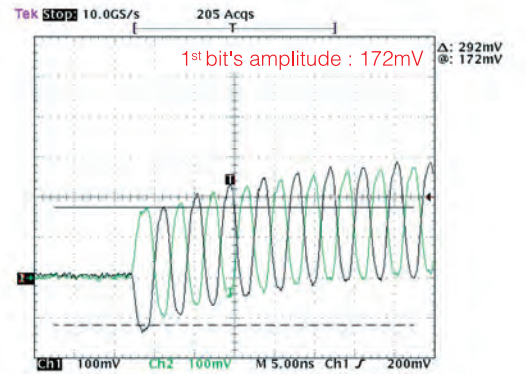

5 | Effectiveness Examples of Common Mode Filters for EMC Countermeasures

This section will explain the effectiveness of the recommended Common Mode Filters for EMC countermeasures.

5-1. Differential Signal Waveform Shaping Effectiveness

An ideal differential signal has no waveform strain and has no phase lag, and skew is a fixed voltage.

Skew is the total of the + signal ($D+$) and - signal ($D-$) ($D+ + D-$).

In reality, differential signals contain some strain, and skew is not a fixed voltage.

This is the cause of radiation noise.

By using a Common Mode Filter, it is possible to make the waveform as close as possible to ideal via waveform shaping. Skew voltage fluctuation is also reduced, which helps to reduce radiation noise.

Ideal Differential Signal

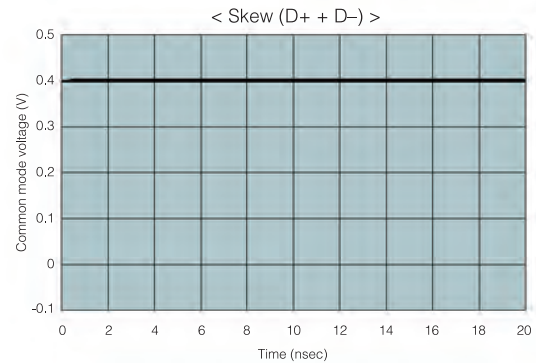
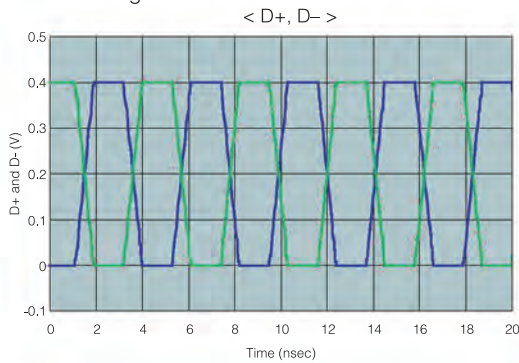

Actual Differential Signal

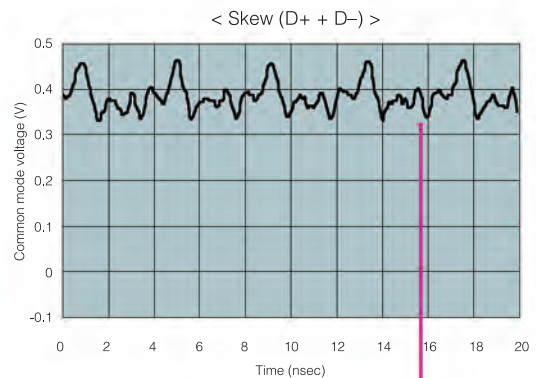
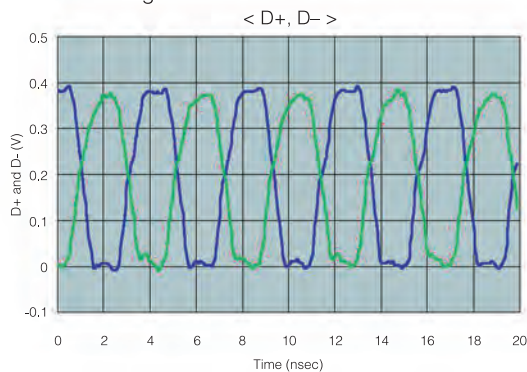

With ACM2012-900-2P (Common Mode Filter)

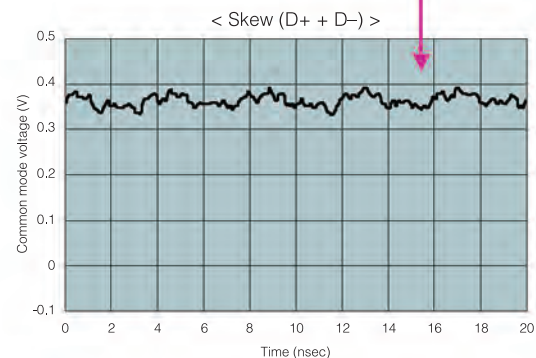
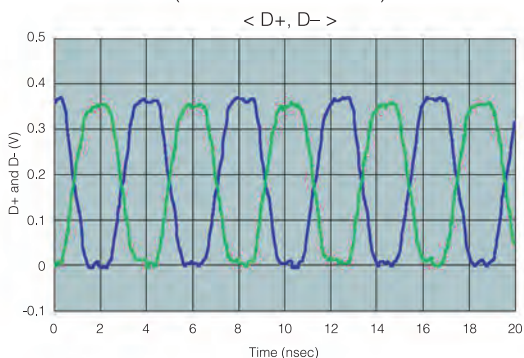

5-2. Effectiveness of Reducing Common Mode Noise Superimposed on the Differential Signal

When common mode noise is superimposed on the differential signal, skew also worsens and radiation noise is generated.

Common Mode Filters can effectively reduce common

Ideal differential signal when 1 GHz common mode noise was superimposed

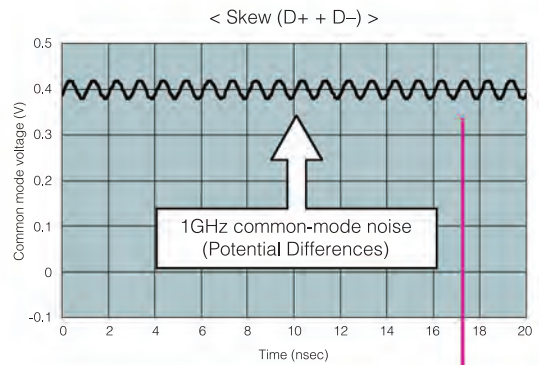
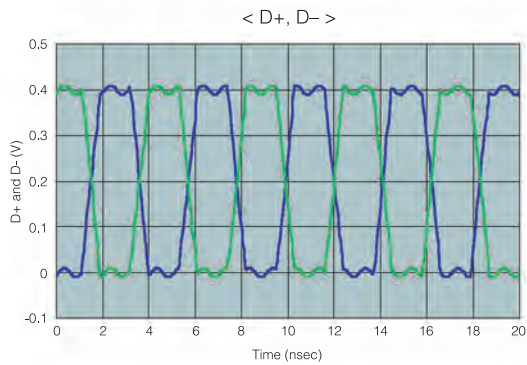

With ACM2012-900-2P (Common Mode Filter)

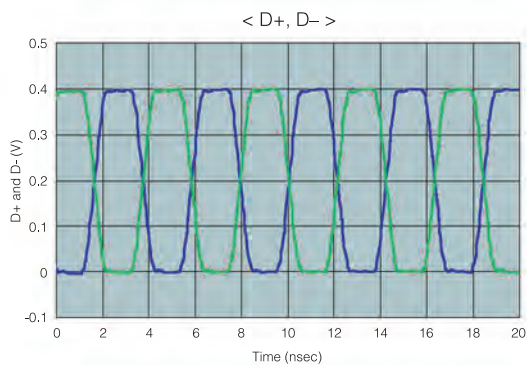

Common mode noise contained in the skew decreased

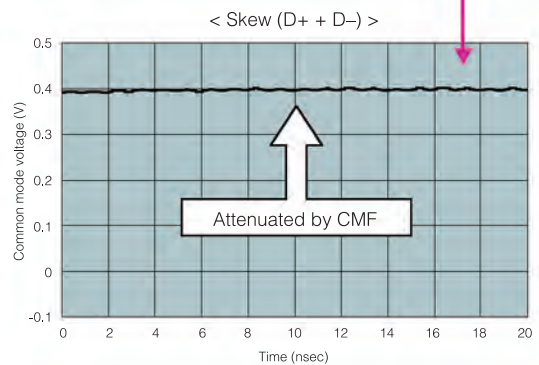

6 | Common Mode Filter Characteristic Impedance and its Influence on the Eye-pattern

The characteristic impedance is regulated to $90 \pm 20 \Omega$ for USB2.0 signal lines.

If a Common Mode Filter is used with a characteristic impedance that is far beyond the standard, the Eye-pattern will deteriorate.

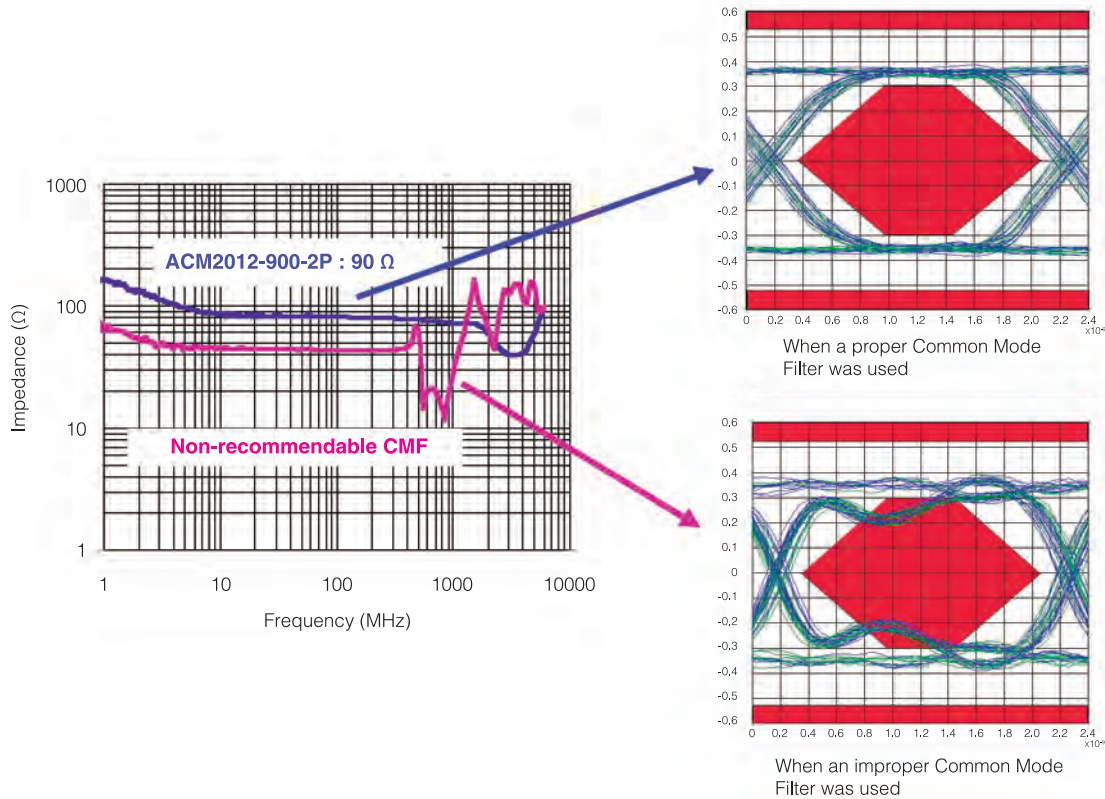

Comparison of characteristic impedance when ACM2012-900-2P with 90Ω was used and when a Common Mode Filter with 60Ω was used

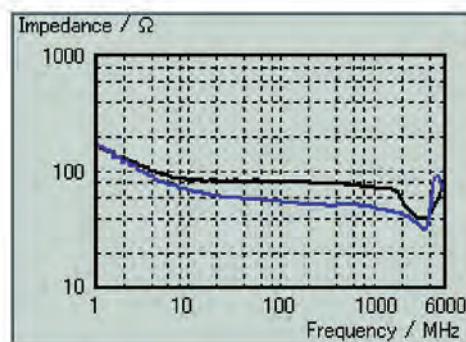

Characteristic Impedance Comparison Data
ACM2012-900-2P and Low Impedance Common Mode Filter

Eye-pattern deteriorated

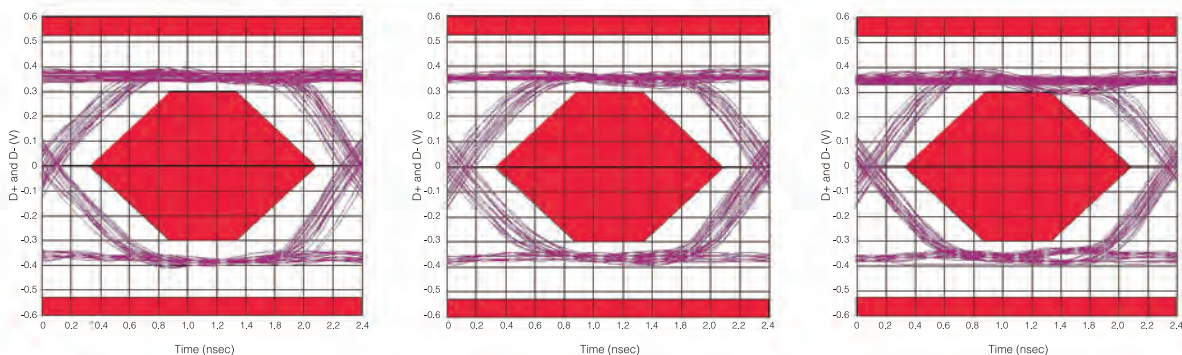

No Common Mode Filter

With ACM2012-900-2P

When a Common Mode Filter with a characteristic impedance of 60Ω was used

7 | Difference with TDR According to the Difference of Characteristic Impedance (TDR: Time Domain Reflectometry)

TDR is regulated as the characteristic impedance for USB 2.0 transmission system.

The following will explain the difference with TDR when an ACM2012-900-2P filter was used on an IC evaluation board, and when a Common Mode Filter with a low characteristic impedance was used.

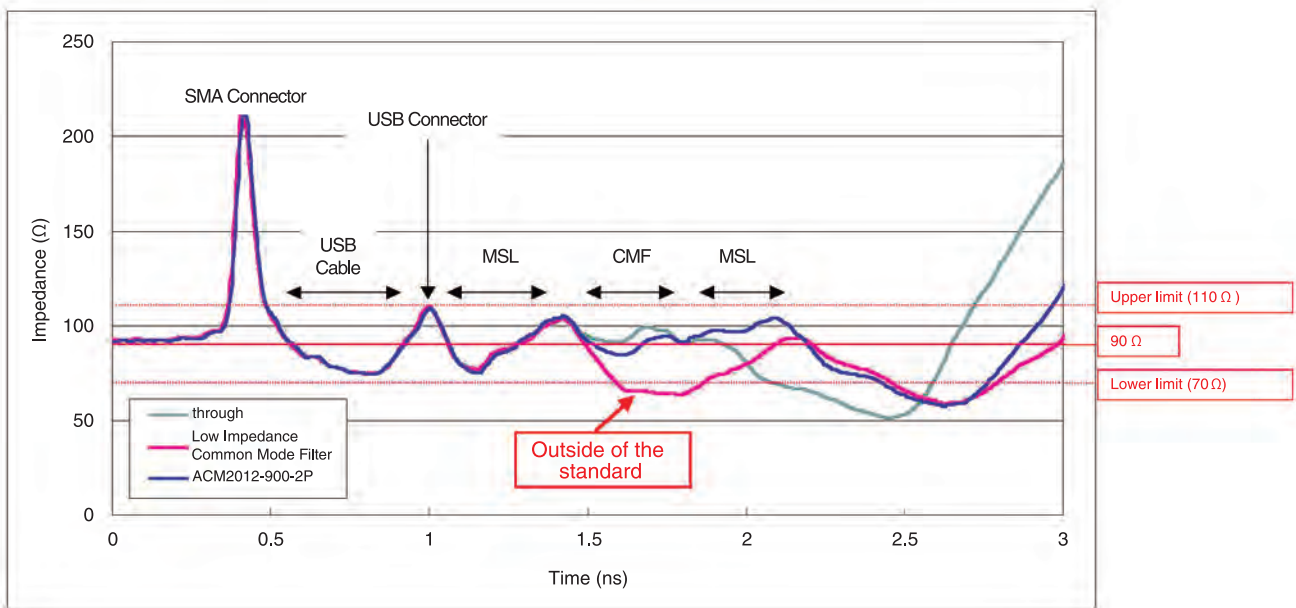
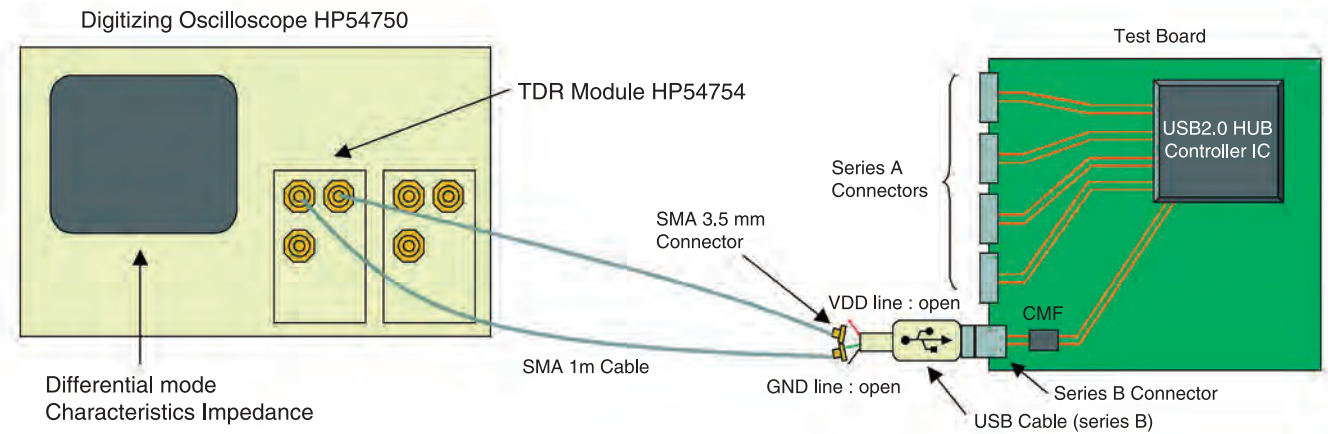

Measurement Results:

The TDR standard cannot be met when a Common Mode Filter with a low characteristic impedance is used.