

# C1005NP01H390J050BA

TDK Item Description : C1005NP01H390JT\*\*\*\*



## Application & Main Feature

Commercial Grade ( High Temperature Application )

## Series

C1005 [EIA CC0402]

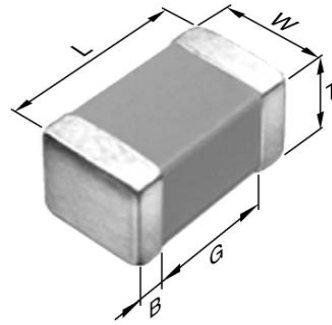

## Dimensions

L 1.00mm +/-0.05mm  
W 0.50mm +/-0.05mm  
T 0.50mm +/-0.05mm  
B 0.10mm Min.  
G 0.30mm Min.

## Temperature Characteristic

NP0 (-55 to 150 degC 0+/-30ppm/degC)

## Rated Voltage

1H (50Vdc)

## Capacitance

39pF

## Capacitance Tolerance

J (+/-5%)

## Q Factor

1000 Min.

## Insulation Resistance

10Gohm Min.

## AEC-Q200

Not Applicable

### |Z|, ESR vs. Freq. Characteristics

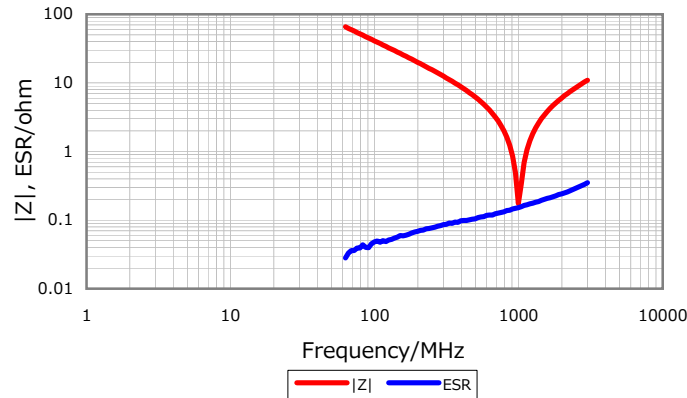

### DC Bias Characteristic



### Cap. vs. Freq. Characteristic

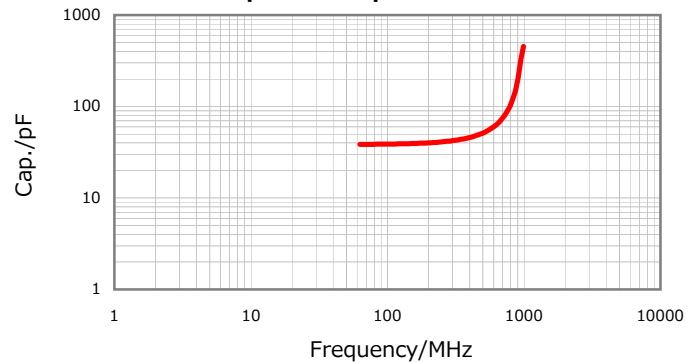

### Temperature Characteristics

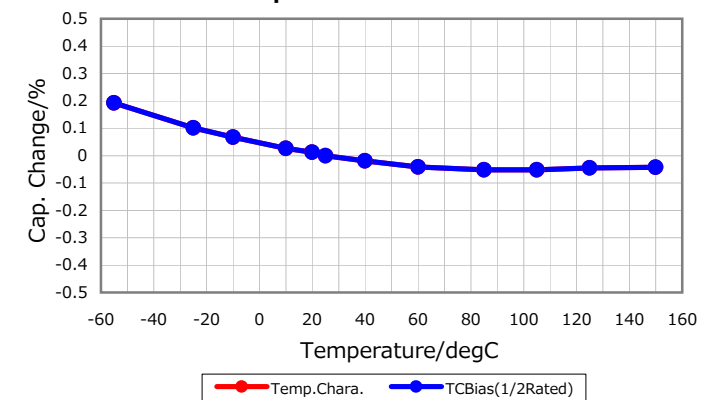

Characterization Sheet ( Multilayer Ceramic Chip Capacitors )



All specifications are subject to change without notice.

January 3, 2016