

C1608C0G1H822J080AA

TDK Item Description : C1608C0G1H822JT****



Application & Main Feature

Commercial Grade(Up to 50V)

Series

C1608 [EIA 0603]

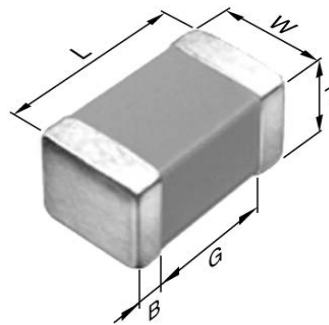

Dimensions

L	1.60mm ±0.10mm
W	0.80mm ±0.10mm
T	0.80mm ±0.10mm
B	0.20mm Min.
G	0.30mm Min.

Temperature Characteristic

C0G (-55 to 125 degC 0+/-30ppm/degC)

Rated Voltage

1H(50Vdc)

Capacitance

8.2nF

Capacitance Tolerance

J (±5%)

Q Factor

1000 Min.

Insulation Resistance

10Gohm Min

AEC-Q200

Not Applicable

DC Bias Characteristic

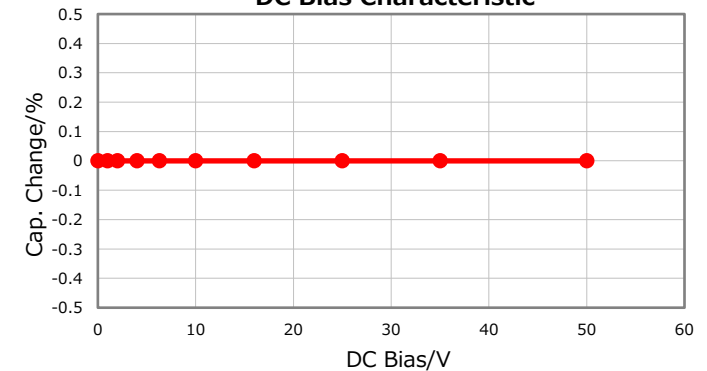

|Z|, ESR vs. Freq. Characteristics

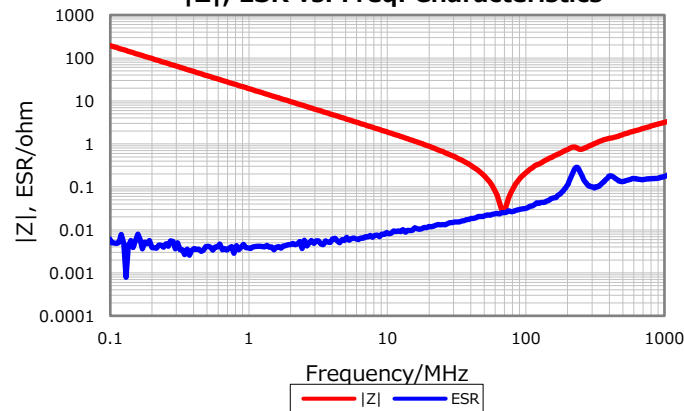

Temperature Characteristics

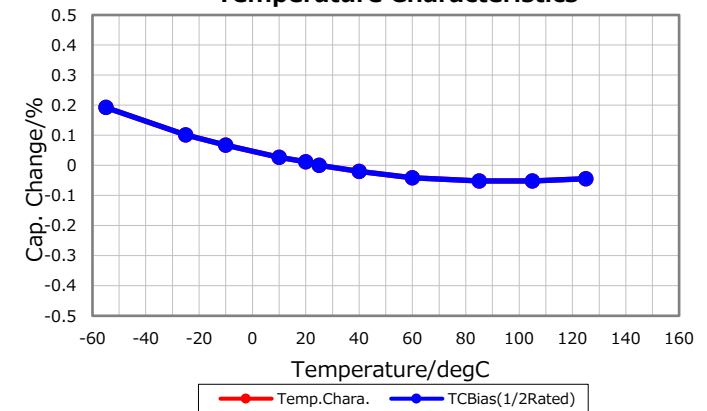

Cap. vs. Freq. Characteristic

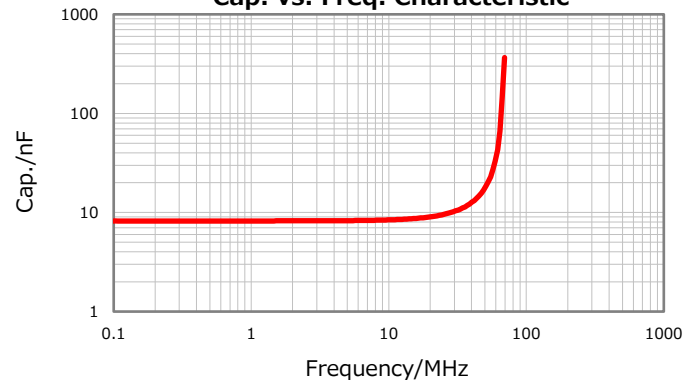

Ripple Temperature Rise Characteristics

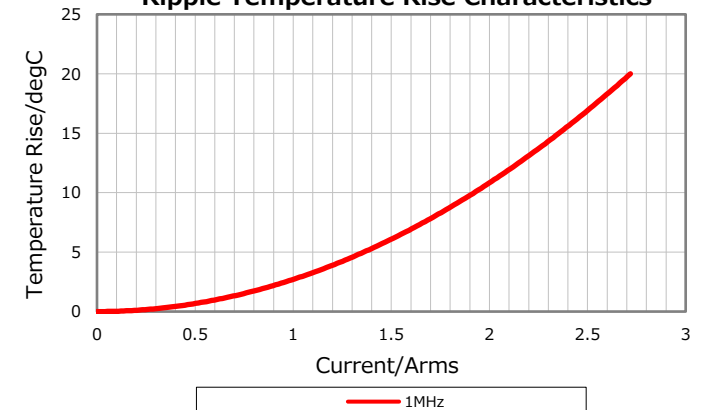

Characterization Sheet (Multilayer Ceramic Chip Capacitors)



All specifications are subject to change without notice.

May 21, 2019