

C1608X5R1H472K080AA

TDK item description : C1608X5R1H472KT****



Application & Main Feature

Commercial grade (General type)

Series

C1608 [EIA 0603]

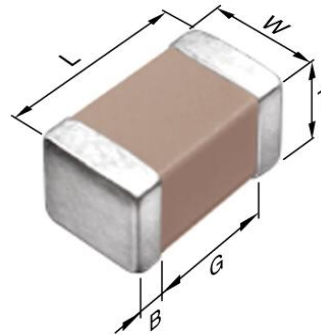

Dimensions

L 1.60±0.10 mm
 W 0.80±0.10 mm
 T 0.80±0.10 mm
 B 0.20 mm min.
 G 0.30 mm min.

Temperature Characteristic

X5R (-55 to +85 degC, ±15%)

Rated Voltage

1H (50Vdc)

Capacitance

4.7nF

Capacitance Tolerance

K (±10%)

DF

3 % max.

Insulation Resistance

10000 Mohm min.

AEC-Q200

Not Applicable

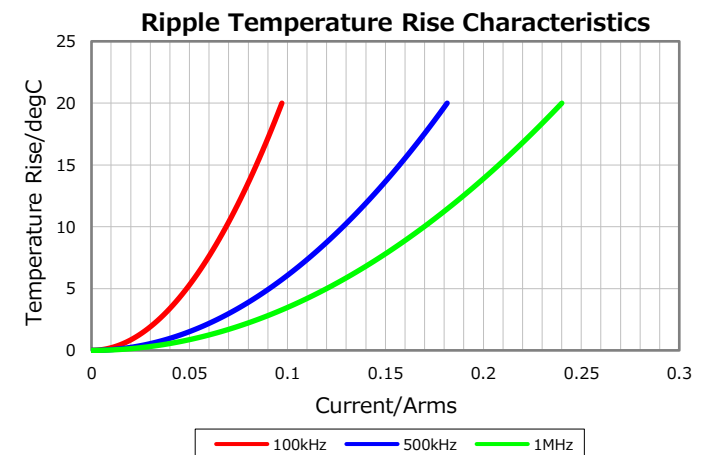
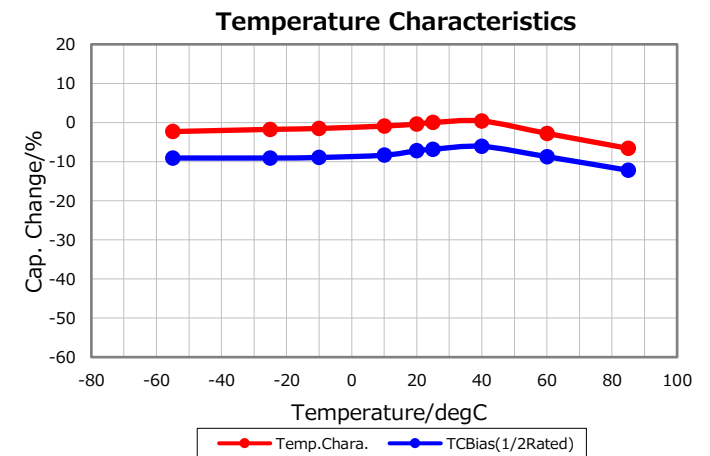
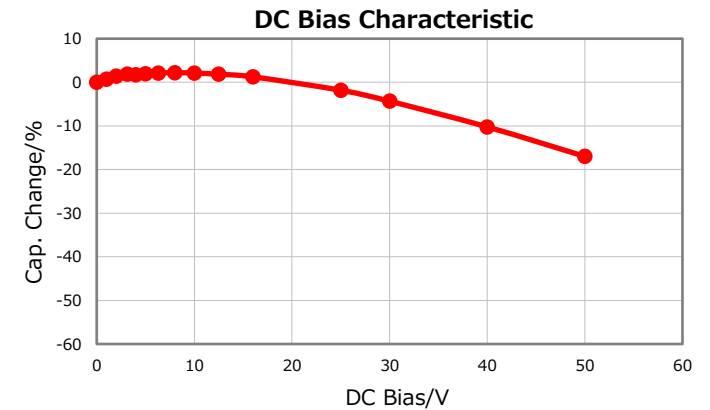
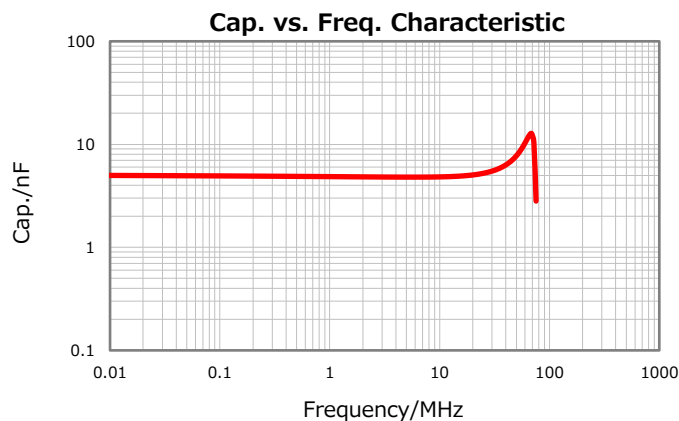
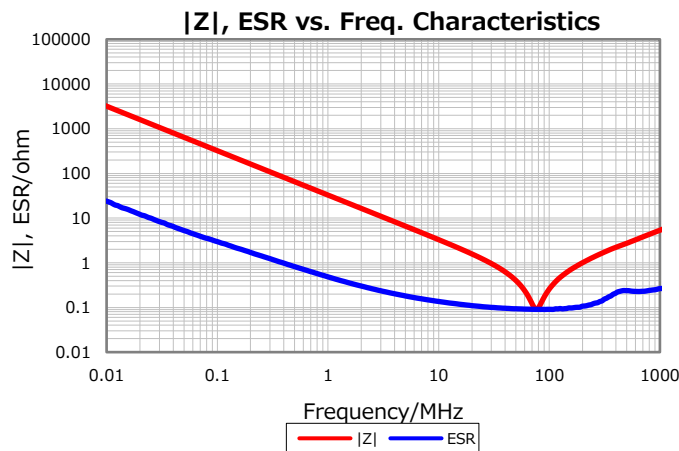

Characterization Sheet (Multilayer Ceramic Chip Capacitors)



All specifications are subject to change without notice.

March 21, 2020