

Application & Main Feature

Commercial Grade (Soft Termination)

Series

C2012 [EIA CC0805]

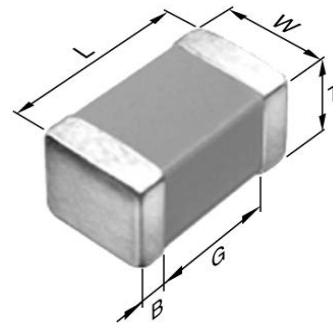

Dimensions

L	2.00mm +0.45,-0.2mm
W	1.25mm +0.25,-0.2mm
T	0.60mm +/-0.15mm
B	0.20mm Min.
G	0.50mm Min.

Temperature Characteristic

C0G (-55 to 125 degC 0+/-30ppm/degC)

Rated Voltage

2W (450Vdc)

Capacitance

470pF

Capacitance Tolerance

J (+/-5%)

Q Factor

1000 Min.

Insulation Resistance

10Gohm Min

AEC-Q200

Not Applicable

|Z|, ESR vs. Freq. Characteristics
(Simulation Data)

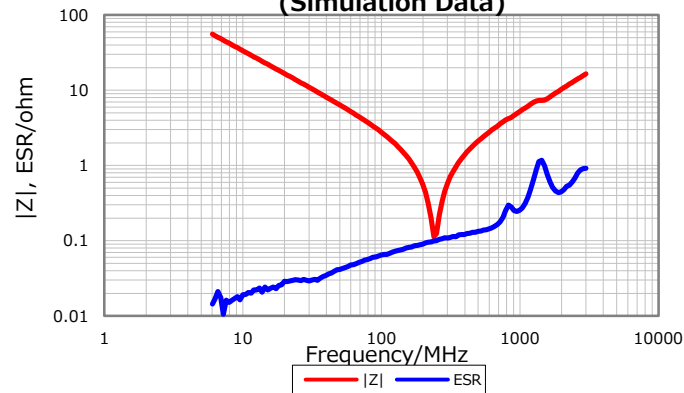

Cap. vs. Freq. Characteristic

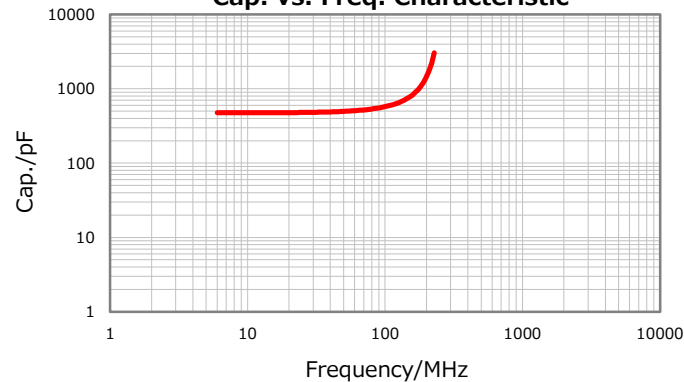

DC Bias Characteristic

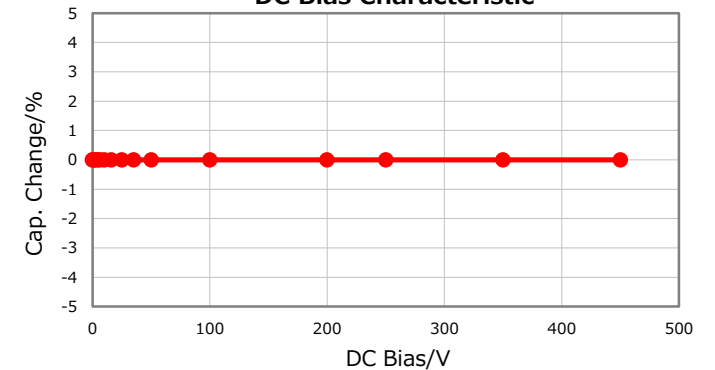

Temperature Characteristics

