

C3216C0G2J821J085AA

TDK Item Description : C3216C0G2J821JT****



Application & Main Feature

Commercial Grade (Mid Voltage (100 to 630V))

Series

C3216 [EIA CC1206]

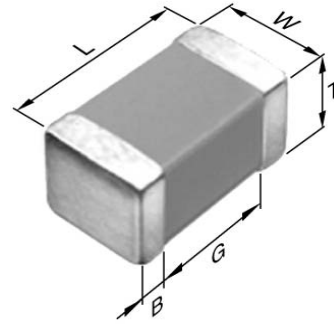

Dimensions

L 3.20mm +/-0.2mm
 W 1.60mm +/-0.2mm
 T 0.85mm +/-0.15mm
 B 0.20mm Min.
 G 1.00mm Min.

Temperature Characteristic

C0G (-55 to 125 degC 0+/-30ppm/degC)

Rated Voltage

2J (630Vdc)

Capacitance

820pF

Capacitance Tolerance

J (+/-5%)

Q Factor

1000 Min.

Insulation Resistance

10Gohm Min.

AEC-Q200

Not Applicable

|Z|, ESR vs. Freq. Characteristics

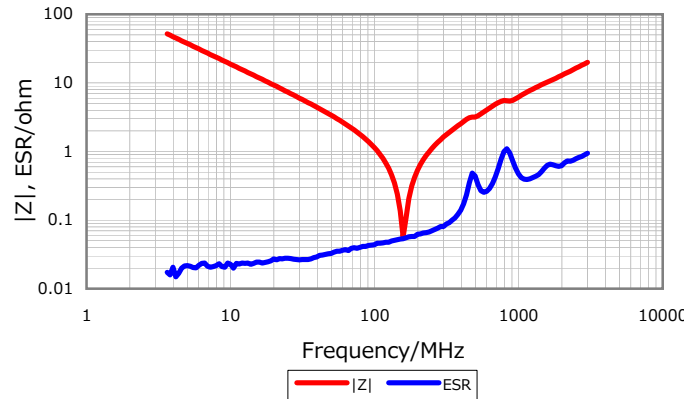

DC Bias Characteristic

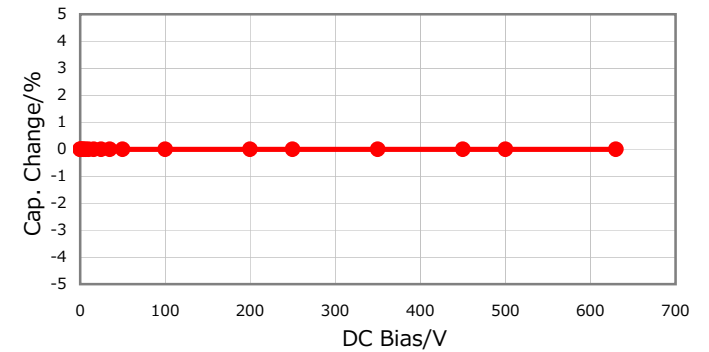

Cap. vs. Freq. Characteristic

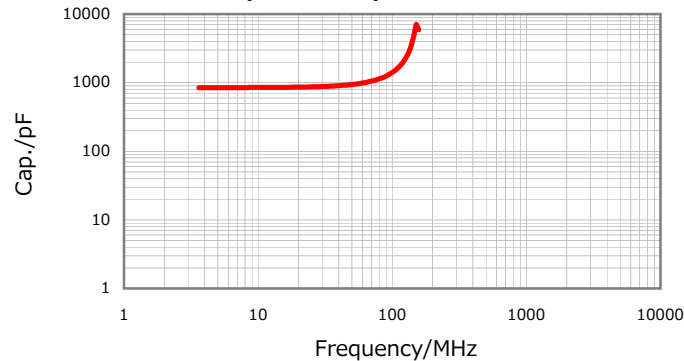

Temperature Characteristics



Characterization Sheet (Multilayer Ceramic Chip Capacitors)



All specifications are subject to change without notice.

January 3, 2016