

# C3216C0G2W822K115AA

TDK Item Description : C3216C0G2W822KT\*\*\*\*



## Application & Main Feature

Commercial Grade ( Mid Voltage (100 to 630V) )

## Series

C3216 [EIA CC1206]

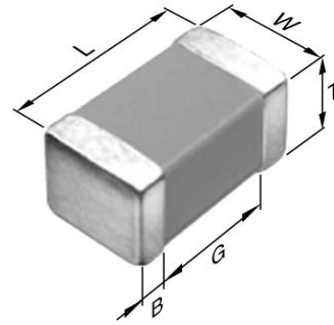

## Dimensions

L 3.20mm +/-0.2mm  
 W 1.60mm +/-0.2mm  
 T 1.15mm +/-0.15mm  
 B 0.20mm Min.  
 G

## Temperature Characteristic

C0G (-55 to 125 degC 0+/-30ppm/degC)

## Rated Voltage

2W (450Vdc)

## Capacitance

8.2nF

## Capacitance Tolerance

K (+/-10%)

## Q Factor

1000 Min.

## Insulation Resistance

10Gohm Min.

## AEC-Q200

Not Applicable

**|Z|, ESR vs. Freq. Characteristics**

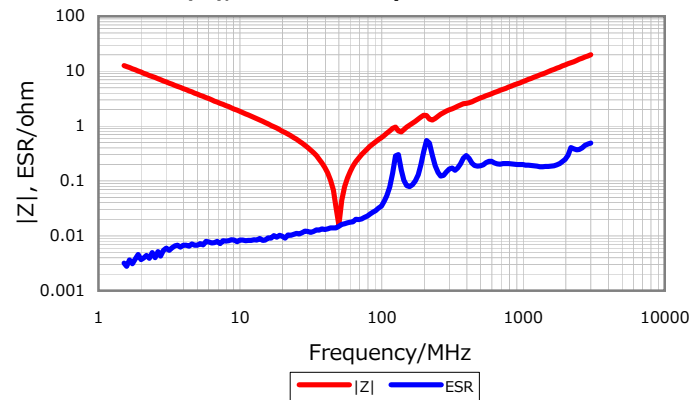

**DC Bias Characteristic**

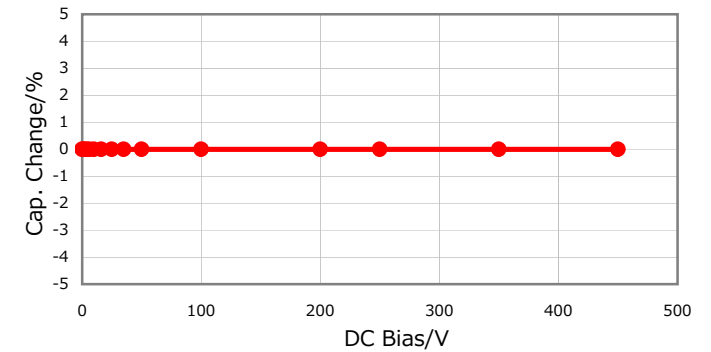

**Cap. vs. Freq. Characteristic**

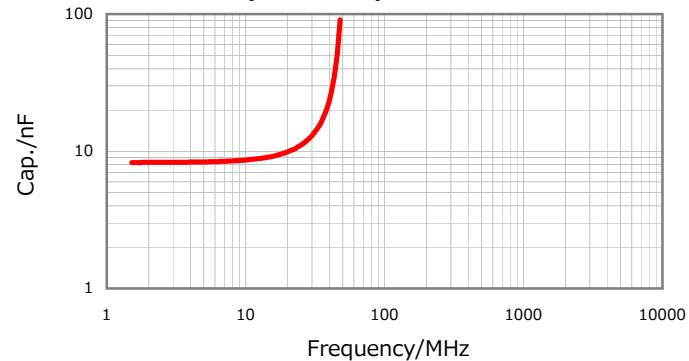

**Temperature Characteristics**

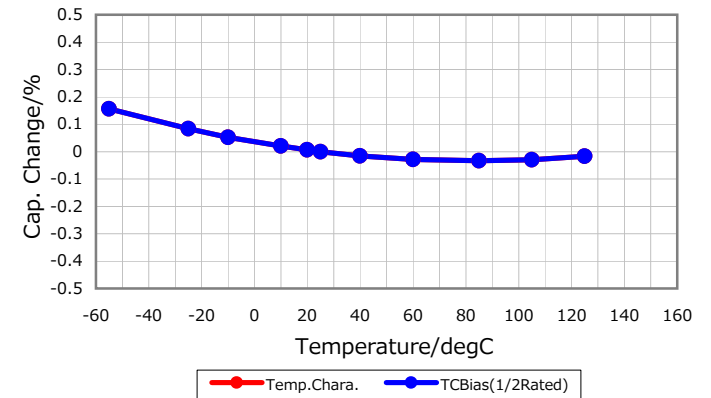

Characterization Sheet ( Multilayer Ceramic Chip Capacitors )



All specifications are subject to change without notice.

January 3, 2016