

CAA572X7T2V225M640LH

TDK item description : CAA572X7T2V225MT****



Application & Main Feature

Commercial grade (MEGACAP (Low resistance/Inline))

Series

CAA572(5750) [EIA 2220]

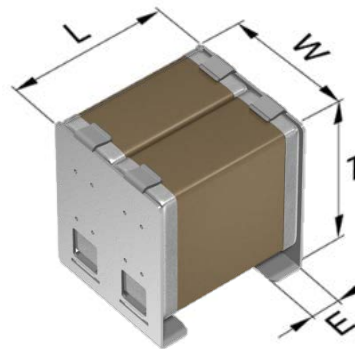

Dimensions

L 6.00±0.50 mm
 W 5.00±0.50 mm
 T 6.40±0.50 mm
 E 1.20±0.20 mm

Temperature Characteristic

X7T (-55 to +125 degC, +22/-33%)

Rated Voltage

2V (350Vdc)

Capacitance

2.2µF

Capacitance Tolerance

M (±20%)

DF

2.5 % max.

Insulation Resistance

227 Mohm min.

AEC-Q200

Not Applicable

Characterization Sheet (Multilayer Ceramic Chip Capacitors)

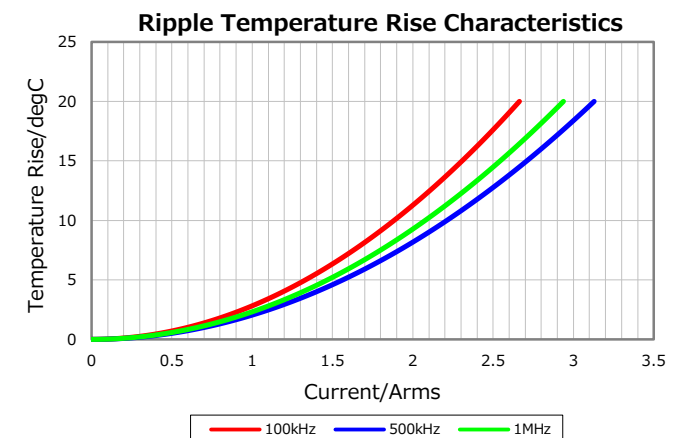
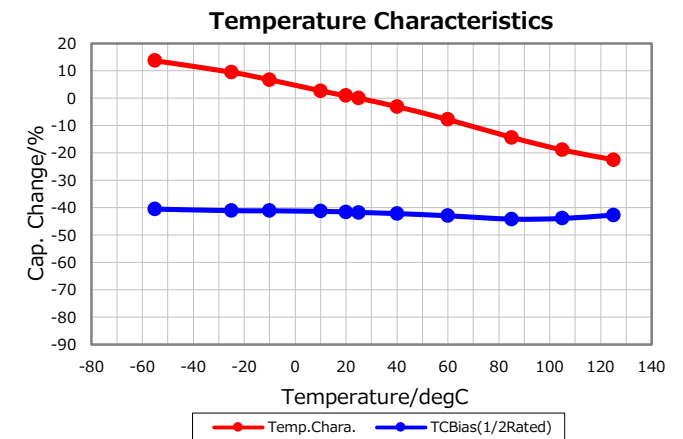
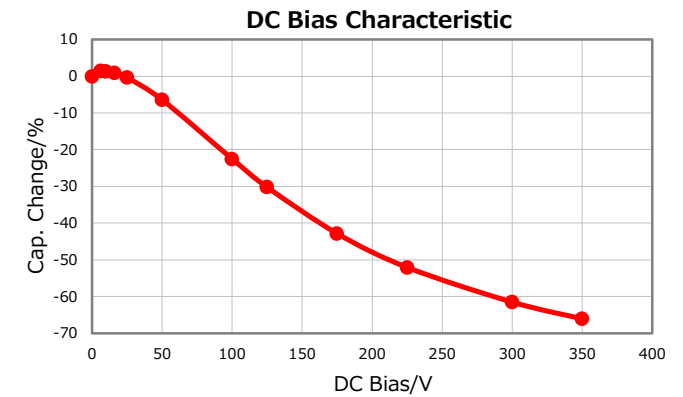
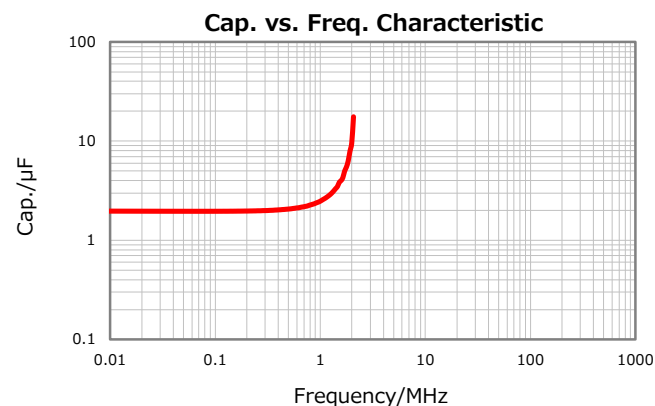
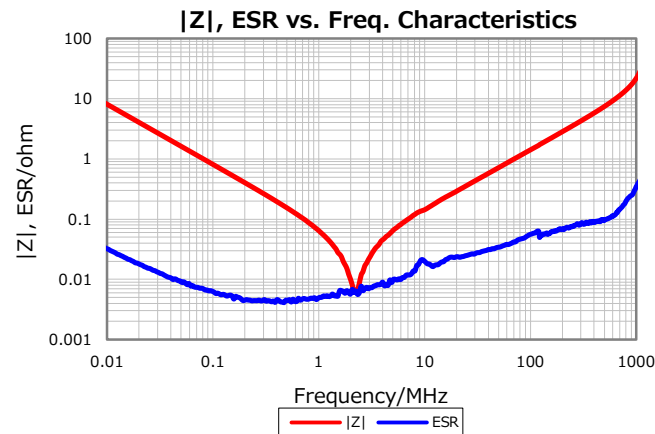

All specifications are subject to change without notice.

August 20, 2022