

CGA2B2NP02A221J050BA

TDK Item Description : CGA2B2NP02A221T****



Equivalent C1005NP02A221J for Automotive

Application & Main Feature

Automotive Grade (High Temperature Application)

Series

CGA2(1005) [EIA CC0402]

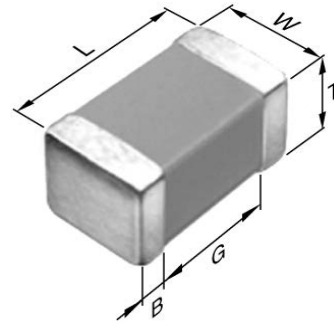

Dimensions

L	1.00mm +/-0.05mm
W	0.50mm +/-0.05mm
T	0.50mm +/-0.05mm
B	0.10mm Min.
G	0.3mm Min.

Temperature Characteristic

NP0 (-55 to 150 degC 0+/-30ppm/degC)

Rated Voltage

2A (100Vdc)

Capacitance

220pF

Capacitance Tolerance

J (+/-5%)

Q Factor

1000 Min.

Insulation Resistance

10Gohm Min

AEC-Q200

Yes

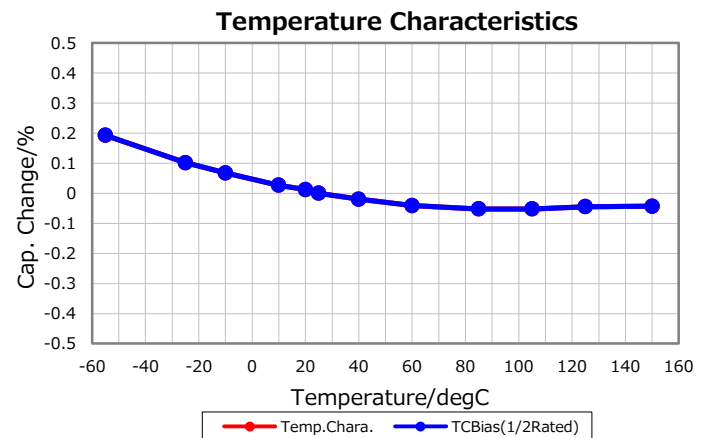
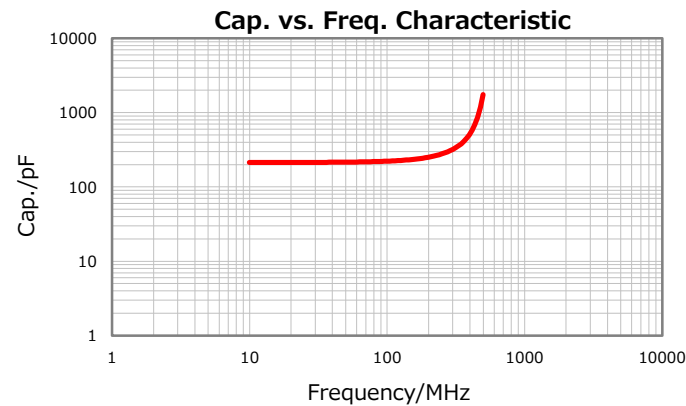
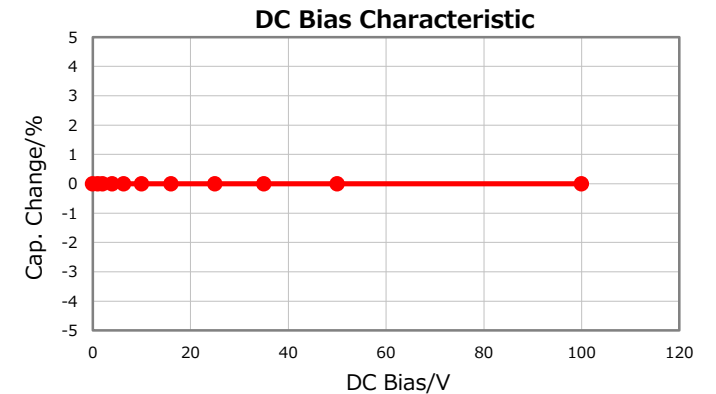
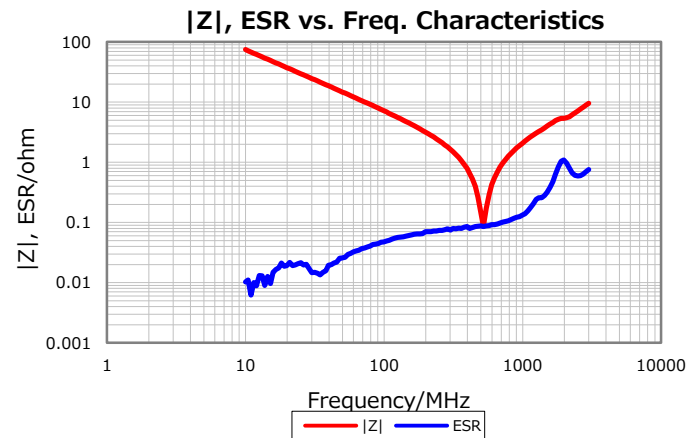

Characterization Sheet (Multilayer Ceramic Chip Capacitors)



All specifications are subject to change without notice.

April 13, 2016