

# CGA2B2X5R1C333K050BA

TDK Item Description : CGA2B2X5R1C333KT\*\*\*\*



Equivalent C1005X5R1C333K for Automotive

## Application & Main Feature

Automotive Grade ( General (Up to 50V) )

## Series

CGA2(1005) [EIA CC0402]

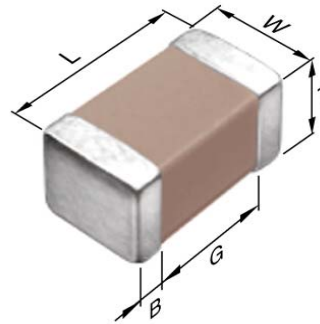

## Dimensions

L 1.00mm +/-0.05mm  
 W 0.50mm +/-0.05mm  
 T 0.50mm +/-0.05mm  
 B 0.10mm Min.  
 G 0.30mm Min.

## Temperature Characteristic

X5R (-55 to 85 degC +/-15%)

## Rated Voltage

1C (16Vdc)

## Capacitance

33nF

## Capacitance Tolerance

K (+/-10%)

## Dissipation Factor

5% Max.

## Insulation Resistance

3.03Gohm Min.

## AEC-Q200

Yes

## DC Bias Characteristic

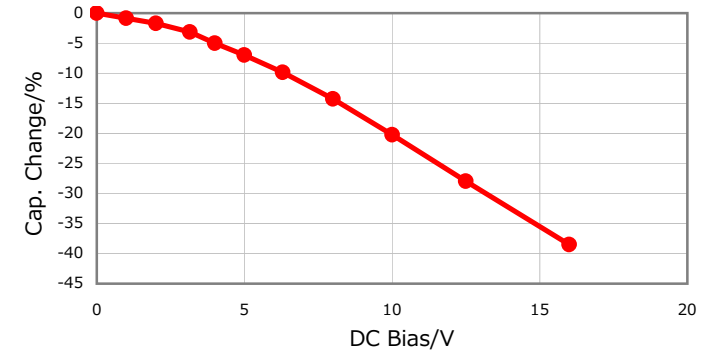

## |Z|, ESR vs. Freq. Characteristics

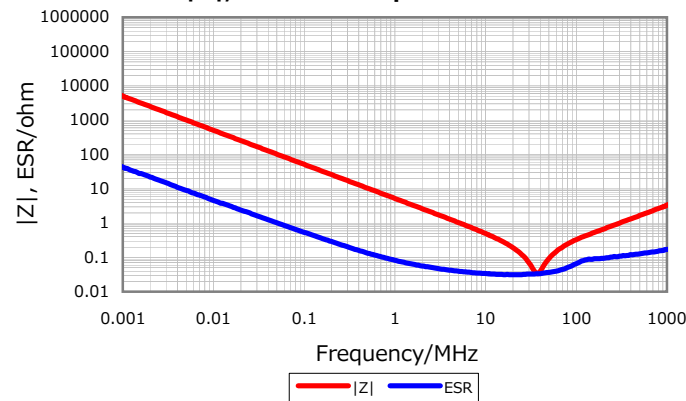

## Temperature Characteristics

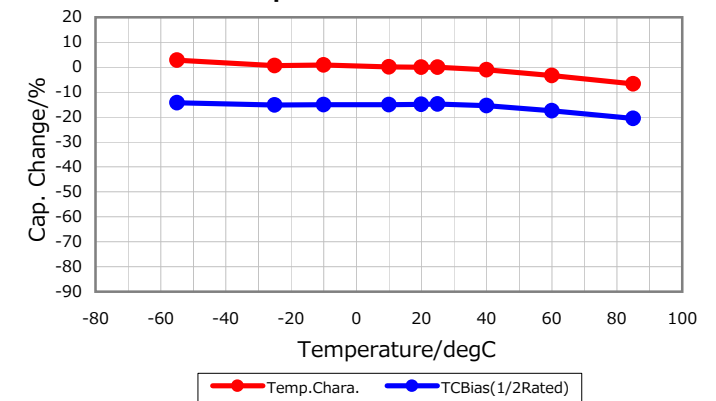

## Cap. vs. Freq. Characteristic

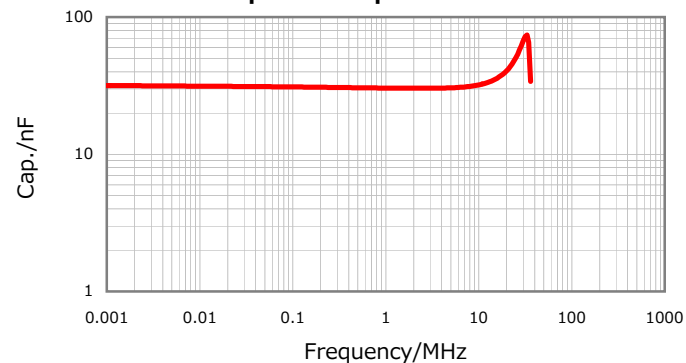

## Ripple Temperature Rise Characteristics

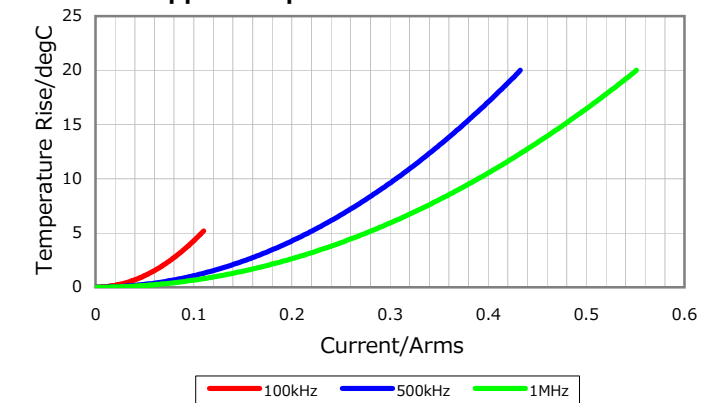

Characterization Sheet ( Multilayer Ceramic Chip Capacitors )



All specifications are subject to change without notice.

January 4, 2016