

# CGA2B2X8R2A471K050BA

TDK Item Description : CGA2B2X8R2A471KT\*\*\*\*



Equivalent C1005X8R2A471K for Automotive

## Application & Main Feature

Automotive Grade ( High Temperature Application )

## Series

CGA2(1005) [EIA 0402]

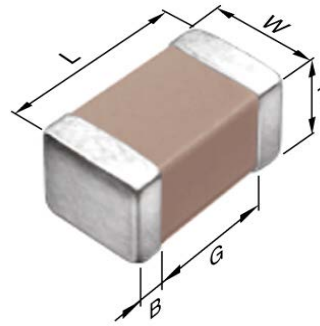

## Dimensions

L	1.00mm +/-0.05mm
W	0.50mm +/-0.05mm
T	0.50mm +/-0.05mm
B	0.10mm Min.
G	0.30mm Min.

## Temperature Characteristic

X8R (-55 to 150 degC +/-15%)

## Rated Voltage

2A (100Vdc)

## Capacitance

470pF

## Capacitance Tolerance

K (+/-10%)

## Dissipation Factor

3% Max.

## Insulation Resistance

10Gohm Min

## AEC-Q200

Yes

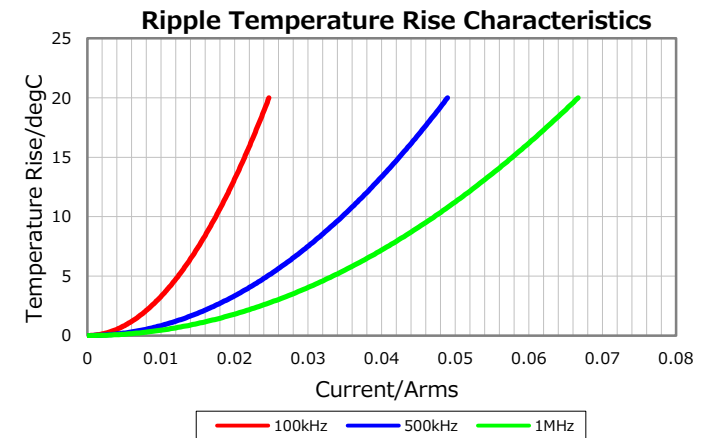
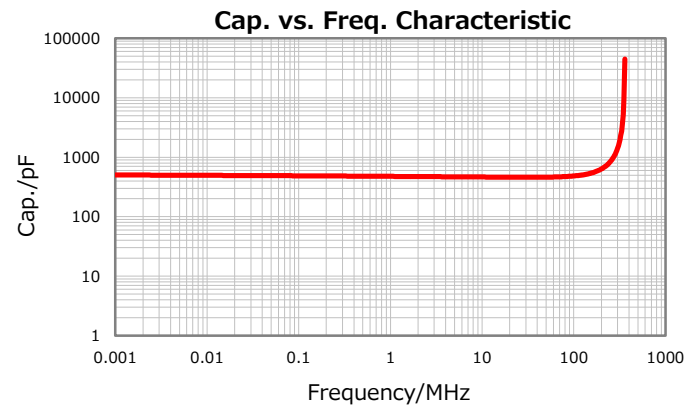
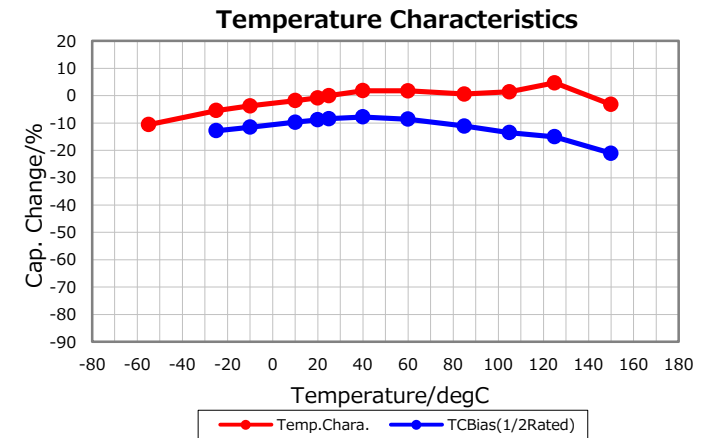
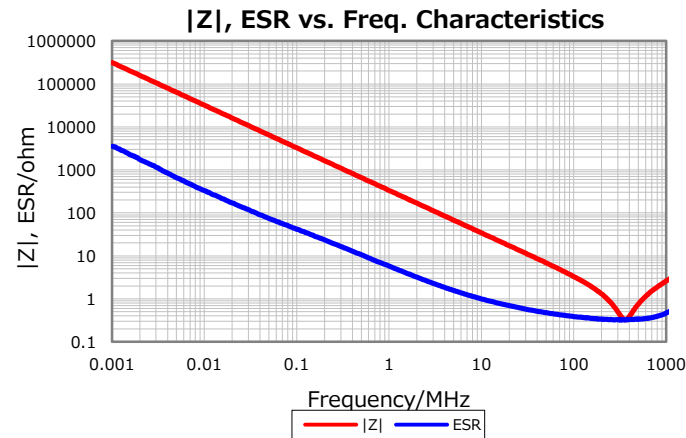
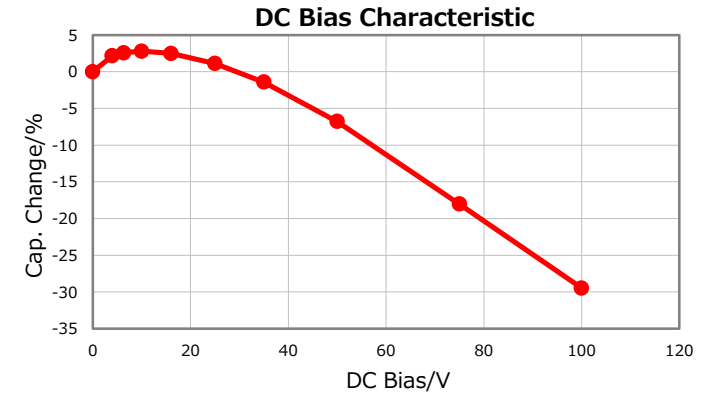

Characterization Sheet ( Multilayer Ceramic Chip Capacitors )



All specifications are subject to change without notice.

July 6, 2016