

CGA2B3X7R1H473K050BE

TDK Item Description : CGA2B3X7R1H473KT***S



Equivalent C1005X7R1H473K for Automotive

Application & Main Feature

Automotive Grade (Soft Termination)

Series

CGA2(1005) [EIA CC0402]

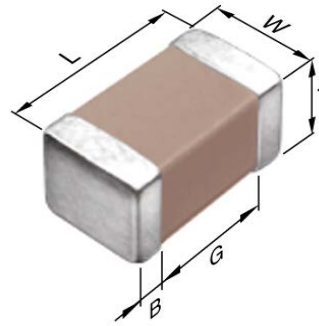

Dimensions

L	1.00mm +0.15,-0.05mm
W	0.50mm +0.1,-0.05mm
T	0.50mm +0.1,-0.05mm
B	0.10mm Min.
G	0.30mm Min.

Temperature Characteristic

X7R (-55 to 125 degC +/-15%)

Rated Voltage

1H (50Vdc)

Capacitance

47nF

Capacitance Tolerance

K (+/-10%)

Dissipation Factor

5% Max.

Insulation Resistance

10Gohm Min

AEC-Q200

Yes

|Z|, ESR vs. Freq. Characteristics (Simulation Data)

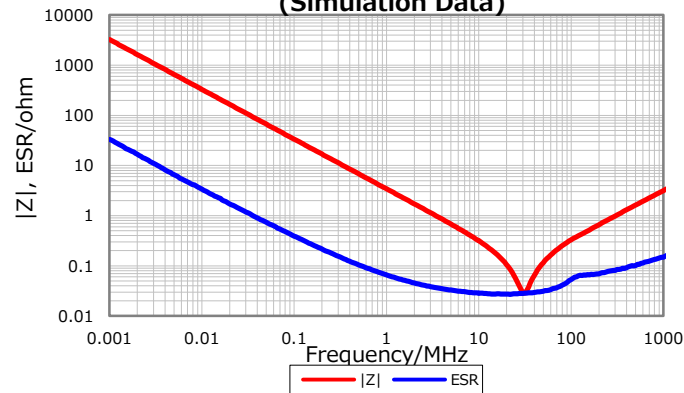

Cap. vs. Freq. Characteristic

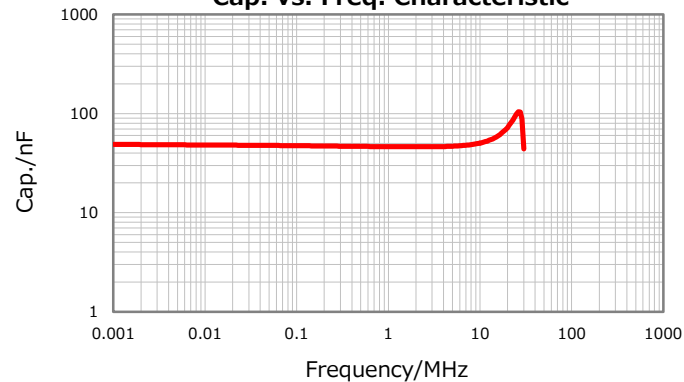

DC Bias Characteristic

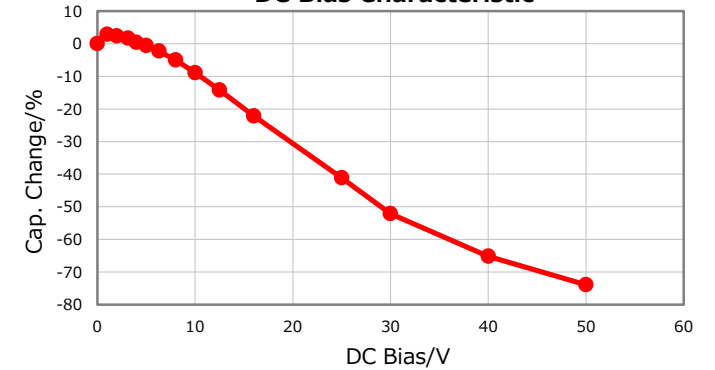

Temperature Characteristics

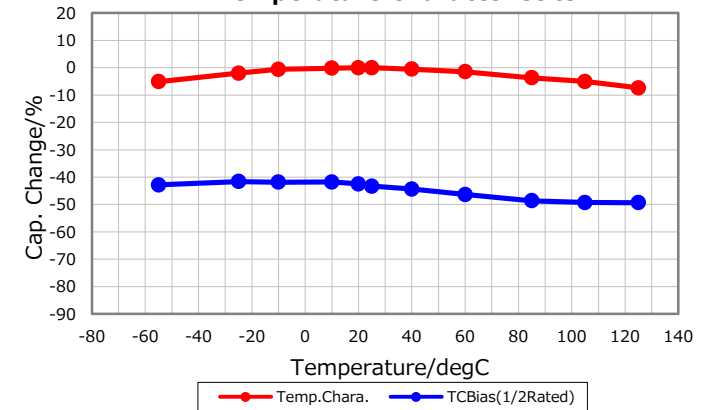

Ripple Temperature Rise Characteristics

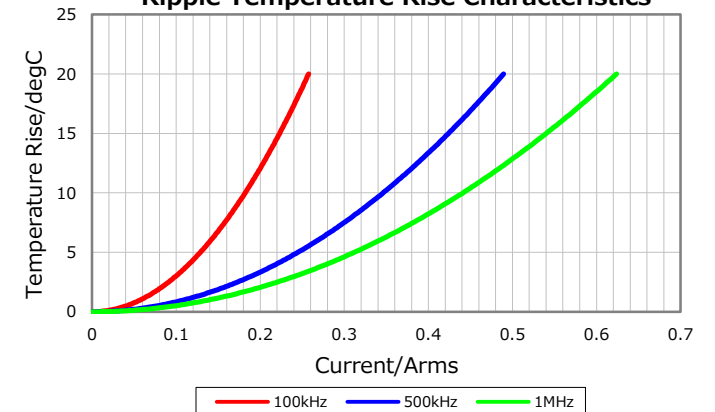

Characterization Sheet (Multilayer Ceramic Chip Capacitors)



All specifications are subject to change without notice.

March 16, 2017