

CGA2B3X7S1A334K050BB

TDK item description : CGA2B3X7S1A334KT****



Equivalent C1005X7S1A334K for Automotive

Application & Main Feature

Automotive grade (General type)

Series

CGA2(1005) [EIA 0402]

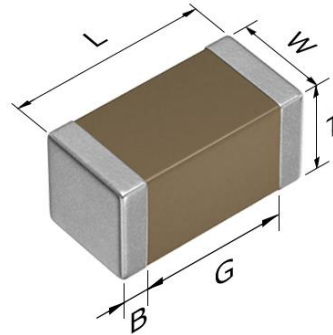

Dimensions

L 1.00±0.05 mm
 W 0.50±0.05 mm
 T 0.50±0.05 mm
 B 0.10 mm min.
 G 0.30 mm min.

Temperature Characteristic

X7S (-55 to +125 degC, ±22%)

Rated Voltage

1A (10Vdc)

Capacitance

330nF

Capacitance Tolerance

K (±10%)

DF

7.5 % max.

Insulation Resistance

303 Mohm min.

AEC-Q200

Yes

Characterization Sheet (Multilayer Ceramic Chip Capacitors)

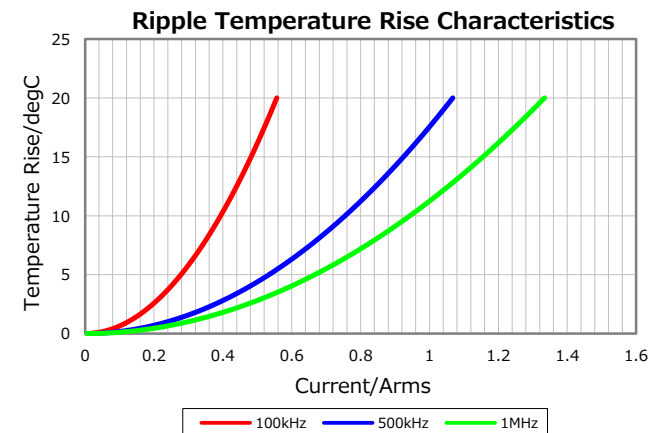
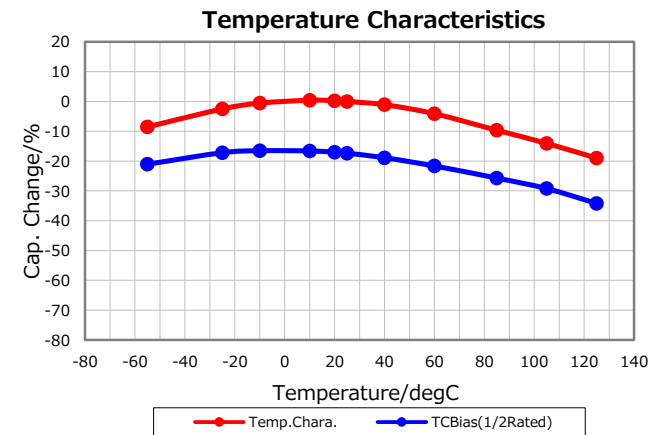
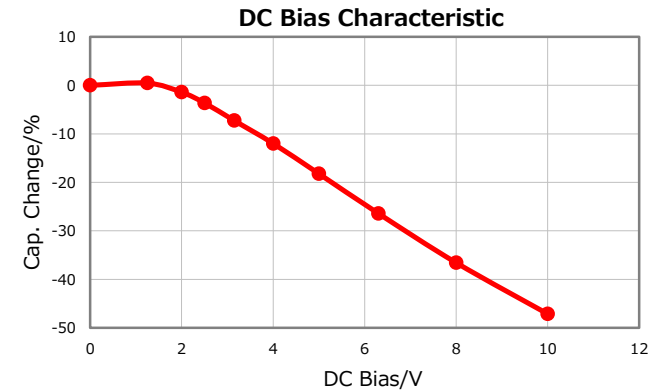
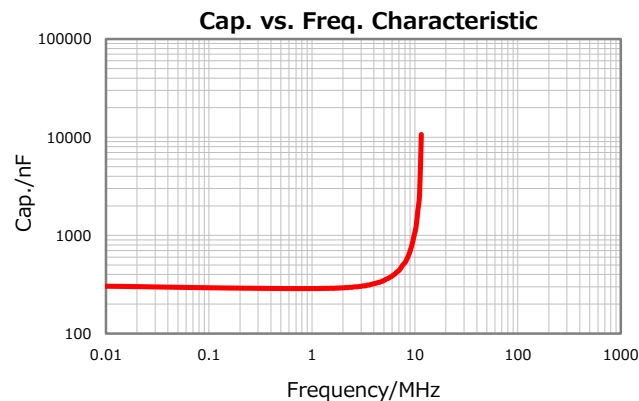
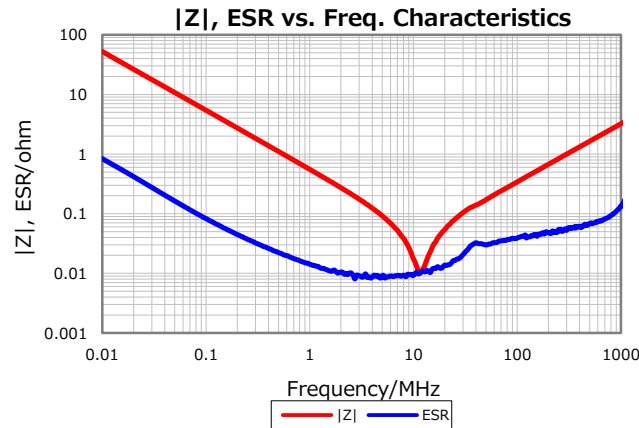

⚠ All specifications are subject to change without notice.

January 4, 2021