

CGA3E2X5R1H153K080AA

TDK Item Description : CGA3E2X5R1H153KT****



Equivalent C1608X5R1H153K for Automotive

Application & Main Feature

Automotive Grade (General (Up to 50V))

Series

CGA3(1608) [EIA CC0603]

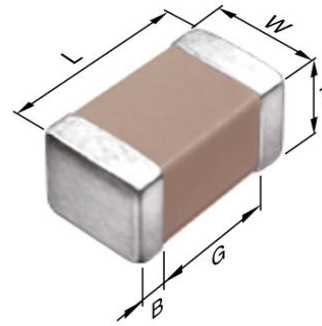

Dimensions

L 1.60mm +/-0.1mm
 W 0.80mm +/-0.1mm
 T 0.80mm +/-0.1mm
 B 0.20mm Min.
 G 0.30mm Min.

Temperature Characteristic

X5R (-55 to 85 degC +/-15%)

Rated Voltage

1H (50Vdc)

Capacitance

15nF

Capacitance Tolerance

K (+/-10%)

Dissipation Factor

3% Max.

Insulation Resistance

10Gohm Min.

AEC-Q200

Yes

DC Bias Characteristic

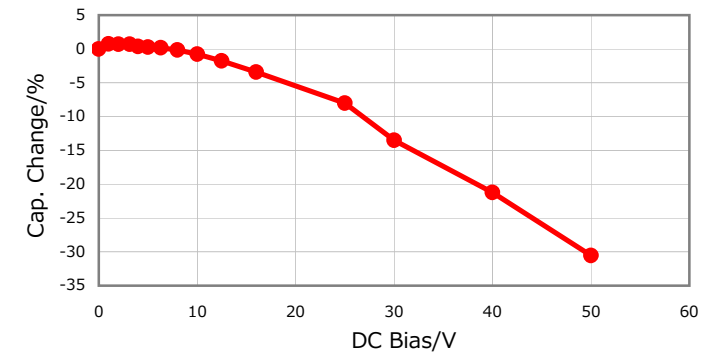

|Z|, ESR vs. Freq. Characteristics

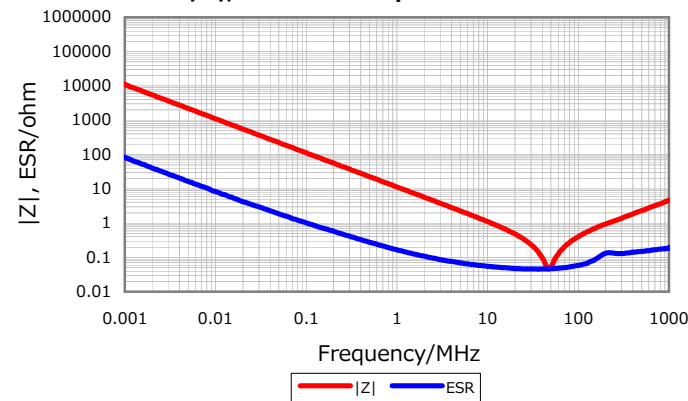

Temperature Characteristics

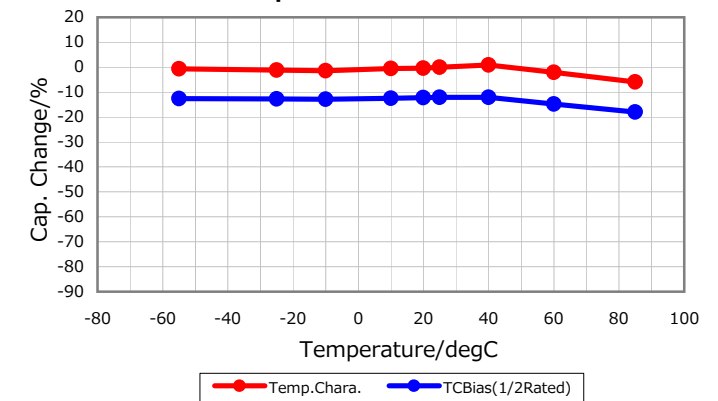

Cap. vs. Freq. Characteristic

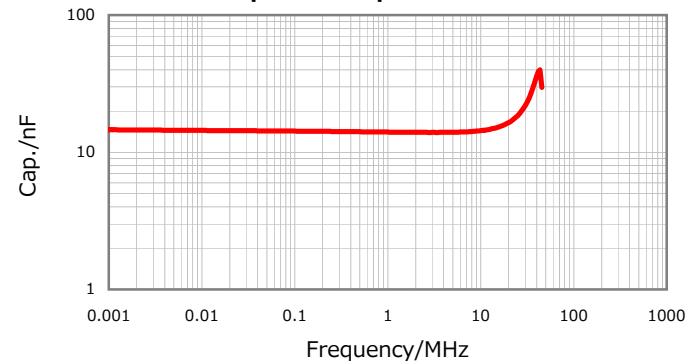

Ripple Temperature Rise Characteristics

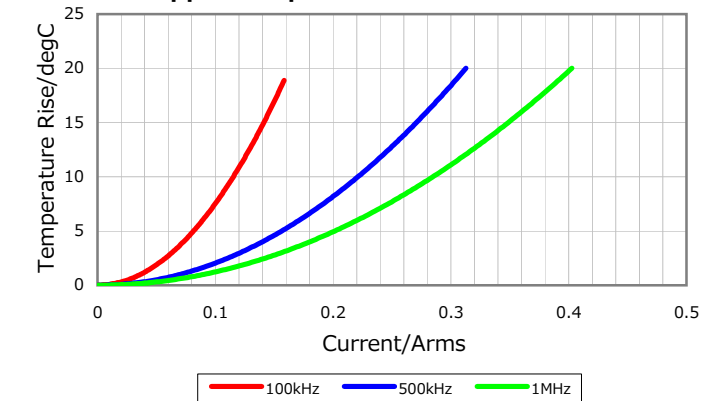

Characterization Sheet (Multilayer Ceramic Chip Capacitors)



All specifications are subject to change without notice.

January 4, 2016