

CGA3E2X5R1H222K080AA

TDK item description : CGA3E2X5R1H222KT***



Equivalent C1608X5R1H222K for Automotive

Application & Main Feature

Automotive grade (General type)

Series

CGA3(1608) [EIA 0603]

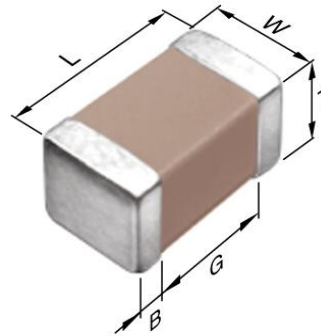

Dimensions

L	1.60±0.10 mm
W	0.80±0.10 mm
T	0.80±0.10 mm
B	0.20 mm min.
G	0.30 mm min.

Temperature Characteristic

X5R (-55 to +85 degC, ±15%)

Rated Voltage

1H (50Vdc)

Capacitance

2.2nF

Capacitance Tolerance

K (±10%)

DF

3 % max.

Insulation Resistance

10000 Mohm min.

AEC-Q200

Yes

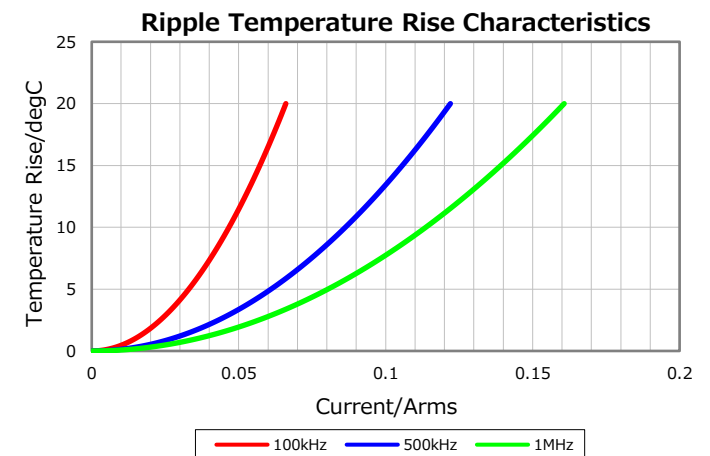
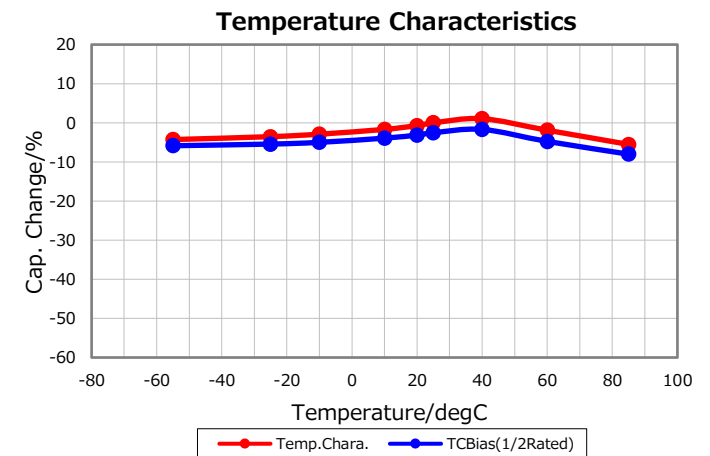
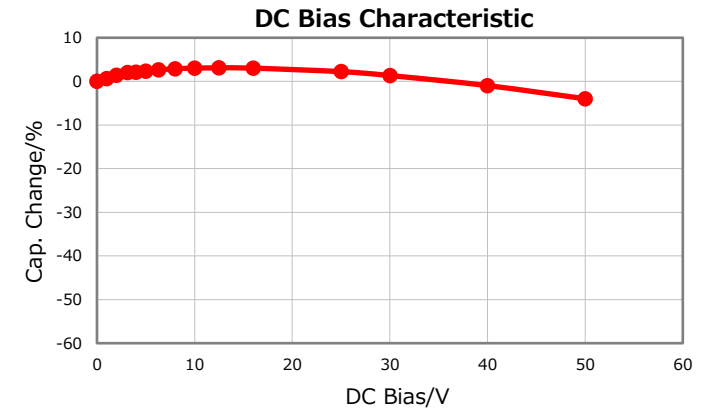
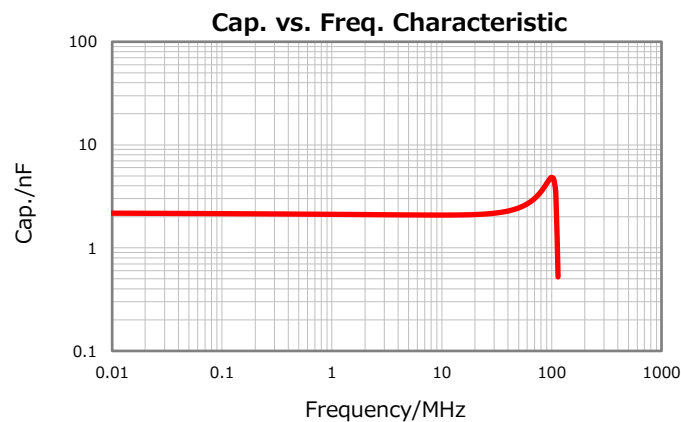
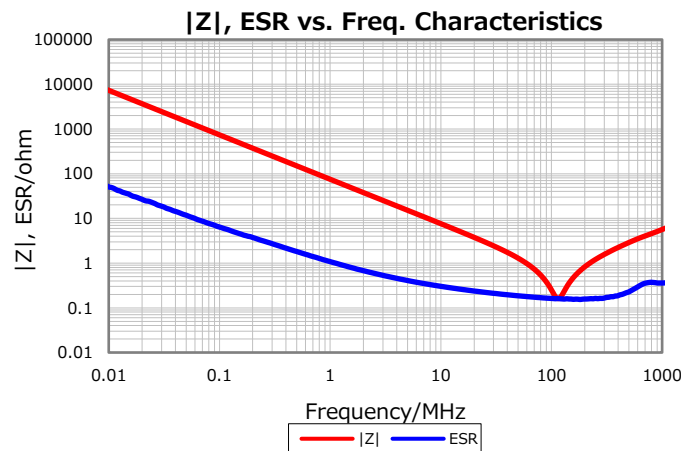

Characterization Sheet (Multilayer Ceramic Chip Capacitors)



All specifications are subject to change without notice.

March 24, 2020