

# CGA3E3X5R1E334K080AB

TDK item description : CGA3E3X5R1E334KT\*\*\*\*



Equivalent C1608X5R1E334K for Automotive

## Application & Main Feature

Automotive grade (General type)

## Series

CGA3(1608) [EIA 0603]

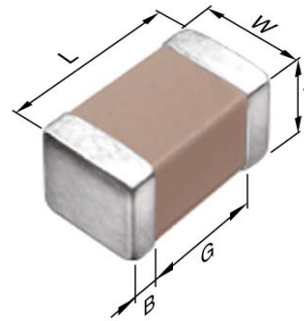

## Dimensions

L	1.60±0.10 mm
W	0.80±0.10 mm
T	0.80±0.10 mm
B	0.20 mm min.
G	0.30 mm min.

## Temperature Characteristic

X5R (-55 to +85 degC, ±15%)

## Rated Voltage

1E (25Vdc)

## Capacitance

330nF

## Capacitance Tolerance

K (±10%)

## Dissipation Factor

5 % max.

## Insulation Resistance

1515 Mohm min.

## AEC-Q200

Yes

Characterization Sheet ( Multilayer Ceramic Chip Capacitors )

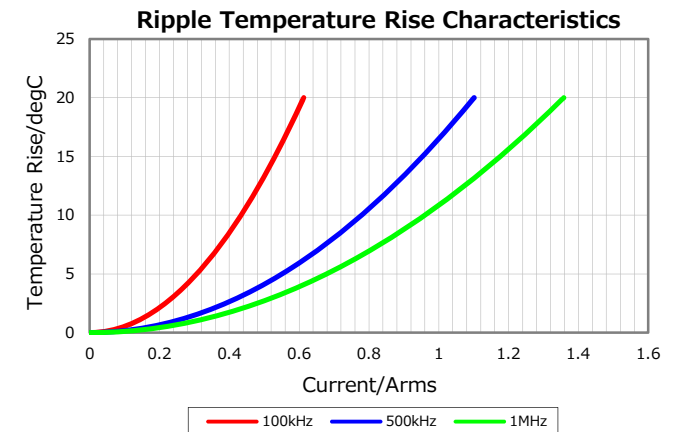
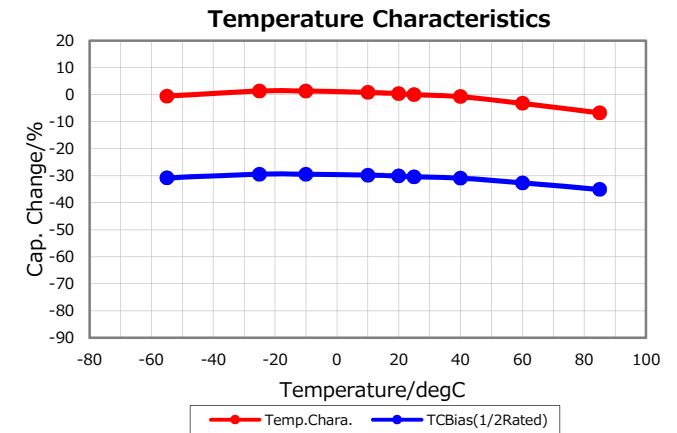
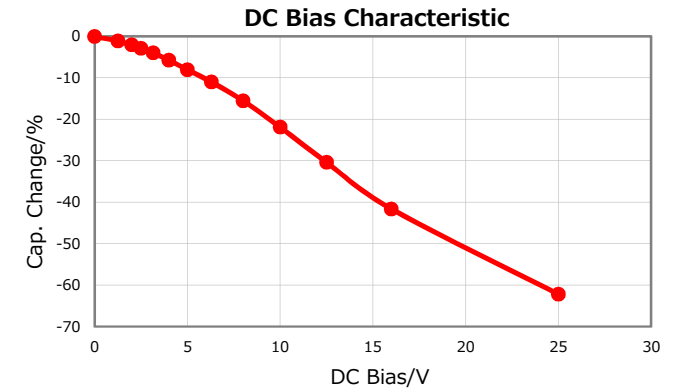
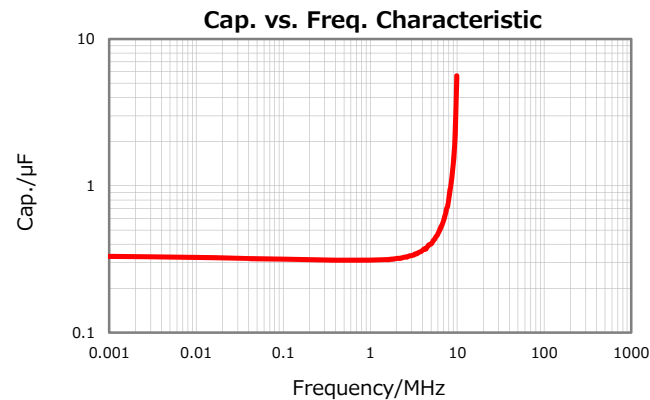
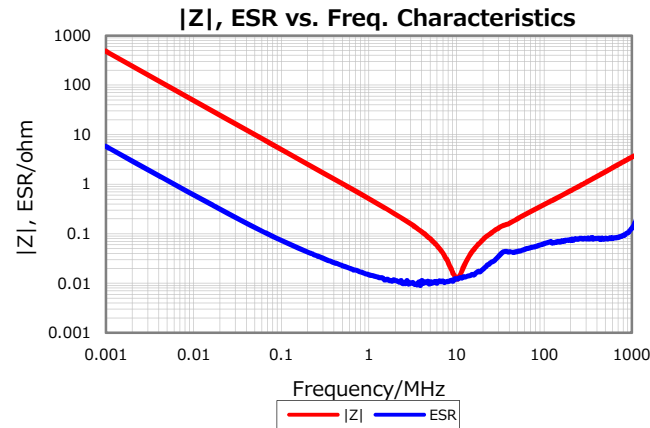

All specifications are subject to change without notice.

January 10, 2020