

CGA3E3X8R1H104K080AE

TDK Item Description : CGA3E3X8R1H104KT***S



Equivalent C1608X8R1H104K for Automotive

Application & Main Feature

Automotive Grade (Soft Termination)

Series

CGA3(1608) [EIA CC0603]

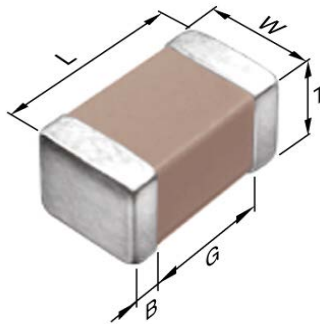

Dimensions

L	1.60mm +0.2,-0.1mm
W	0.80mm +0.15,-0.1mm
T	0.80mm +0.15,-0.1mm
B	0.20mm Min.
G	0.30mm Min.

Temperature Characteristic

X8R (-55 to 150 degC +/-15%)

Rated Voltage

1H (50Vdc)

Capacitance

100nF

Capacitance Tolerance

K (+/-10%)

Dissipation Factor

3% Max.

Insulation Resistance

5Gohm Min

AEC-Q200

Yes

|Z|, ESR vs. Freq. Characteristics (Simulation Data)

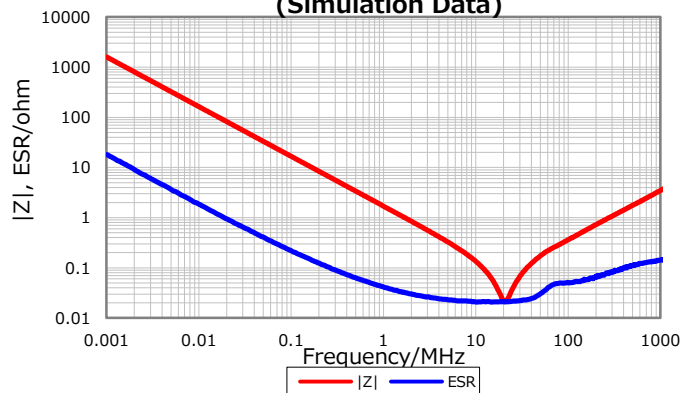

Cap. vs. Freq. Characteristic

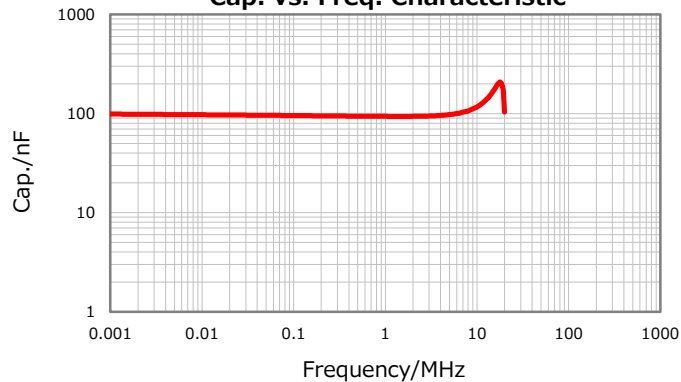

DC Bias Characteristic

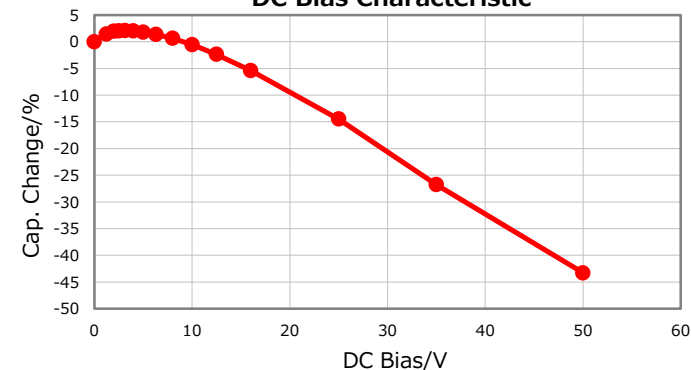

Temperature Characteristics

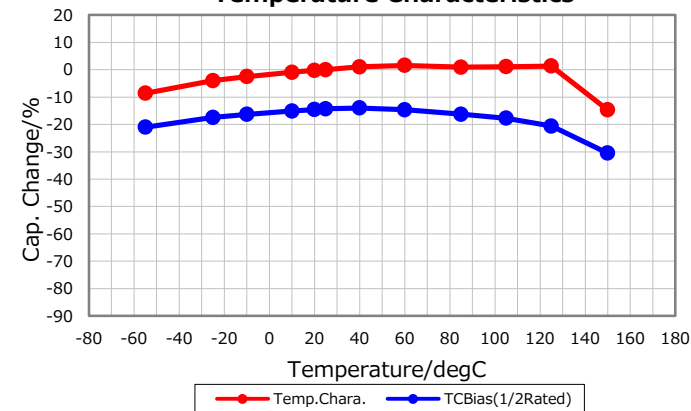

Ripple Temperature Rise Characteristics

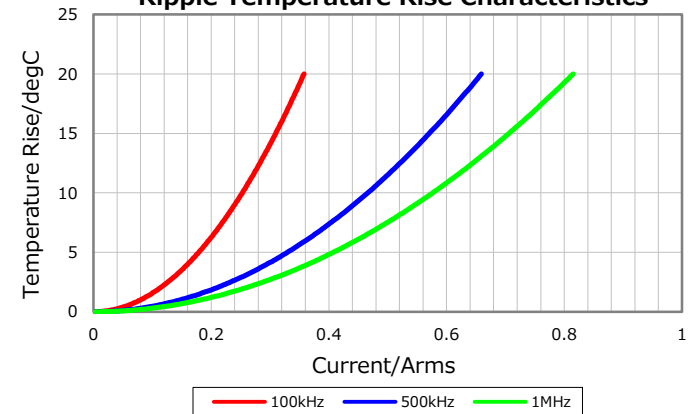

Characterization Sheet (Multilayer Ceramic Chip Capacitors)



All specifications are subject to change without notice.

March 17, 2017