

CGA4J1X8L1C475K125AC

TDK item description : CGA4J1X8L1C475KT****



Equivalent C2012X8L1C475K for Automotive

Application & Main Feature

Automotive grade (General type)

Series

CGA4(2012) [EIA 0805]

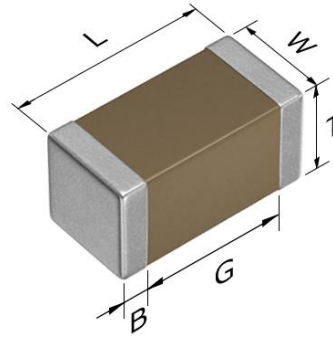

Dimensions

L 2.00±0.20 mm
 W 1.25±0.20 mm
 T 1.25±0.20 mm
 B 0.20 mm min.
 G 0.50 mm min.

Temperature Characteristic

X8L (-55 to +150 degC, +15/-40%)

Rated Voltage

1C (16Vdc)

Capacitance

4.7µF

Capacitance Tolerance

K (±10%)

DF

5 % max.

Insulation Resistance

21 Mohm min.

AEC-Q200

Yes

Characterization Sheet (Multilayer Ceramic Chip Capacitors)

DC Bias Characteristic

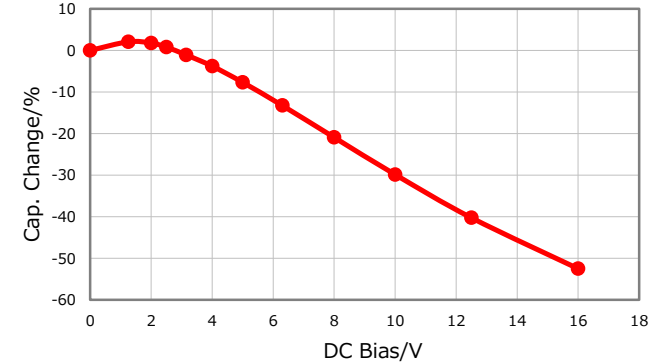

|Z|, ESR vs. Freq. Characteristics

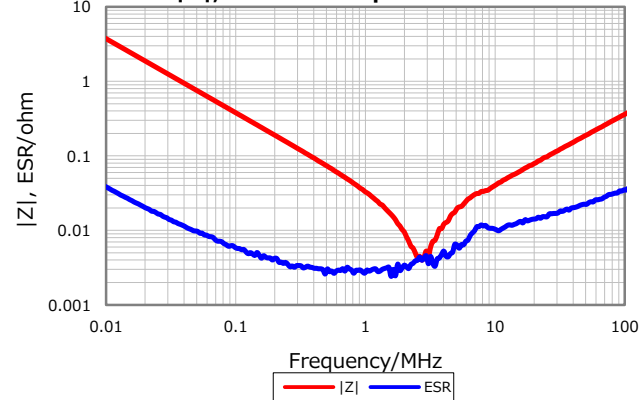

Temperature Characteristics

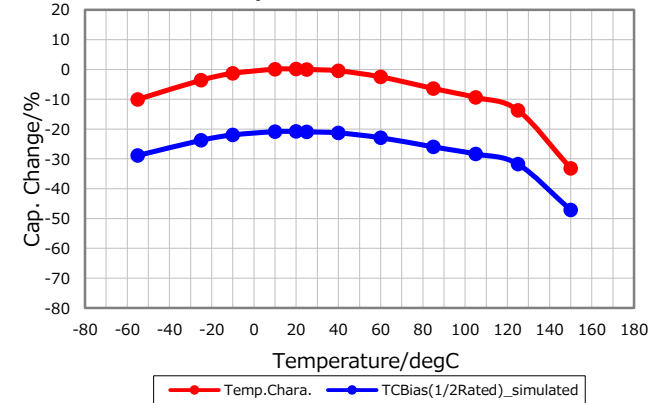

Cap. vs. Freq. Characteristic

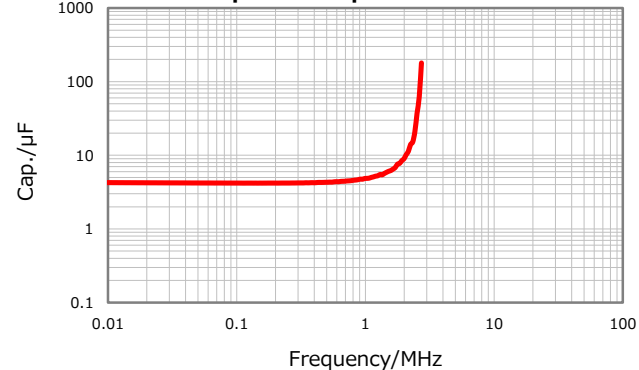

Ripple Temperature Rise Characteristics

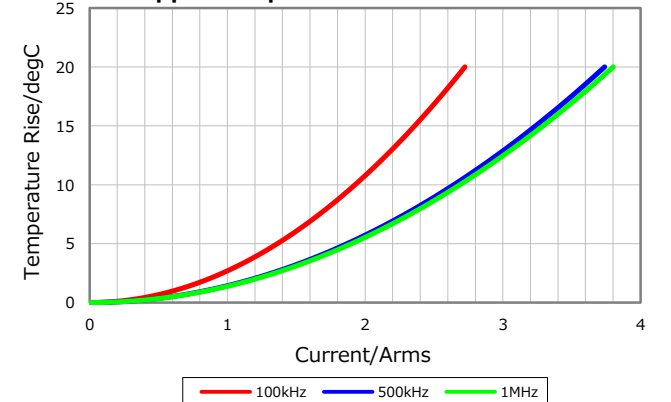

⚠ All specifications are subject to change without notice.

January 19, 2021