

# CGA4J2X7R2A104K125AE

TDK Item Description : CGA4J2X7R2A104KT\*\*\*S



Equivalent C2012X7R2A104K for Automotive

## Application & Main Feature

Automotive Grade ( Soft Termination )

## Series

CGA4(2012) [EIA CC0805]

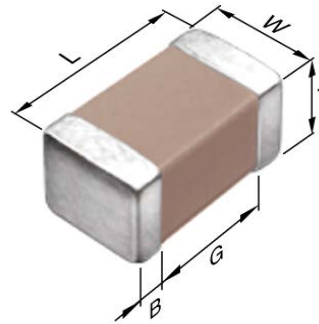

## Dimensions

L	2.00mm +0.45,-0.2mm
W	1.25mm +0.25,-0.2mm
T	1.25mm +0.25,-0.2mm
B	0.20mm Min.
G	0.50mm Min.

## Temperature Characteristic

X7R (-55 to 125 degC +/-15%)

## Rated Voltage

2A (100Vdc)

## Capacitance

100nF

## Capacitance Tolerance

K (+/-10%)

## Dissipation Factor

3% Max.

## Insulation Resistance

5Gohm Min

## AEC-Q200

Yes

## |Z|, ESR vs. Freq. Characteristics (Simulation Data)

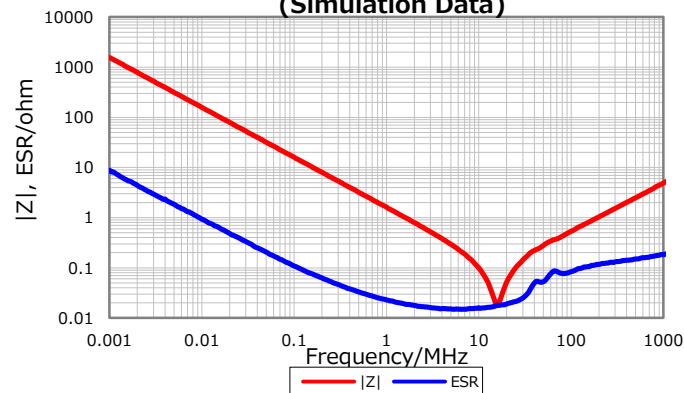

## Cap. vs. Freq. Characteristic

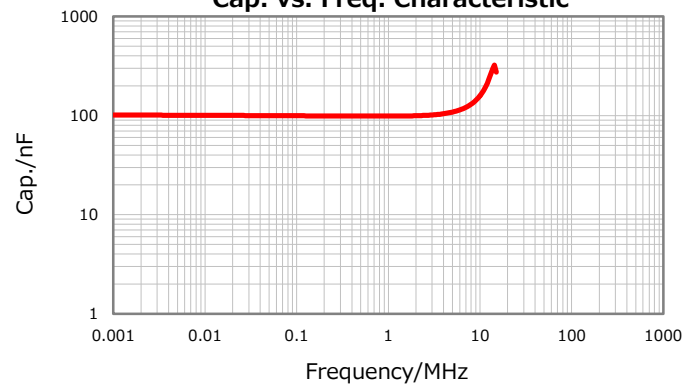

## DC Bias Characteristic

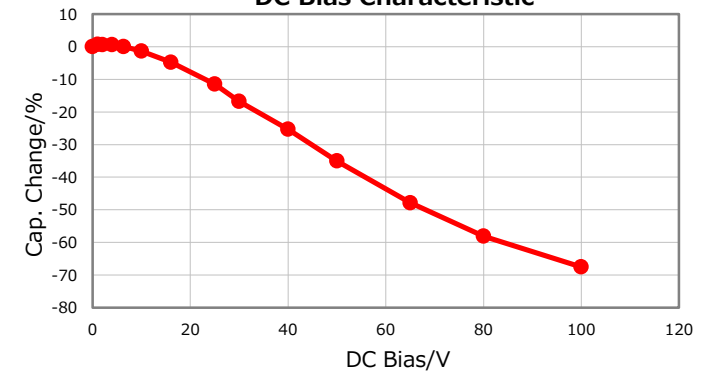

## Temperature Characteristics

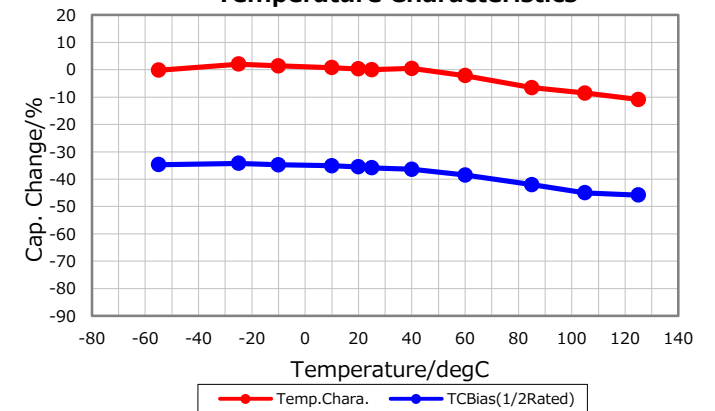

## Ripple Temperature Rise Characteristics

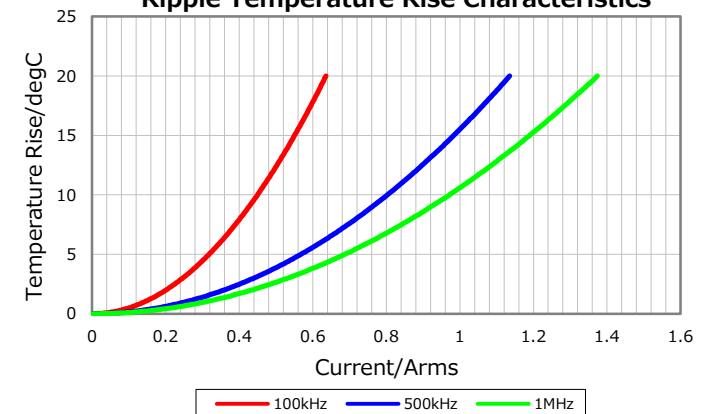

Characterization Sheet ( Multilayer Ceramic Chip Capacitors )



All specifications are subject to change without notice.

March 17, 2017