

CGA4J3X5R1C475M125AB

TDK item description : CGA4J3X5R1C475MT***



Equivalent C2012X5R1C475M for Automotive

Application & Main Feature

Automotive grade (General type)

Series

CGA4(2012) [EIA 0805]

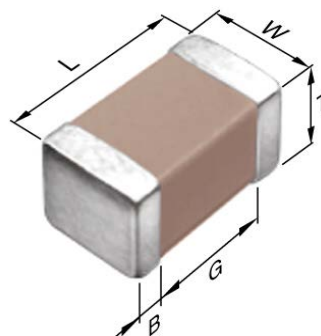

Dimensions

- L 2.00±0.20 mm
- W 1.25±0.20 mm
- T 1.25±0.20 mm
- B 0.20 mm min.
- G 0.50 mm min.

Temperature Characteristic

X5R (-55 to +85 degC, ±15%)

Rated Voltage

1C (16Vdc)

Capacitance

4.7µF

Capacitance Tolerance

M (±20%)

Dissipation Factor

7.5 % max.

Insulation Resistance

21 Mohm min.

AEC-Q200

Yes

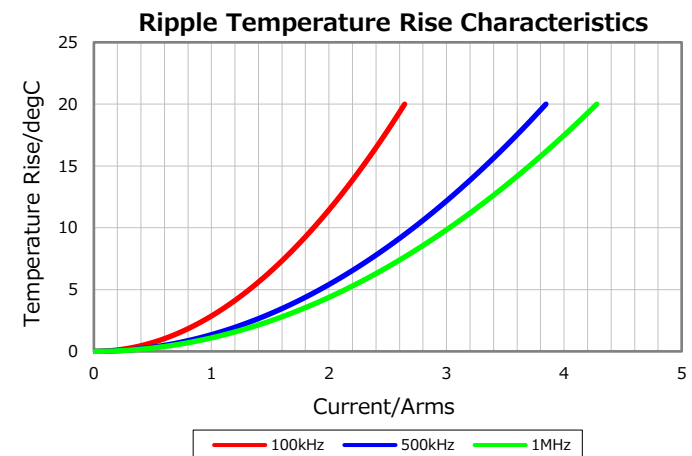
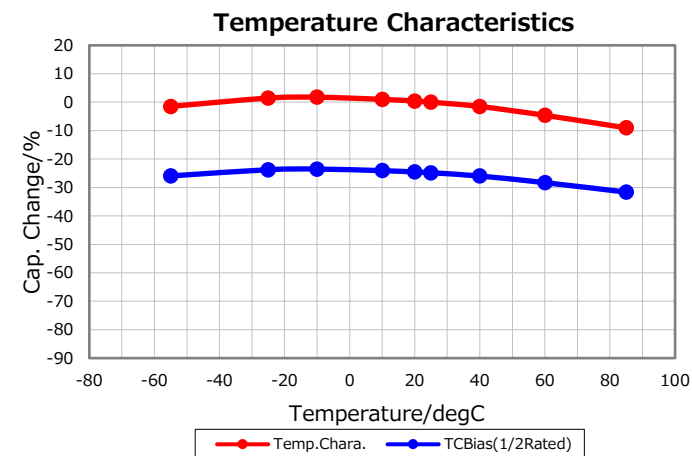
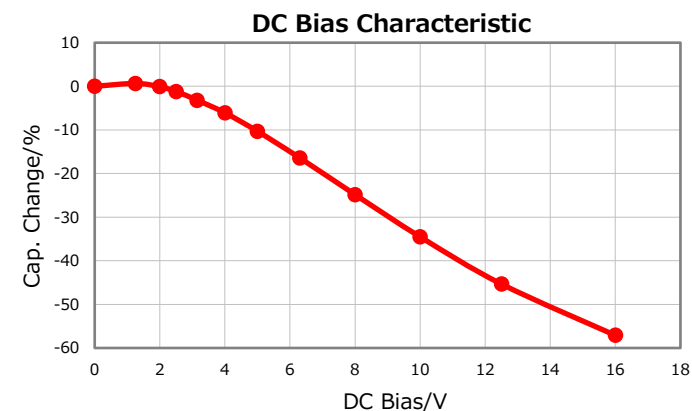
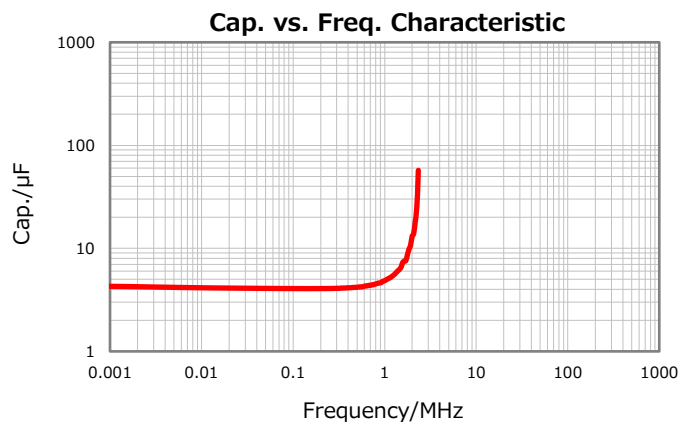
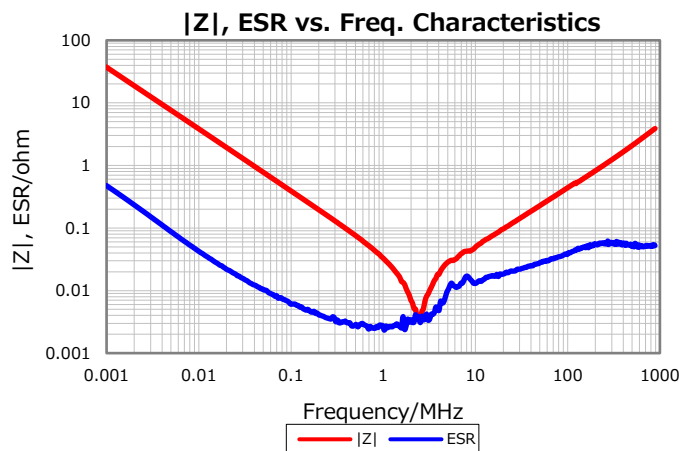

Characterization Sheet (Multilayer Ceramic Chip Capacitors)



All specifications are subject to change without notice.

February 10, 2020