

CGA5L3X7R1H225M160AB

TDK item description : CGA5L3X7R1H225MT****



Equivalent C3216X7R1H225M for Automotive

Application & Main Feature

Automotive grade (General type)

Series

CGA5(3216) [EIA 1206]

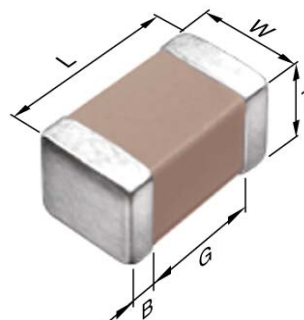

Dimensions

L	3.20+0.30/-0.10 mm
W	1.60+0.30/-0.10 mm
T	1.60+0.30/-0.10 mm
B	0.20 mm min.
G	1.00 mm min.

Temperature Characteristic

X7R (-55 to +125 degC, ±15%)

Rated Voltage

1H (50Vdc)

Capacitance

2.2µF

Capacitance Tolerance

M (±20%)

Dissipation Factor

5 % max.

Insulation Resistance

227 Mohm min.

AEC-Q200

Yes

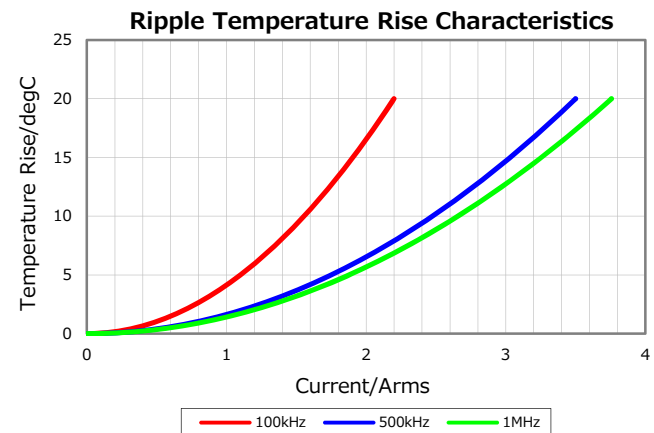
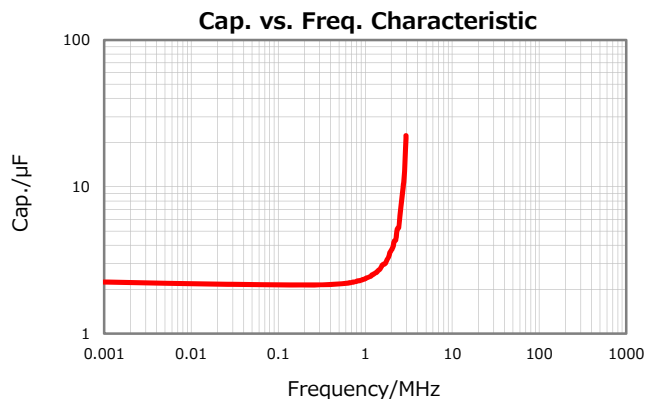
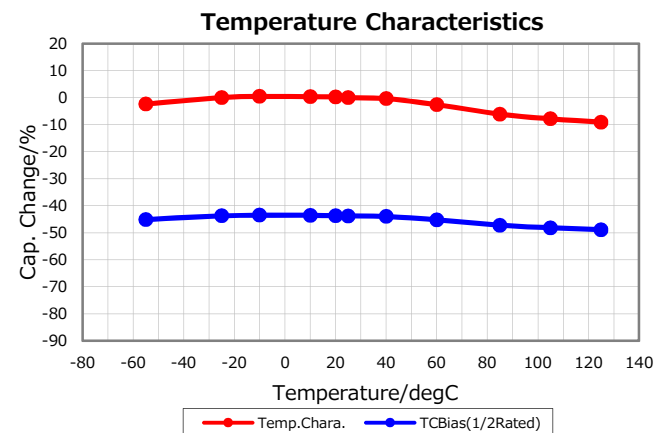
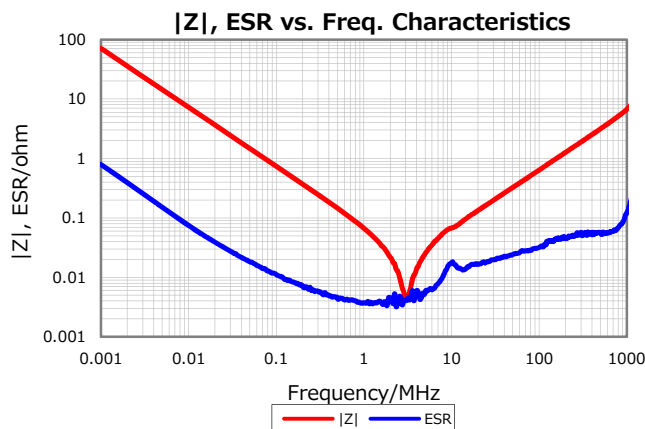
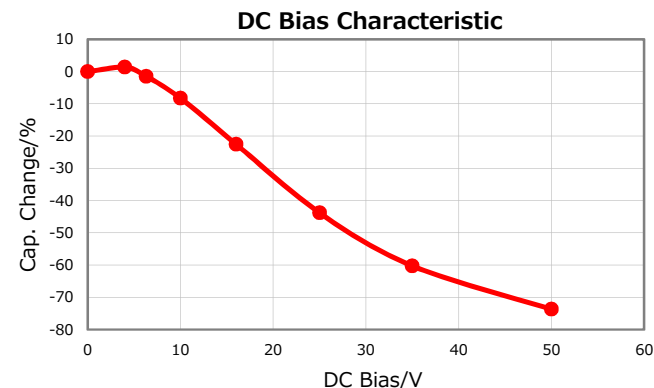

Characterization Sheet (Multilayer Ceramic Chip Capacitors)



All specifications are subject to change without notice.

January 17, 2020