

CGA6M1C0G3A472J200AE

TDK Item Description : CGA6M1C0G3A472JT***S



Equivalent C3225C0G3A472J for Automotive

Application & Main Feature

Automotive Grade (Soft Termination)

Series

CGA6(3225) [EIA 1210]

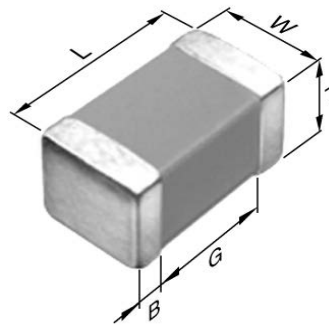

Dimensions

L	3.20mm +0.5,-0.4mm
W	2.50mm ±0.30mm
T	2.00mm +0.3,-0.2mm
B	0.20mm Min.
G	

Temperature Characteristic

C0G (-55 to 125 degC 0+/-30ppm/degC)

Rated Voltage

3A(1000Vdc)

Capacitance

4.7nF

Capacitance Tolerance

J (±5%)

Q Factor

1000 Min.

Insulation Resistance

10Gohm Min

AEC-Q200

Yes

|Z|, ESR vs. Freq. Characteristics (Simulation Data)

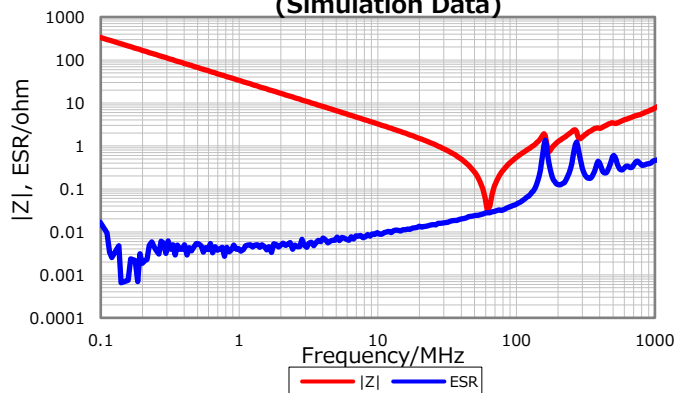

Cap. vs. Freq. Characteristic

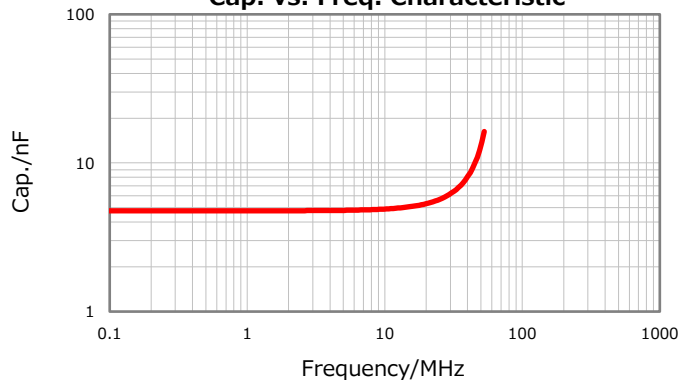

DC Bias Characteristic

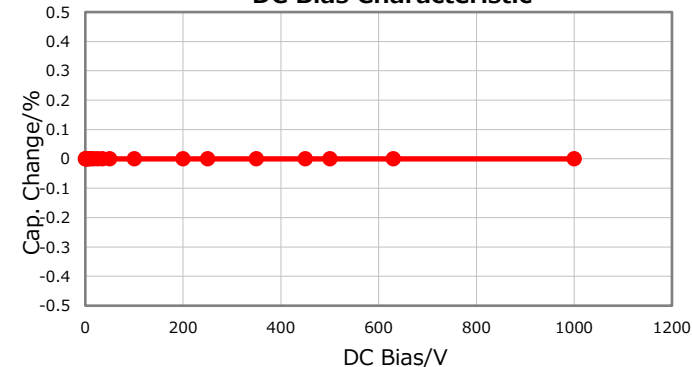

Temperature Characteristics

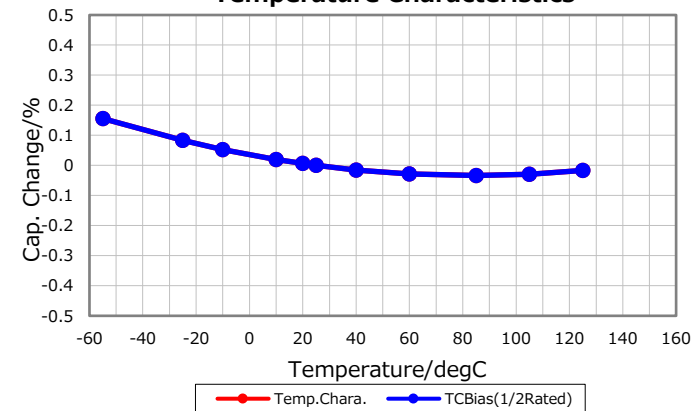

Ripple Temperature Rise Characteristics

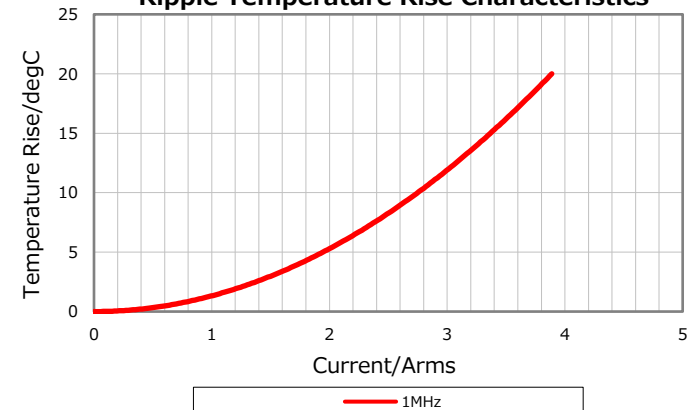

Characterization Sheet (Multilayer Ceramic Chip Capacitors)



All specifications are subject to change without notice.

June 24, 2019