

CPFE1000Fi-48

EVALUATION DATA

Tested By: Miguel Valdez / <i>M. Valdez</i>	Date : 11/11/2015
---------------------------------------------	-------------------

Name/Signature

Checked By: Kenneth Rose / <i>KC Rose</i>	Date : 11/11/2015
-------------------------------------------	-------------------

Name/Signature

Approved By: Greg Laufman / <i>Greg Laufman</i>	Date: 11/12/2015
-------------------------------------------------	------------------

Name/Signature

INDEX

1. Test Set-ups

2. Characteristics

- 2.1 Line and Load regulation
- 2.2 Input turn ON/OFF voltage characteristics.
- 2.3 Efficiency and Power factor vs. Output power and Input Voltage, Standby Input Power
- 2.4 Over current protection (OCP) characteristics.
- 2.5 Over voltage protection (OVP) characteristics.
- 2.6 Output rise and fall characteristics
- 2.7 Output rise and fall characteristics with ON/OFF control.
- 2.8 Hold up time characteristics
- 2.9 Dynamic line response characteristics
- 2.10 Dynamic load response characteristics
- 2.11 Response to brownout characteristics
- 2.12 Inrush current characteristics
- 2.13 Input current waveforms
- 2.14 Input current harmonics
- 2.15 Leakage current characteristics
- 2.16 Output ripple and noise waveforms

Test Equipment used:

Digital Multi-Meter (DMM) - Model: Fluke 45
Power Source - Model: Kikusui DCR4000L
Electronic Load - Model: Chroma 63201
Digital Power Meter - Model: Yokogawa WT2010
Digital Power Meter - Model: Chroma 66202
Oscilloscope - Model: Tektronix DPO2024
Leakage Tester - Associate Research Model no. 620L

Terminology used

Vin	Input Voltage	Io.....	Output Current
Vout.....	Output Voltage	Tbp.....	Base Plate Temperature
+ON.....	Control Voltage	Ta.....	Ambient Temperature
Iin.....	Input Current	f.....	Frequency
Pin.....	Input Power	Eff.....	Efficiency
Po.....	Ouptut Power	PF.....	Power factor

1. Test set-ups

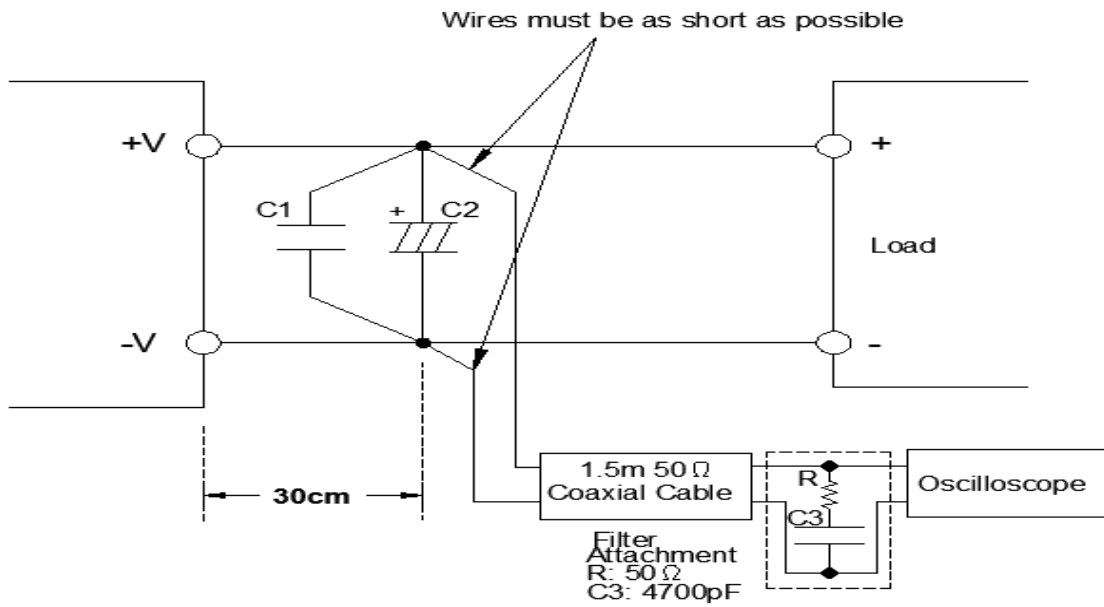
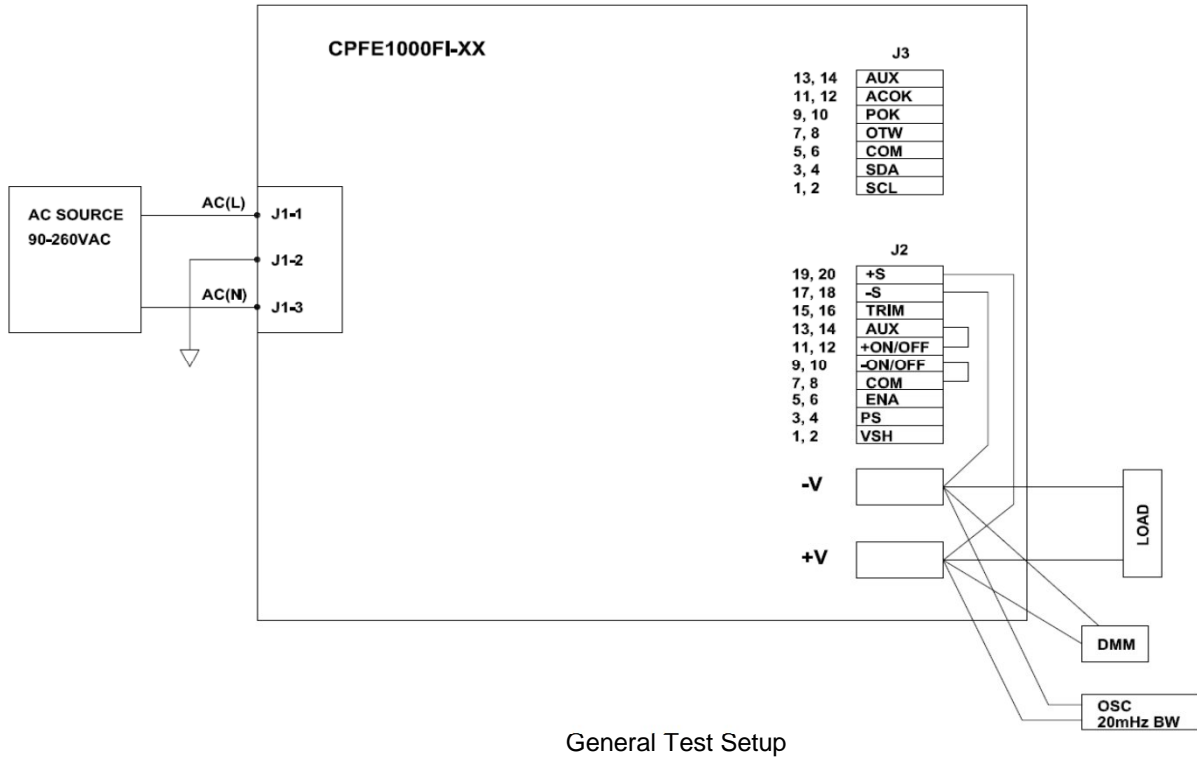

C1 - 0.1 μ F Ceramic Capacitor

C2 - 47 μ F Aluminum Electrolytic Capacitor

Setup for Ripple Measurement

2. Characteristics

2.1 Line and Load Regulation:

Condition Tbp = 25°C

Vout measured across output studs using **local sense** connections.

Io \ Vin	90 VAC	110 VAC	220 VAC	265 VAC	Line Regulation	
0% Load	48.001	48.003	48.007	48.010	0.009	0.019%
25% Load	48.017	48.014	48.011	48.008	0.009	0.019%
50% Load	48.019	48.020	48.023	48.026	0.007	0.015%
75% Load	48.027	48.027	48.028	48.028	0.001	0.002%
100% Load	48.022	48.022	48.021	48.019	0.003	0.006%
Load Regulation	0.026	0.024	0.021	0.02		
	0.054%	0.050%	0.044%	0.042%		

Vout measured across output studs using **remote sense** connections.

Io \ Vin	90 VAC	110 VAC	220 VAC	265 VAC	Line Regulation	
0% Load	47.917	47.915	47.913	47.911	0.006	0.013%
25% Load	47.923	47.925	47.925	47.926	0.003	0.006%
50% Load	47.944	47.945	47.946	47.947	0.003	0.006%
75% Load	47.978	47.974	47.970	47.968	0.01	0.021%
100% Load	48.000	48.003	48.007	48.010	0.01	0.021%
Load Regulation	0.083	0.088	0.094	0.099		
	0.173%	0.183%	0.196%	0.206%		

2.2 Input turn ON/OFF voltage characteristics.

Condition Tbp = 25°C

	0% Load	100%Load
Turn ON Voltage	76	75
Turn OFF Voltage	69	71

2.3 Efficiency and Power factor vs. Output power and Input Voltage, Standby Input Power

Condition Tbp = 25°C

Vin	Iin	Pin	PF	Vout	Io	Po	Eff	Load
90 VAC	0.632	48.3	0.849	47.982	0.0	0	N/A	0%
110 VAC	0.527	47.5	0.82	47.992	0.0	0	N/A	
220 VAC	0.493	45.2	0.416	48.004	0.0	0	N/A	
265 VAC	0.632	44.1	0.268	48.012	0.0	0	N/A	
90 VAC	3.946	334.6	0.947	47.97	5.25	251.8425	75.27%	25%
110 VAC	3.218	331.7	0.94	47.969	5.25	251.8373	75.92%	
220 VAC	1.641	316.7	0.884	47.969	5.25	251.8373	79.52%	
265 VAC	1.471	312.2	0.814	47.965	5.25	251.8163	80.66%	
90 VAC	7.148	614.3	0.950	47.964	10.50	503.622	81.98%	50%
110 VAC	5.837	608.3	0.952	47.967	10.50	503.6535	82.80%	
220 VAC	2.845	584.4	0.932	47.970	10.50	503.685	86.19%	
265 VAC	2.492	576.3	0.884	47.973	10.50	503.7165	87.41%	
90 VAC	10.617	903.1	0.958	47.986	15.75	755.7795	83.69%	75%
110 VAC	8.561	894.5	0.957	47.982	15.75	755.7165	84.48%	
220 VAC	4.139	863.2	0.947	47.977	15.75	755.6378	87.54%	
265 VAC	3.561	851.1	0.914	47.972	15.75	755.559	88.77%	
90 VAC	14.210	1216.5	0.969	47.990	21.0	1007.79	82.84%	100%
110 VAC	11.457	1198.2	0.962	47.999	21.0	1007.979	84.12%	
220 VAC	5.499	1154.0	0.954	48.007	21.0	1008.147	87.36%	
265 VAC	4.703	1139.6	0.931	48.013	21.0	1008.273	88.48%	

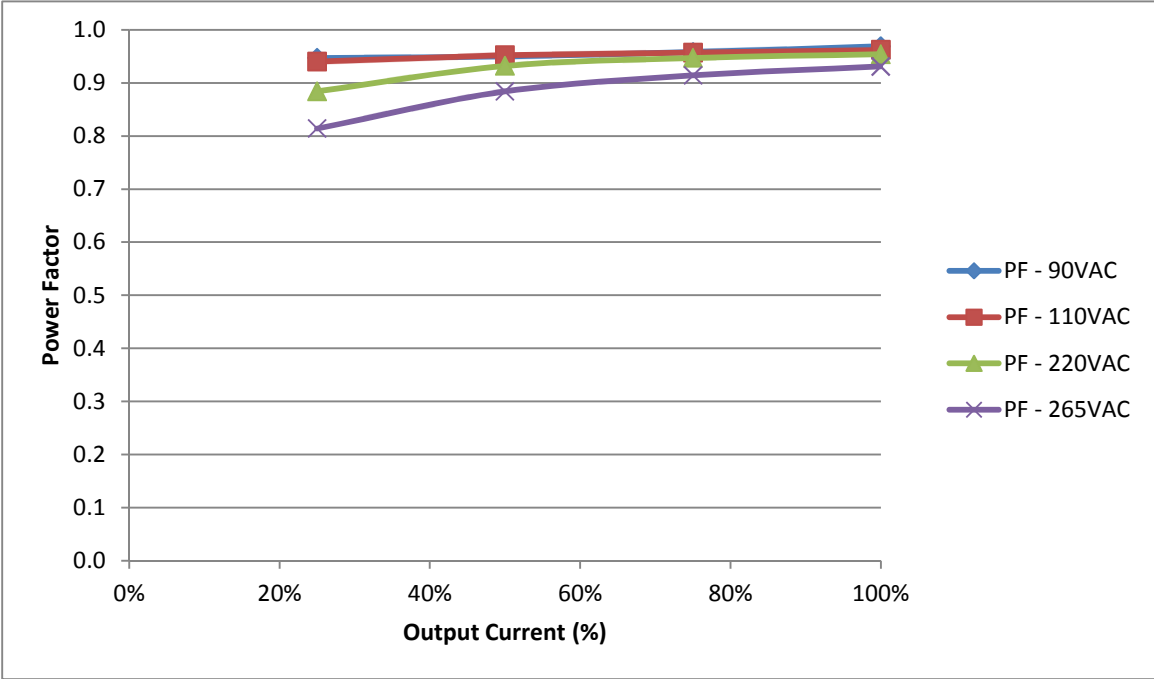
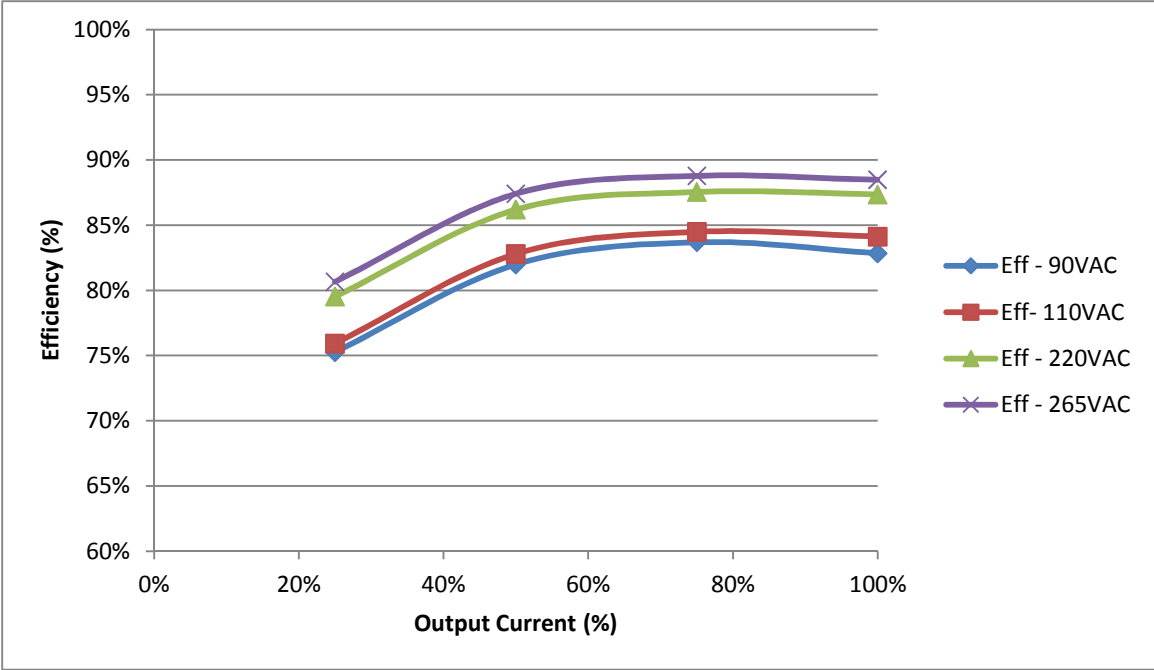

2.4 Over current protection (OCP) characteristics.

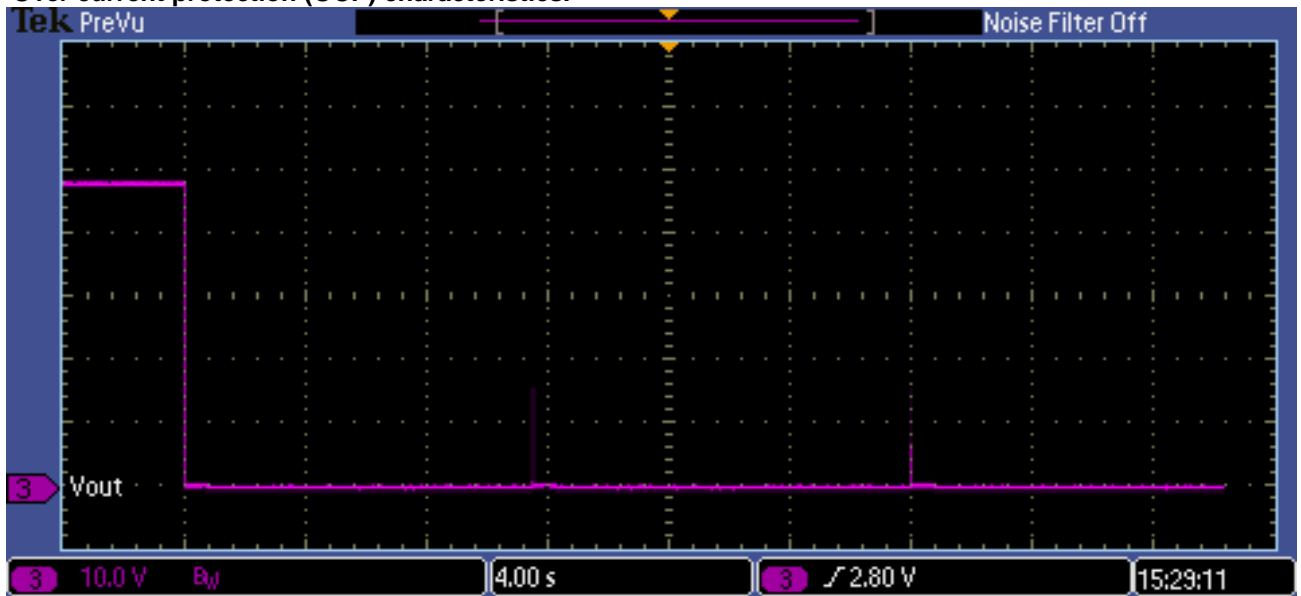

Vout: 10V/div
4s/div
Output Voltage during OCP mode.

2.5 Over voltage protection (OVP) characteristics.

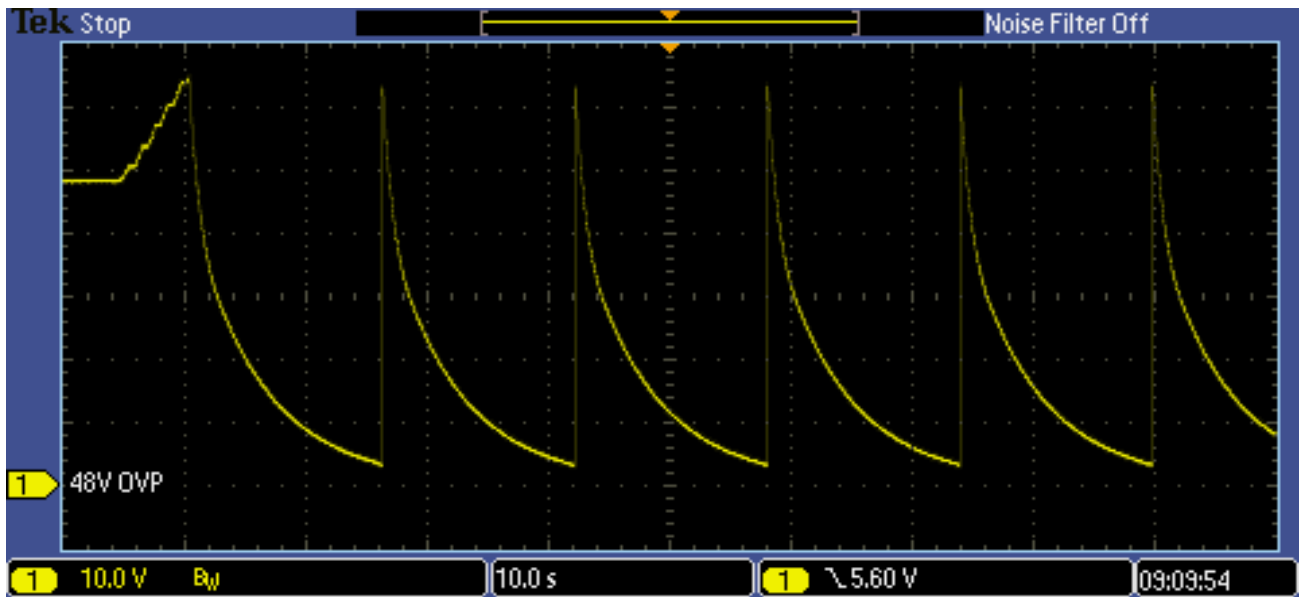

Vout: 10V/div 10s/div
Output Voltage during OVP mode (0% Load)

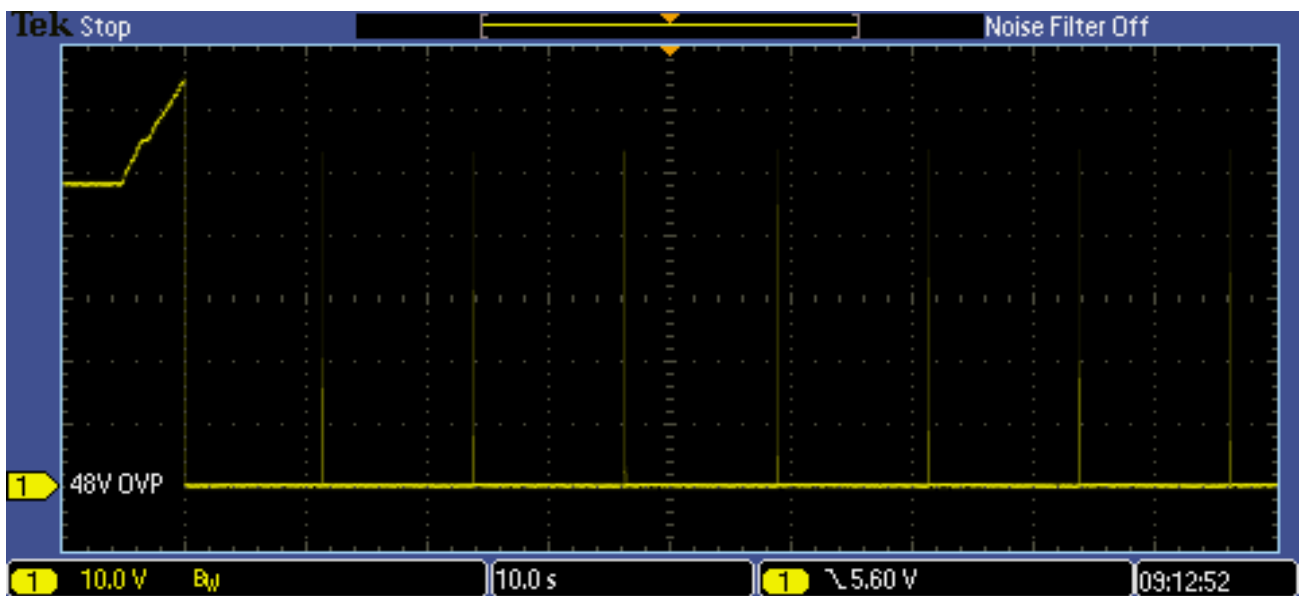

Vout: 10V/div 10s/div
Output Voltage during OVP mode (100% Load)

2.6 Output rise and fall characteristics

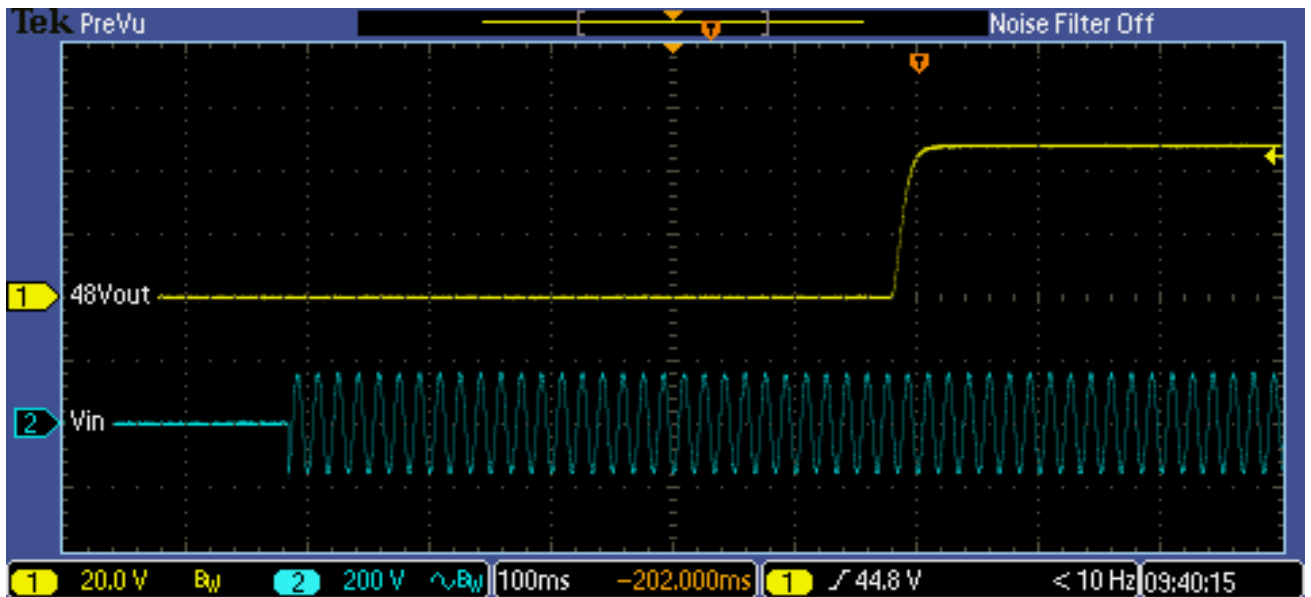

Vin: 200V/div Vout: 20V/div 100ms/div
Output rise (0% Load, 110Vac input)

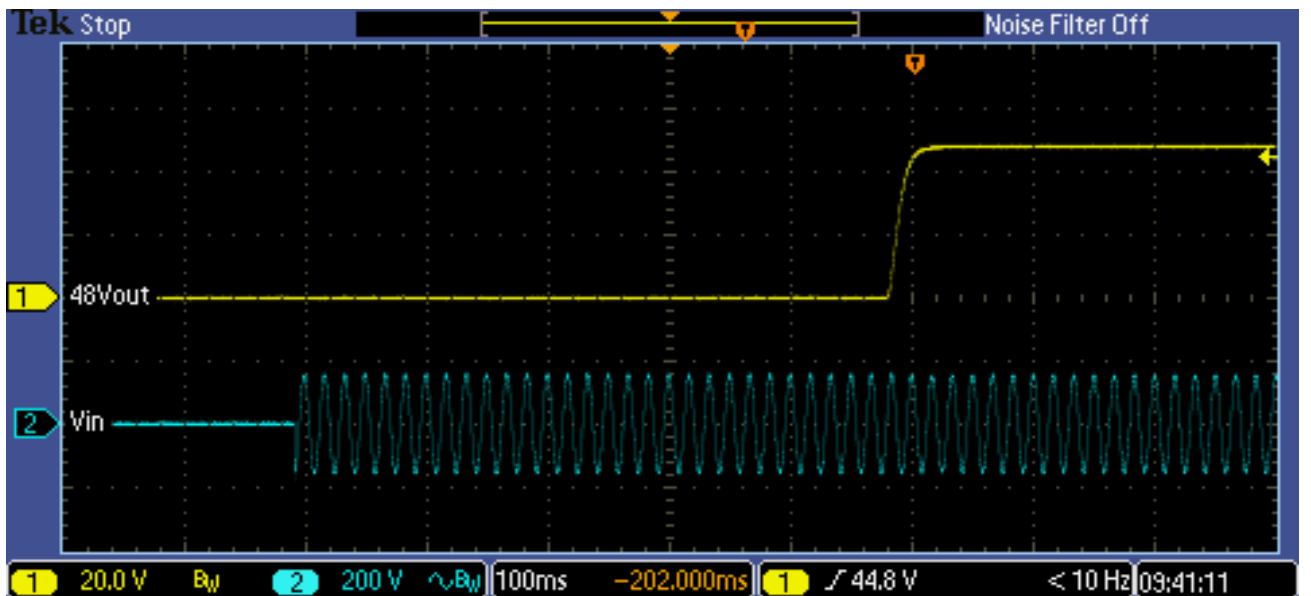

Vin: 200V/div Vout: 20V/div 100ms/div
Output rise (100% Load, 110Vac input)

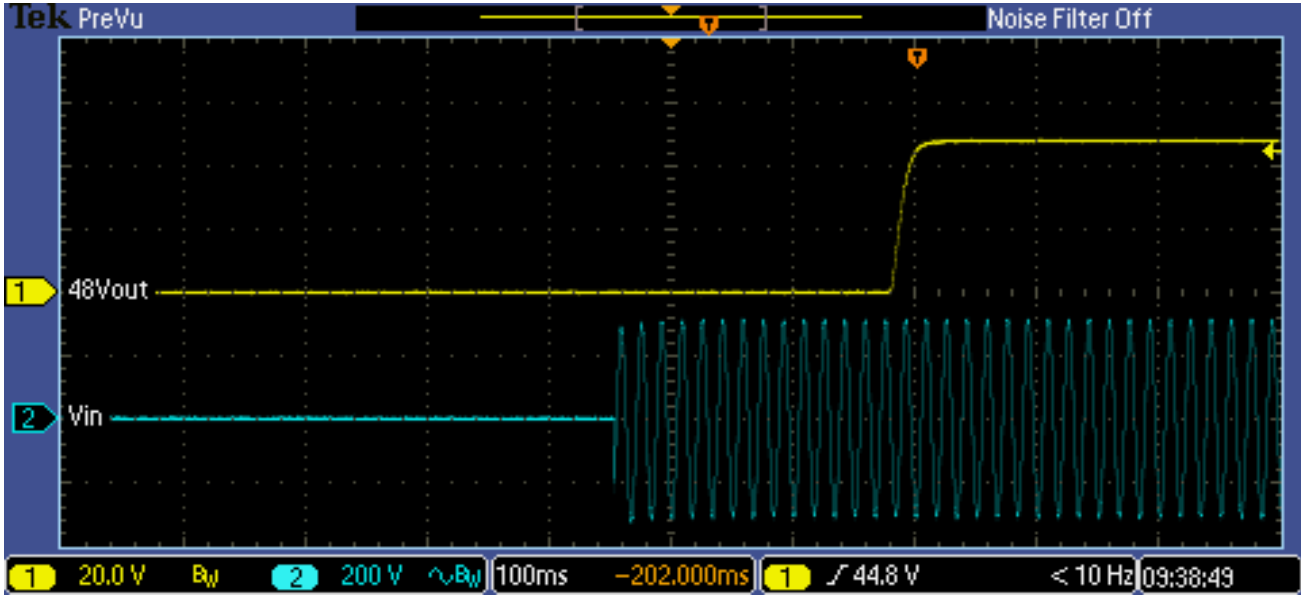

Vin: 200V/div Vout: 20V/div 100ms/div
Output rise (0% Load, 220Vac input)

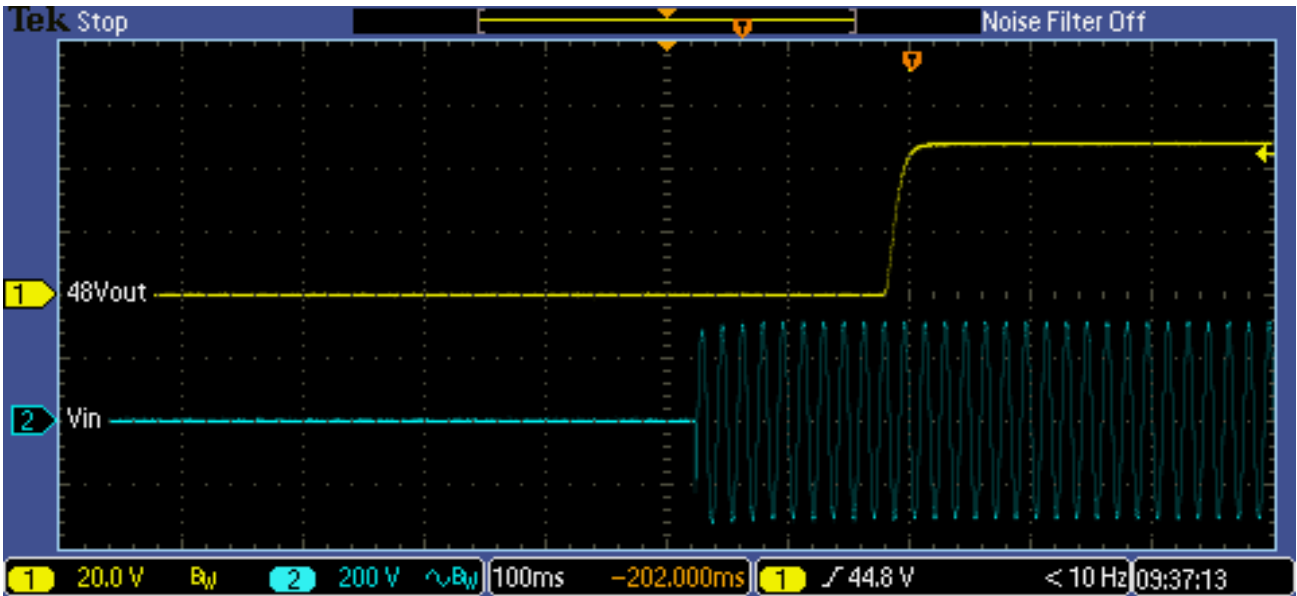

Vin: 200V/div Vout: 20V/div 100ms/div
Output rise (100% Load, 220Vac input)

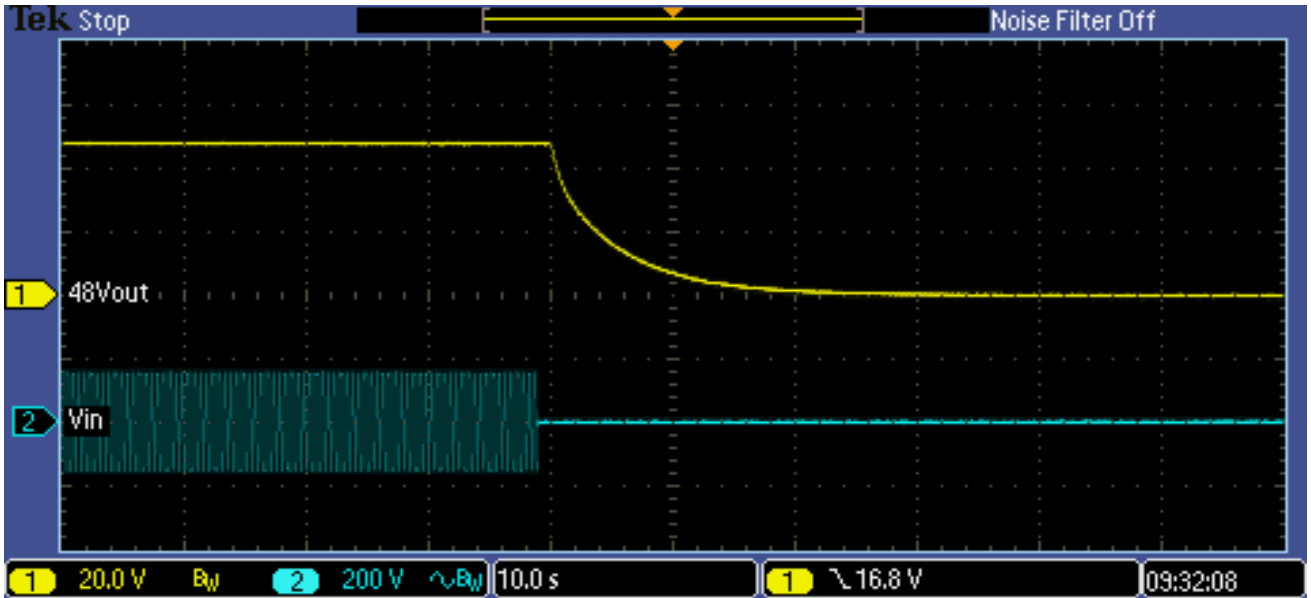

Vin: 200V/div Vout: 20V/div 10s/div
 Output fall (0% Load, 110Vac input)

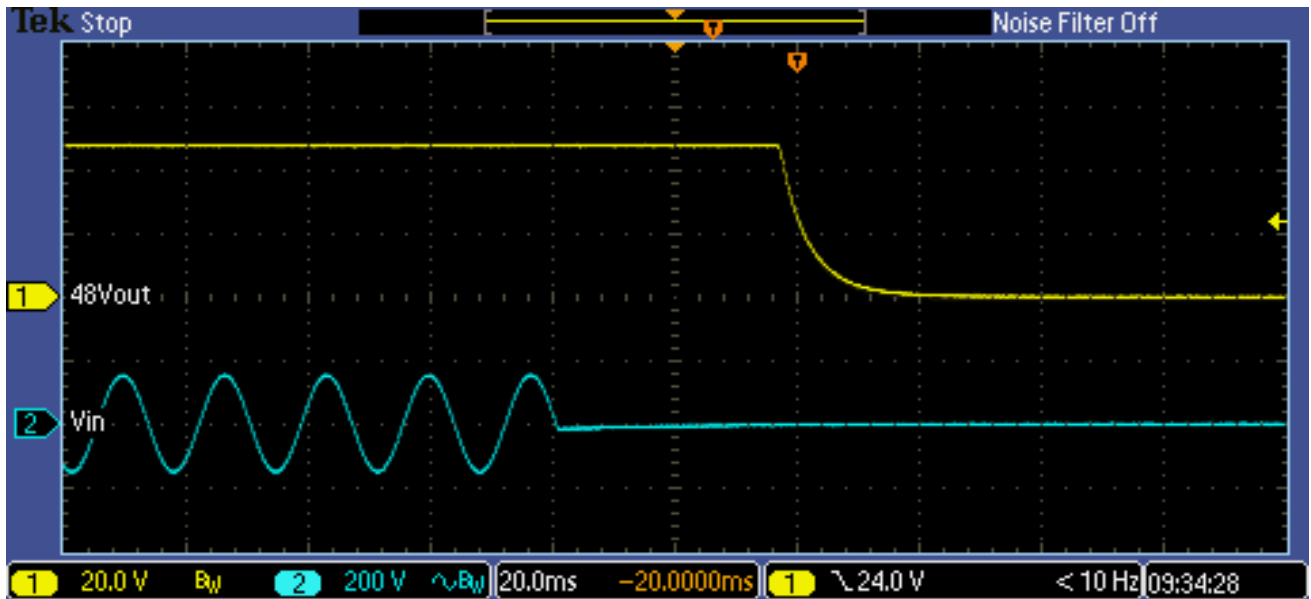

Vin: 100V/div Vout: 20V/div 20ms/div
 Output fall (100% Load, 110Vac input)

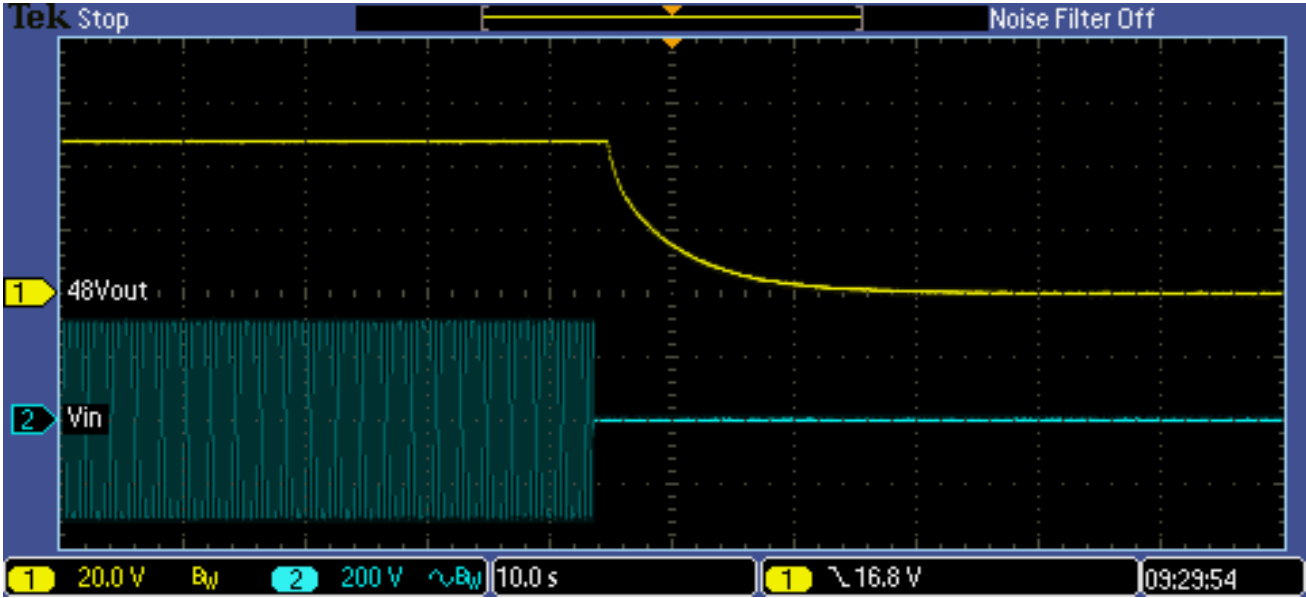

Vin: 200V/div Vout: 20V/div 10s/div
 Output fall (0% Load, 220Vac input)

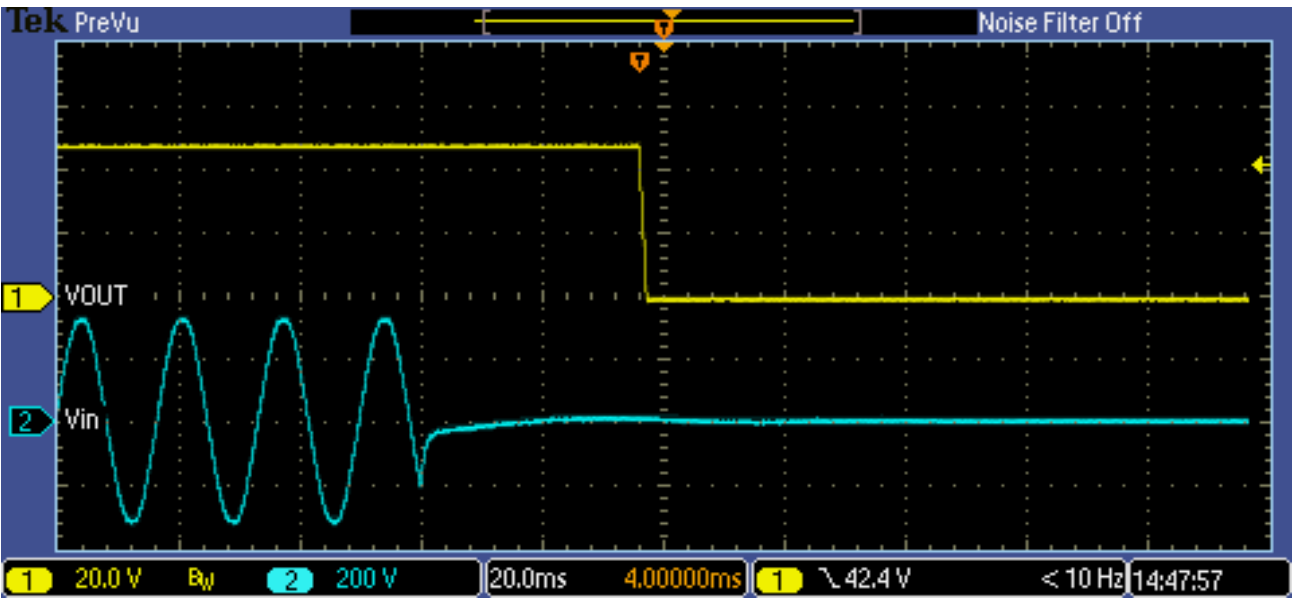

Vin: 200V/div Vout: 20V/div 20ms/div
 Output fall (100% Load, 220Vac input)

2.7 Output rise and fall characteristics with ON/OFF control.

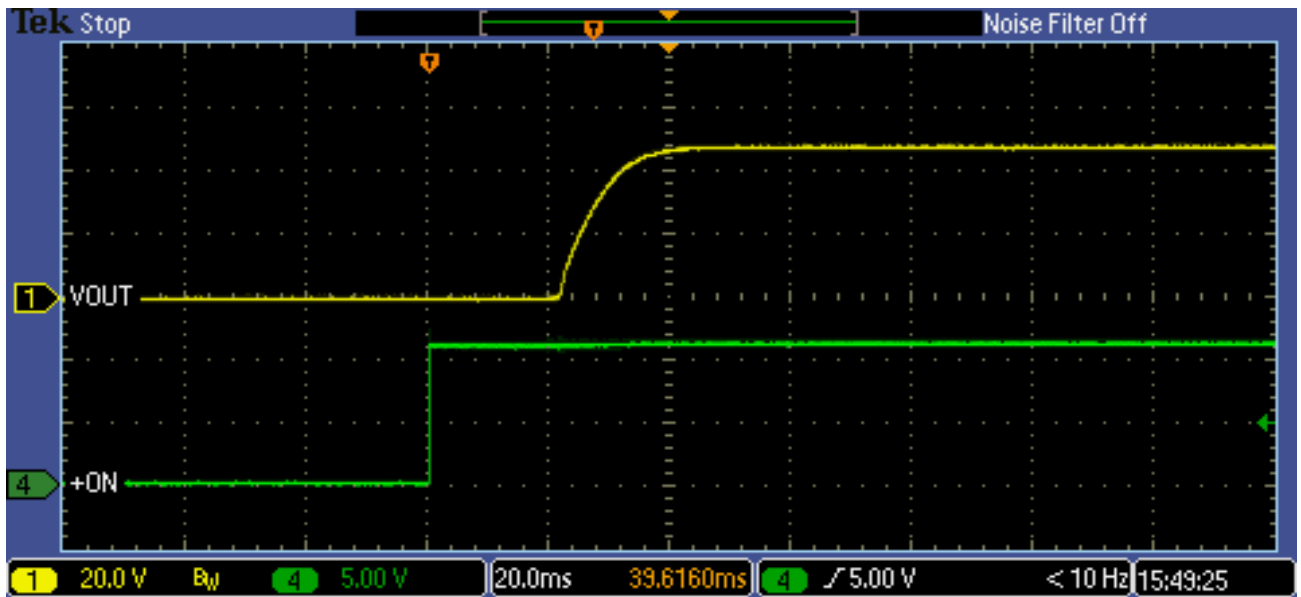

+ON: 5V/div Vout: 20V/div 20ms/div
Output rise with ON/OFF control(0% Load, 110Vac input)

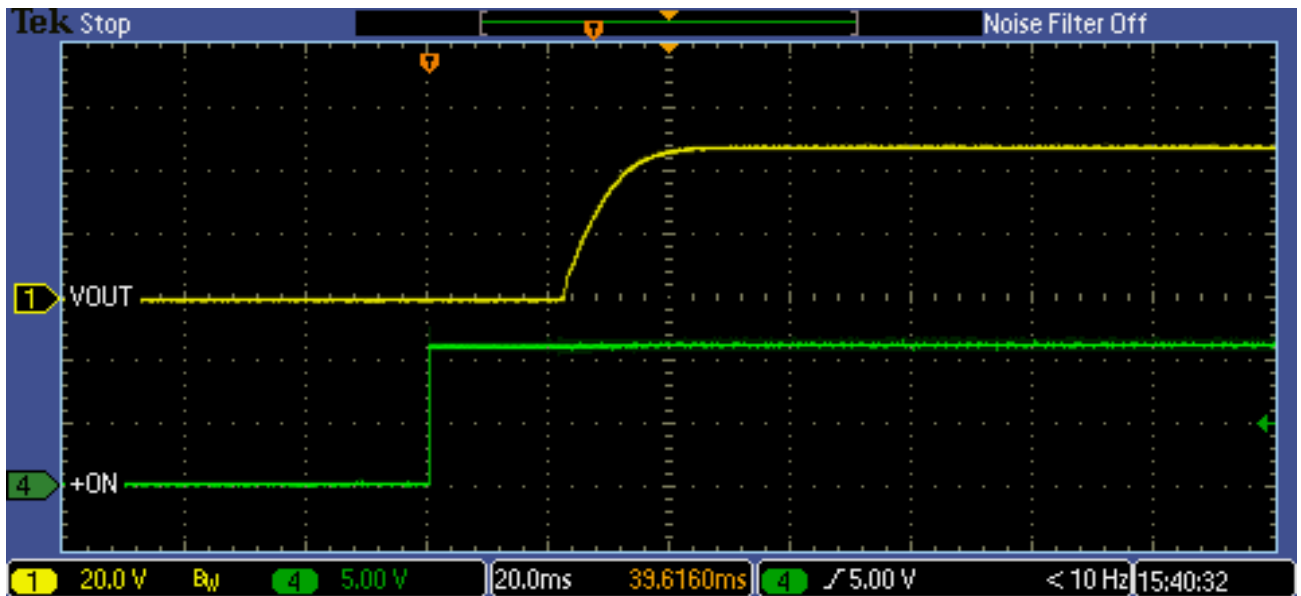

+ON: 5V/div Vout: 20V/div 20ms/div
Output rise with ON/OFF control(100% Load, 110Vac input)

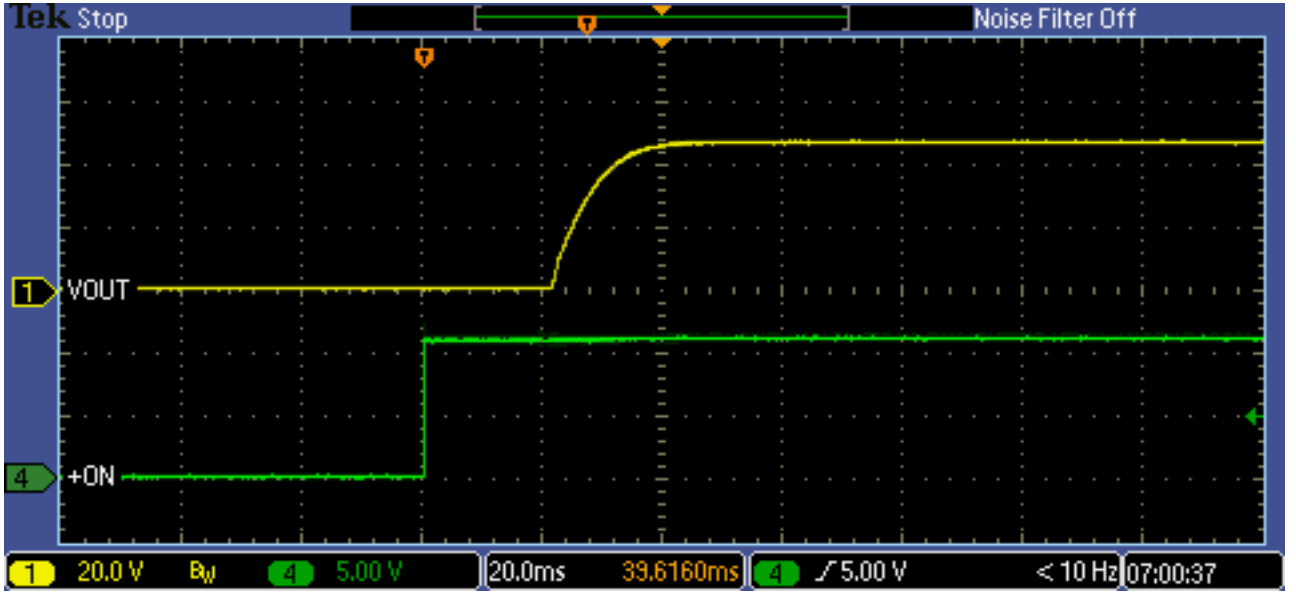

+ON: 5V/div Vout: 20V/div 20ms/div
 Output rise with ON/OFF control(0% Load, 220Vac input)

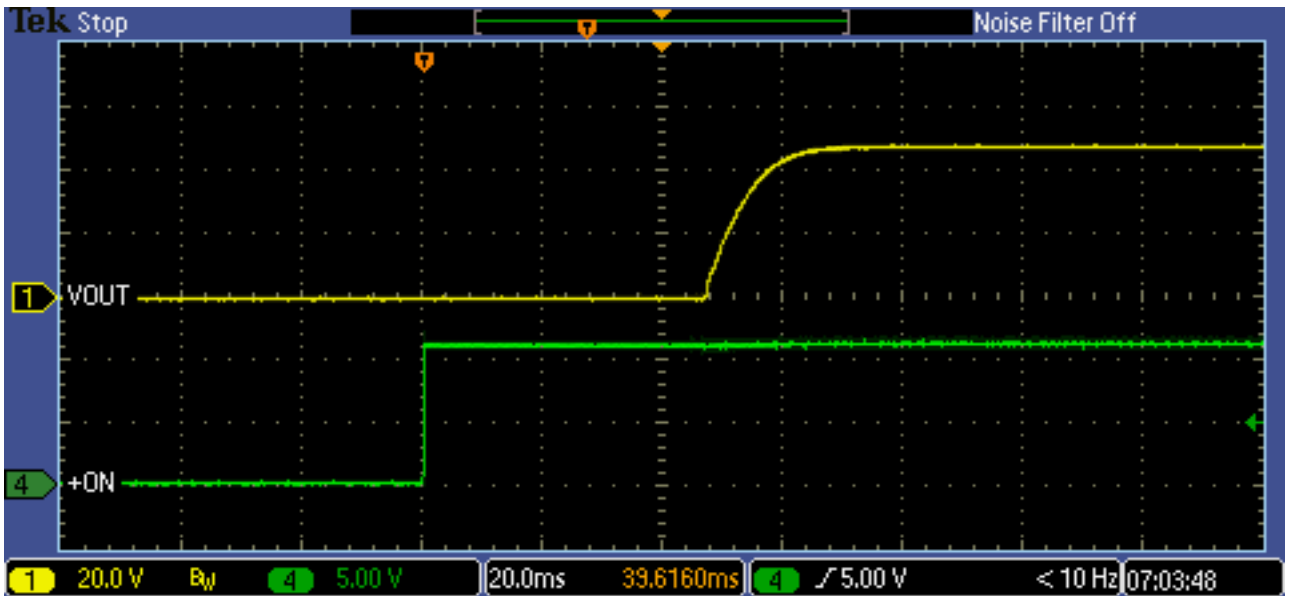

+ON: 5V/div Vout: 20V/div 20ms/div
 Output rise with ON/OFF control(100% Load, 220Vac input)

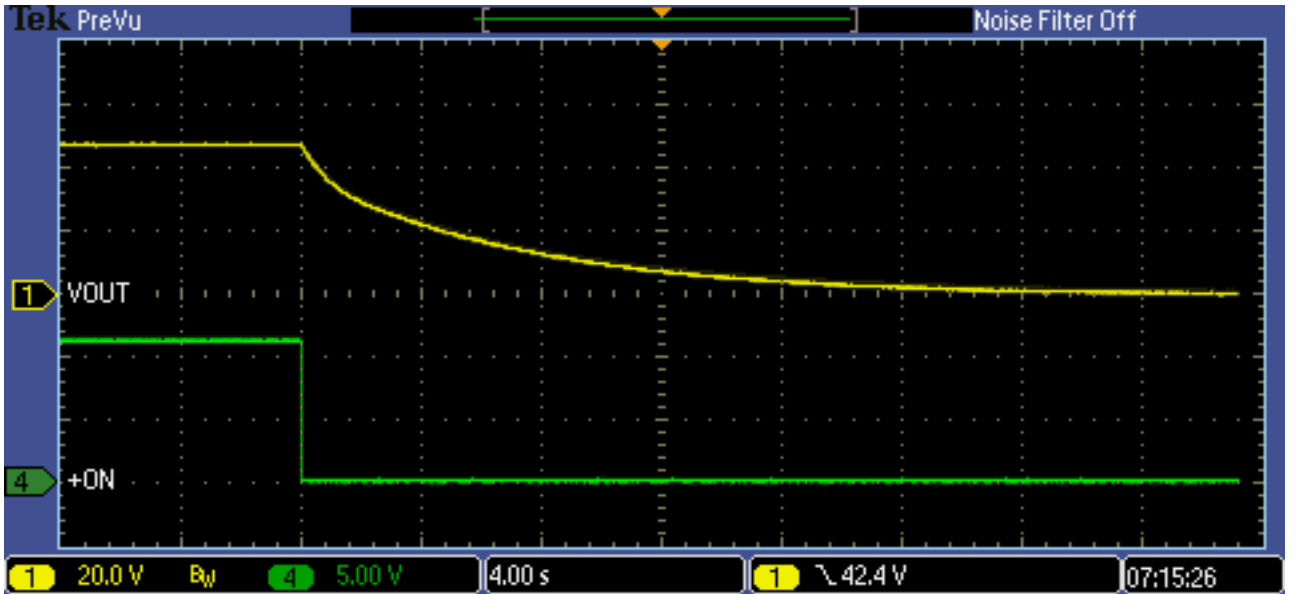

+ON: 5V/div Vout: 20V/div 4s/div
 Output fall with ON/OFF control(0% Load, 110Vac input)

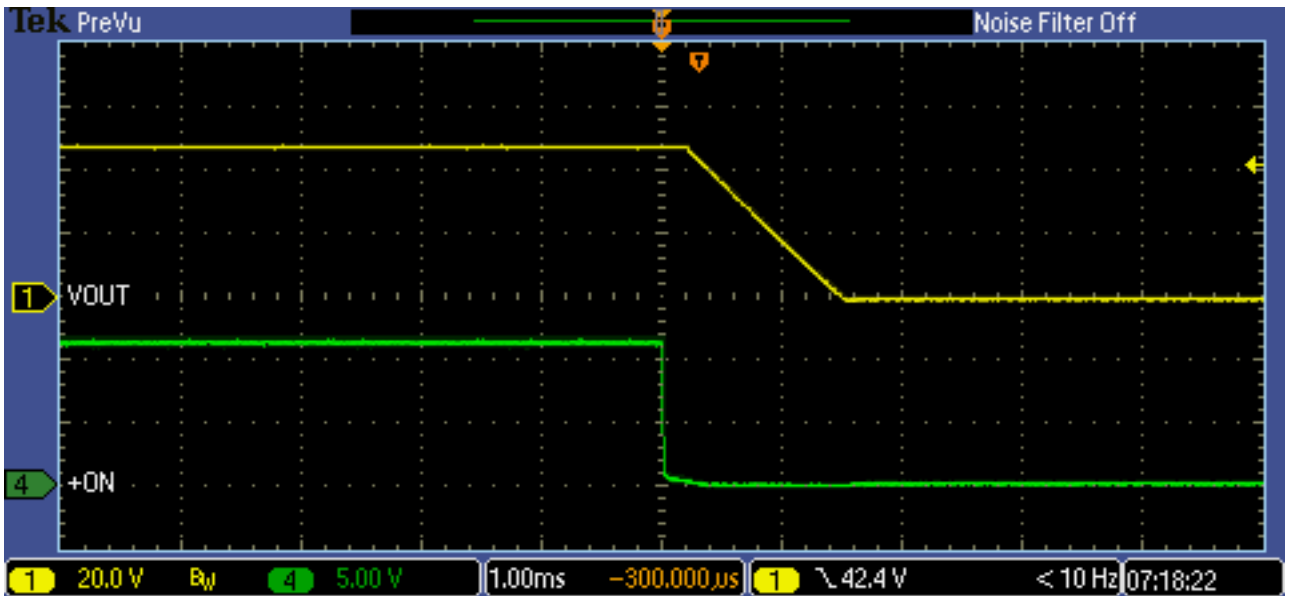

+ON: 5V/div Vout: 20V/div 1ms/div
 Output fall with ON/OFF control(100% Load, 110Vac input)



+ON: 5V/div Vout: 20V/div 4s/div
 Output fall with ON/OFF control(0% Load, 220Vac input)

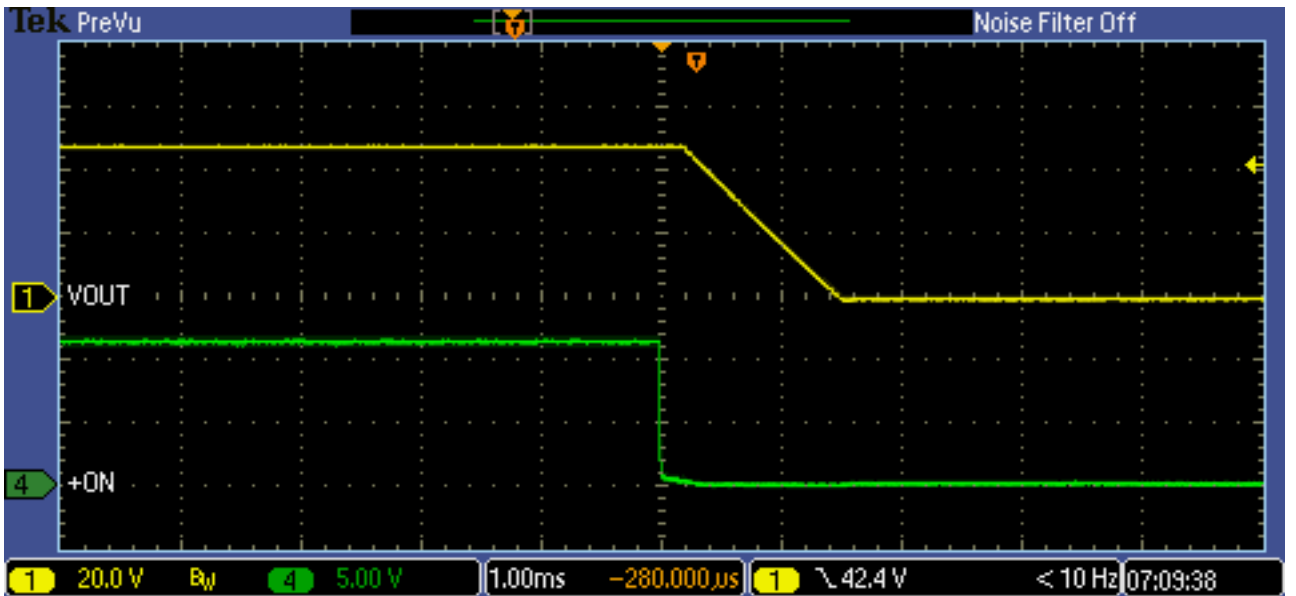

+ON: 5V/div Vout: 20V/div 1ms/div
 Output fall with ON/OFF control(100% Load, 220Vac input)

2.8 Hold up time characteristics

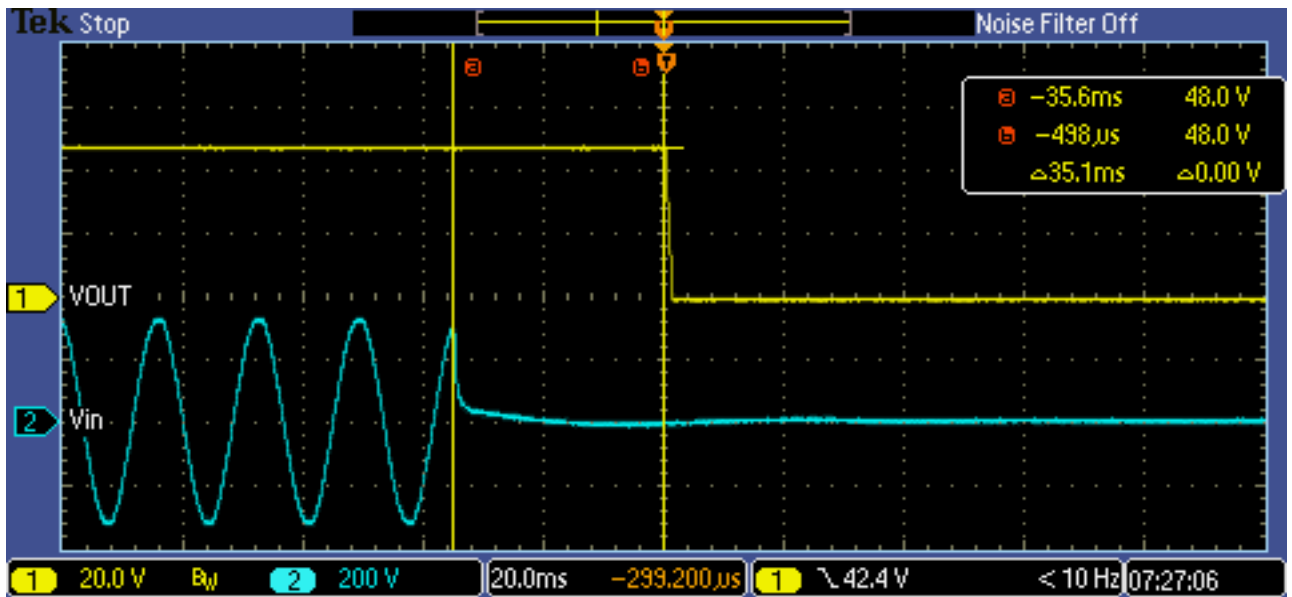

Vin: 200V/div Vout: 5V/div 20ms/div
Output fall with ON/OFF control(100% Load, 220Vac input)

Load (%)	Hold up time (ms)
20	153
40	84
60	56
80	42
100	35

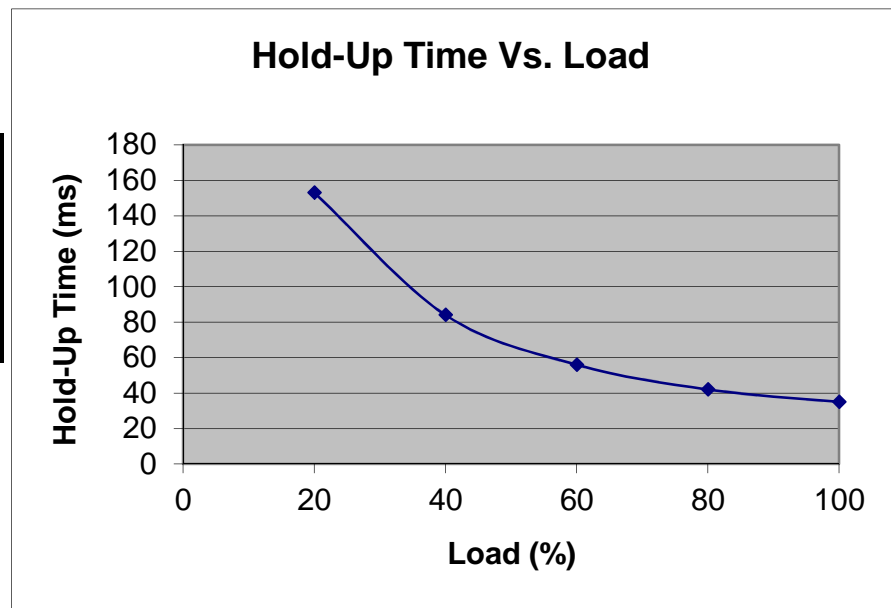

2.9 Dynamic line response characteristics



Vin: 100V/div Vout: 20V/div 200ms/div
Vin: 90VAC \iff 135VAC (100% Load)

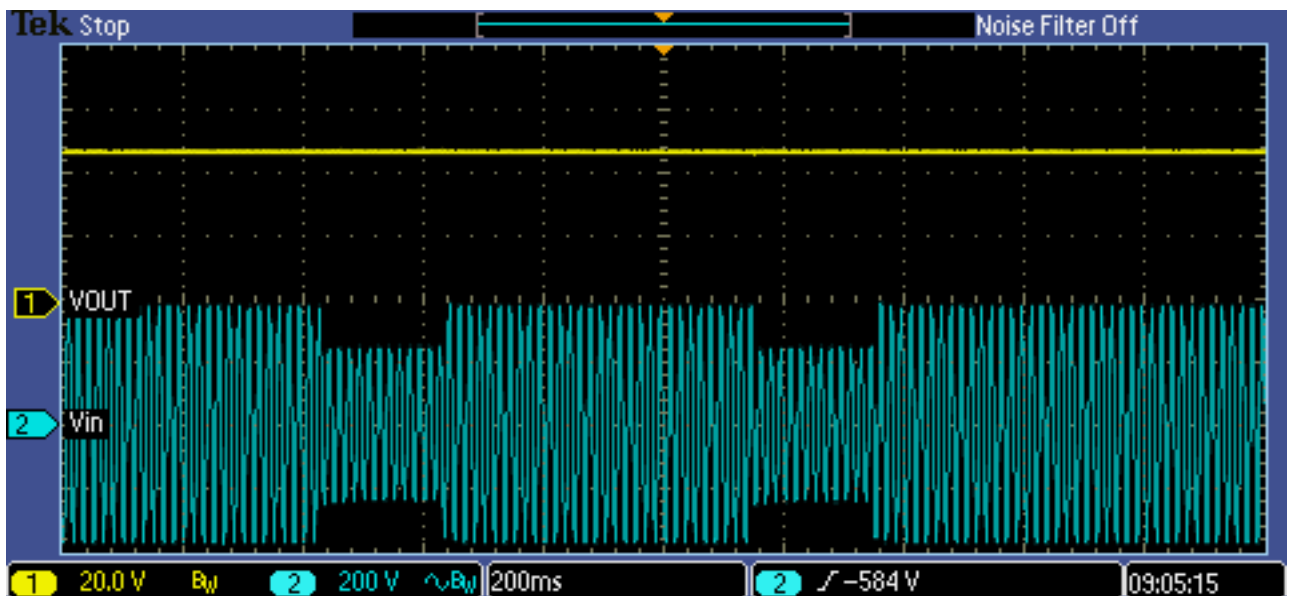

Vin: 200V/div Vout: 20V/div 200ms/div
Vin: 170VAC \iff 265VAC (100% Load)

2.10 Dynamic load response characteristics

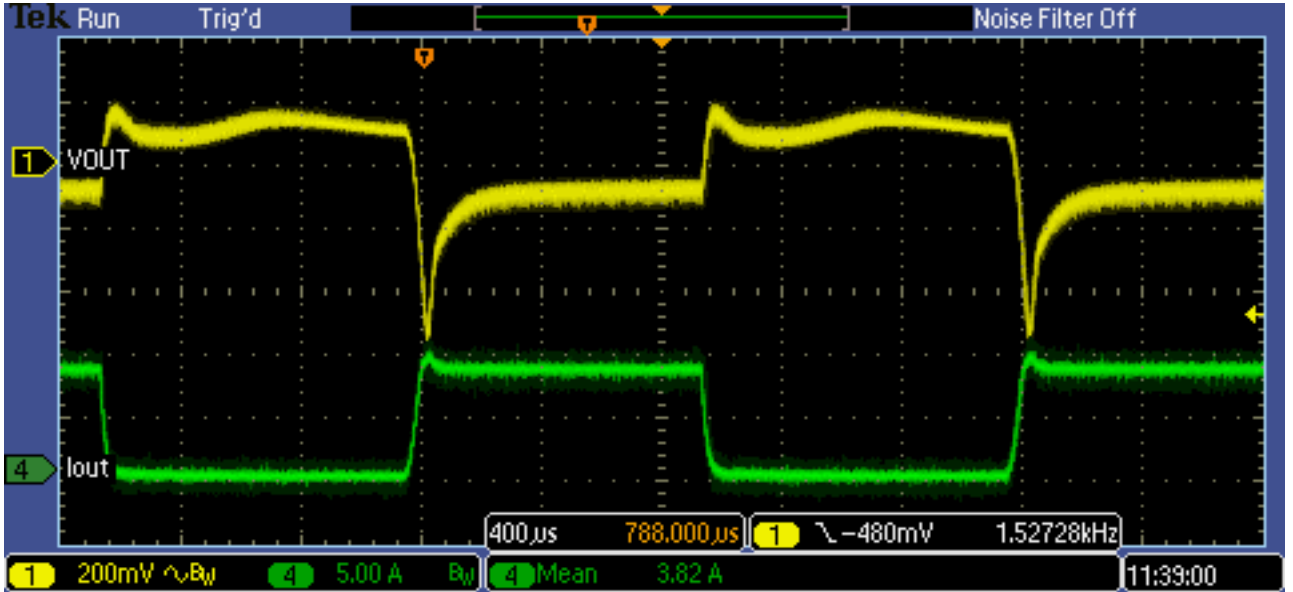

Iout: 5A/div Vout: 200mV/div 400us/div
 Dynamic Load Response (0% to 50% Load, 110Vac input)

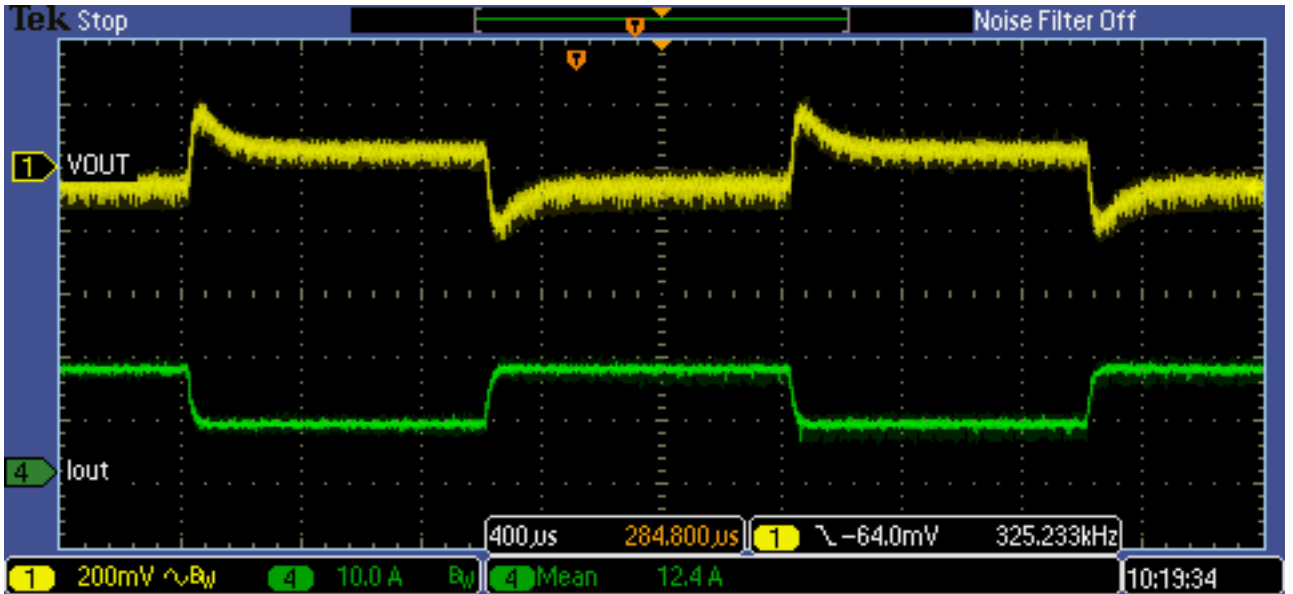

Iout: 10A/div Vout: 200mV/div 400us/div
 Dynamic Load Response (50% to 100% Load, 110Vac input)

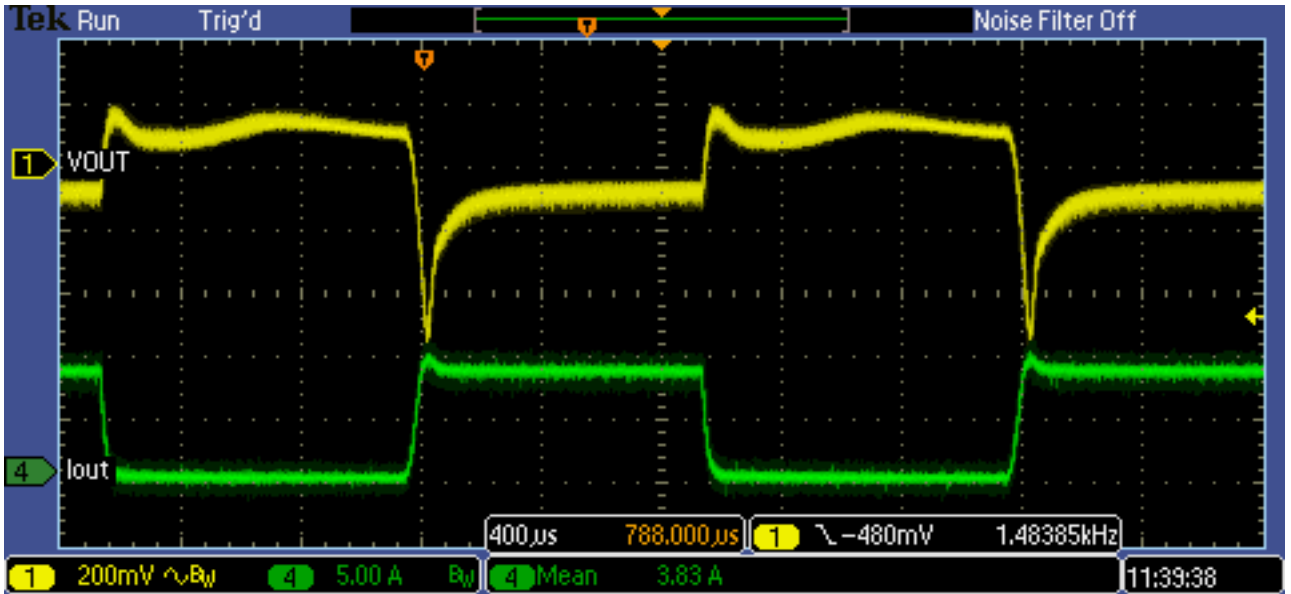

Iout: 5A/div Vout: 200mV/div 400us/div
 Dynamic Load Response (0% to 50% Load, 220Vac input)

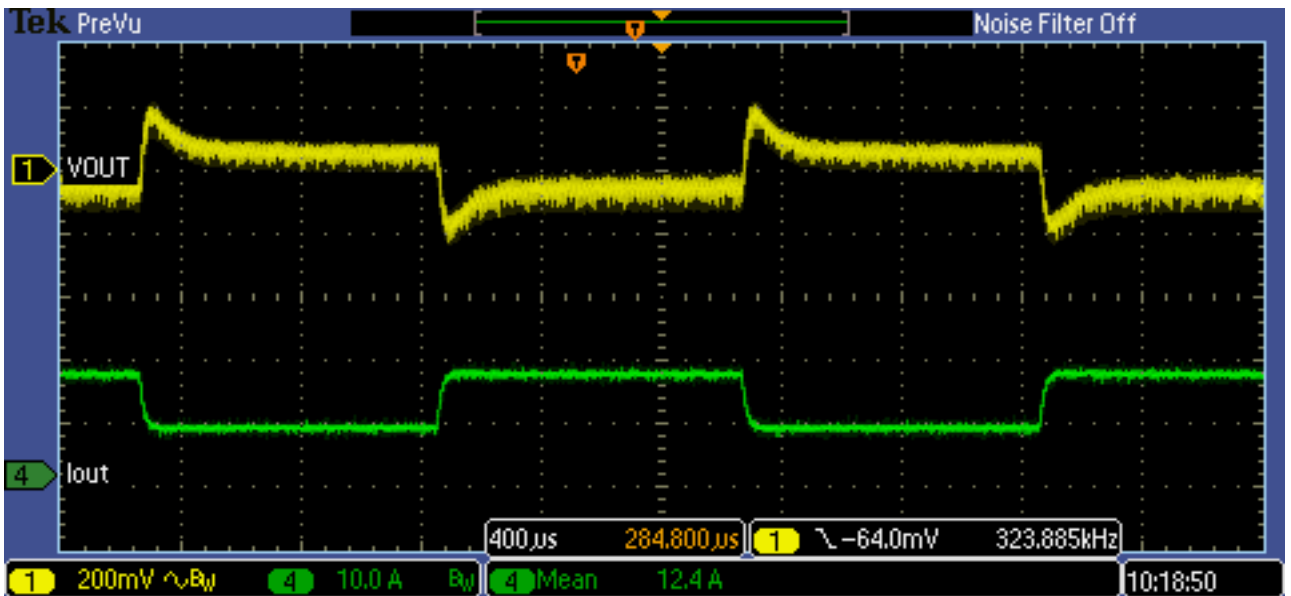

Iout: 10A/div Vout: 200mV/div 400us/div
 Dynamic Load Response (50% to 100% Load, 220Vac input)

2.11 Response to brownout characteristics

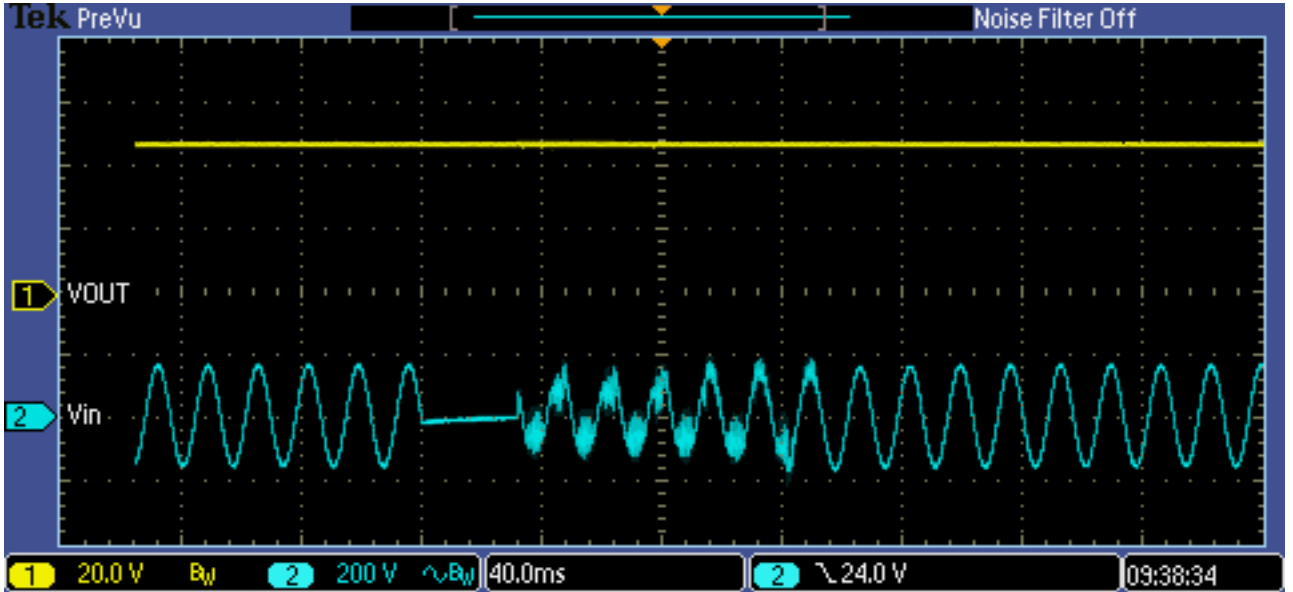

Vin: 200V/div Vout: 20V/div 40ms/div
Vin: 110VAC - 32mS Dropout (100% Load)

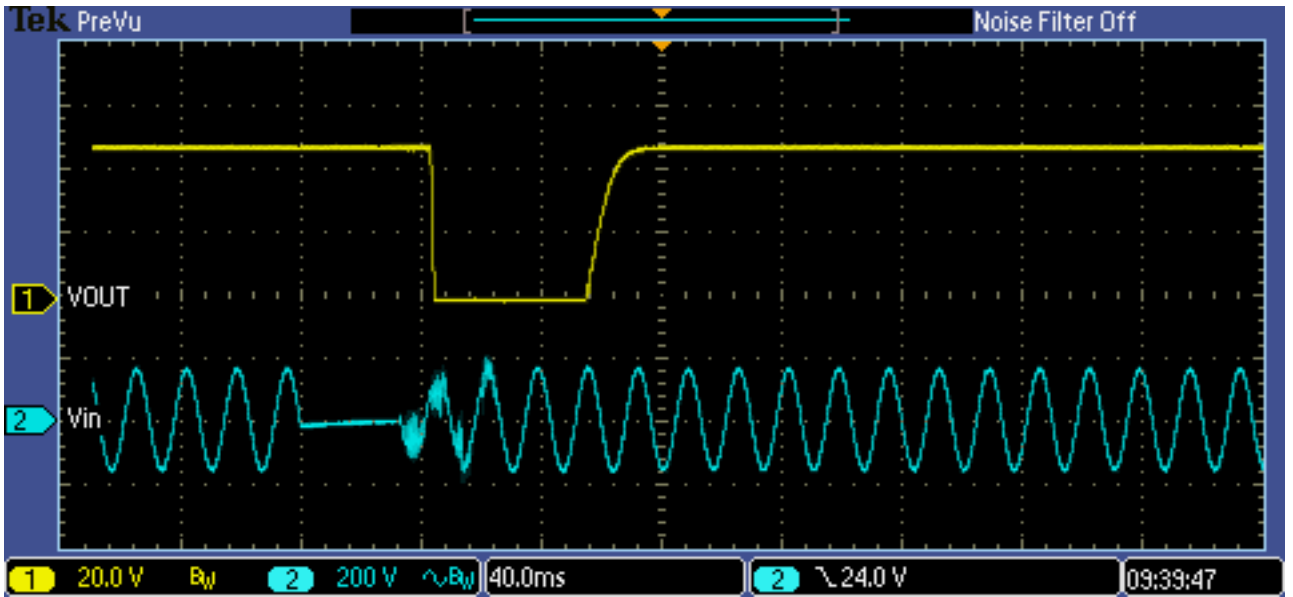

Vin: 200V/div Vout: 20V/div 40ms/div
Vin: 110VAC - 33mS Dropout (100% Load)

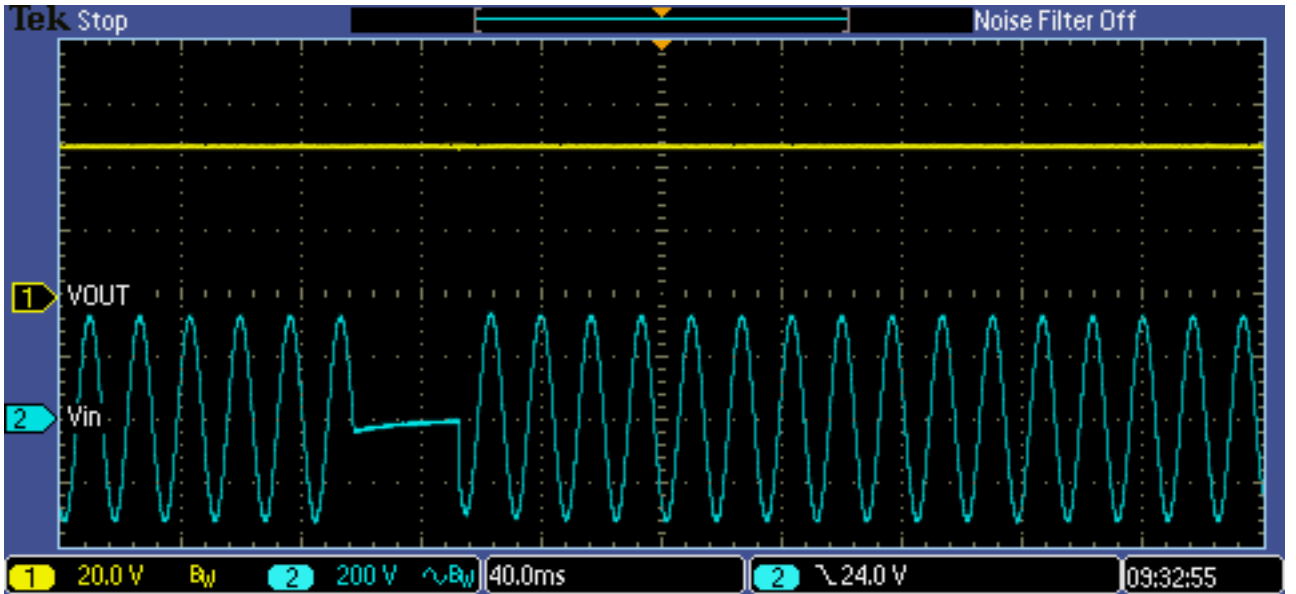

Vin: 200V/div Vout: 20V/div 40ms/div
 Vin: 220VAC - 35mS Dropout (100% Load)

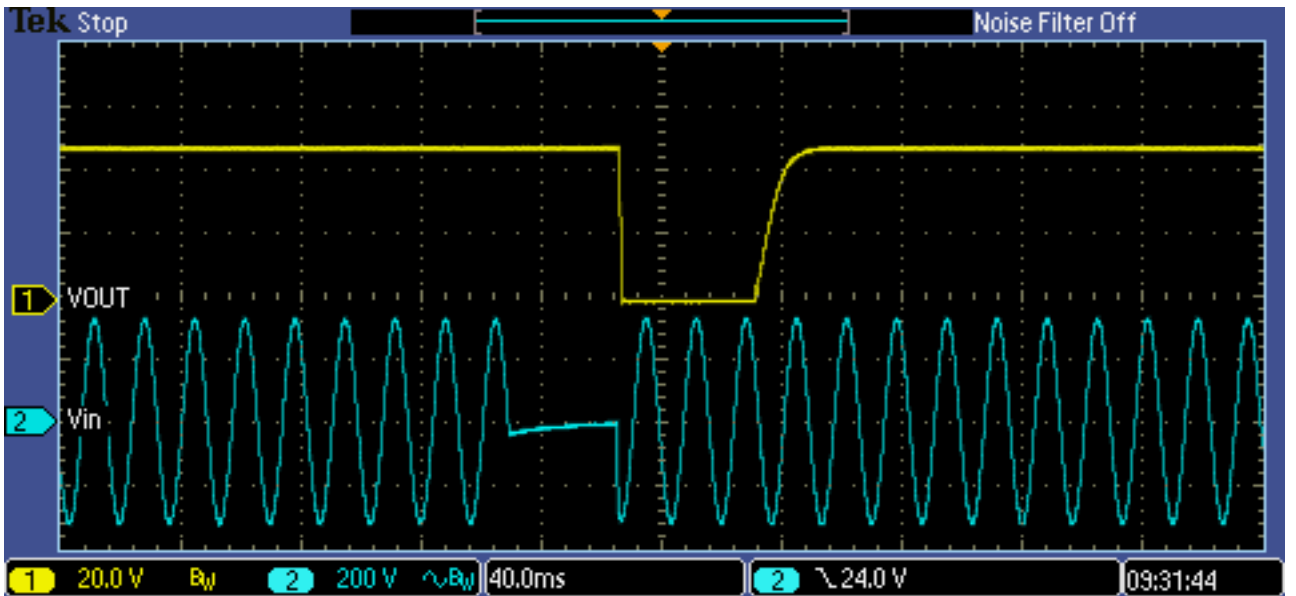

Vin: 200V/div Vout: 20V/div 40ms/div
 Vin: 220VAC - 36mS Dropout (100% Load)

2.12 Inrush current characteristics

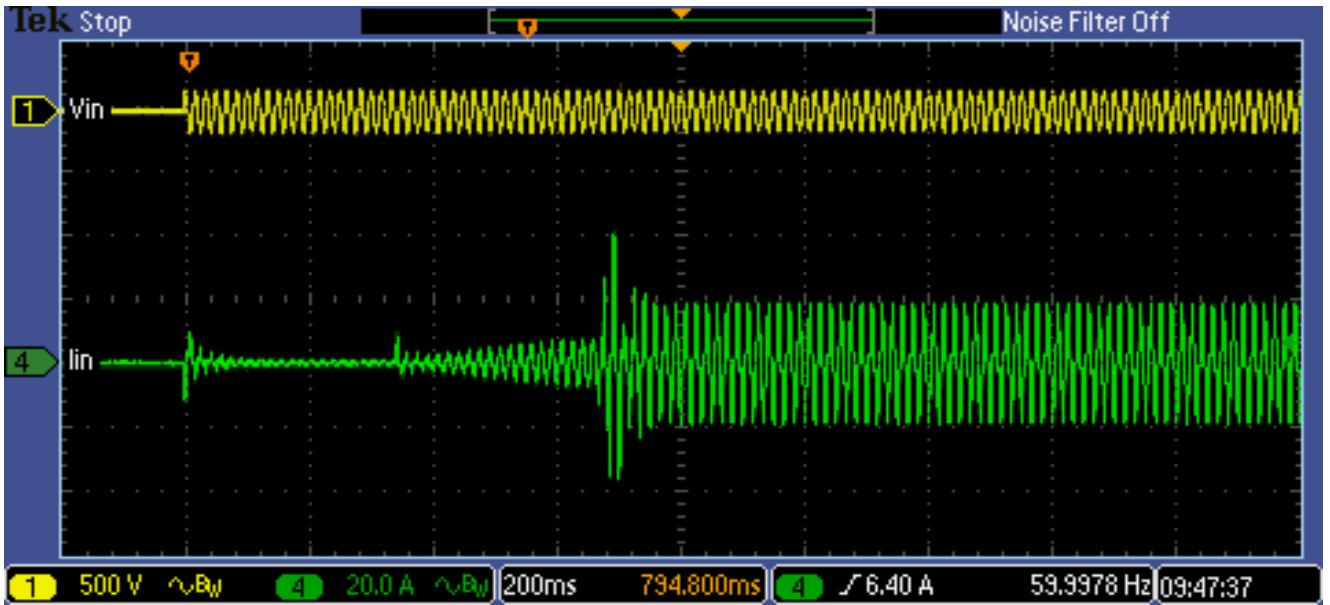

lin: 20A/div Vin: 500V/div 200ms/div
Inrush Current (100% Load, 110VAC Input)

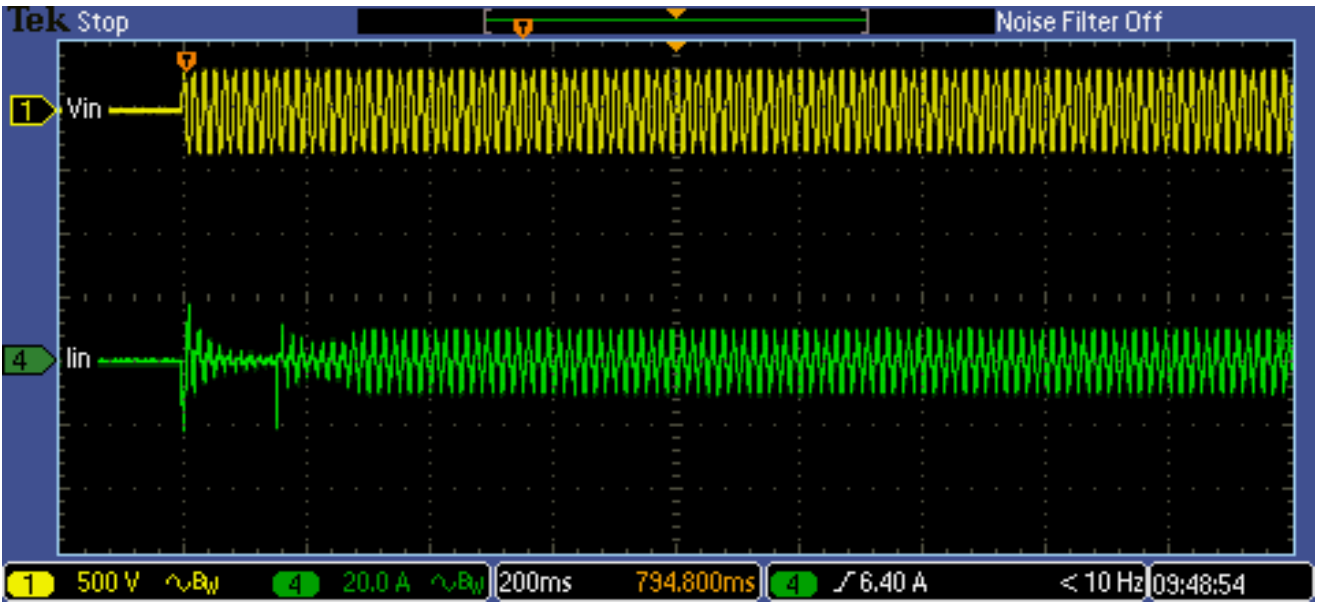

lin: 20A/div Vin: 500V/div 40ms/div
Inrush Current (100% Load, 220VAC Input)

2.13 Input current waveforms

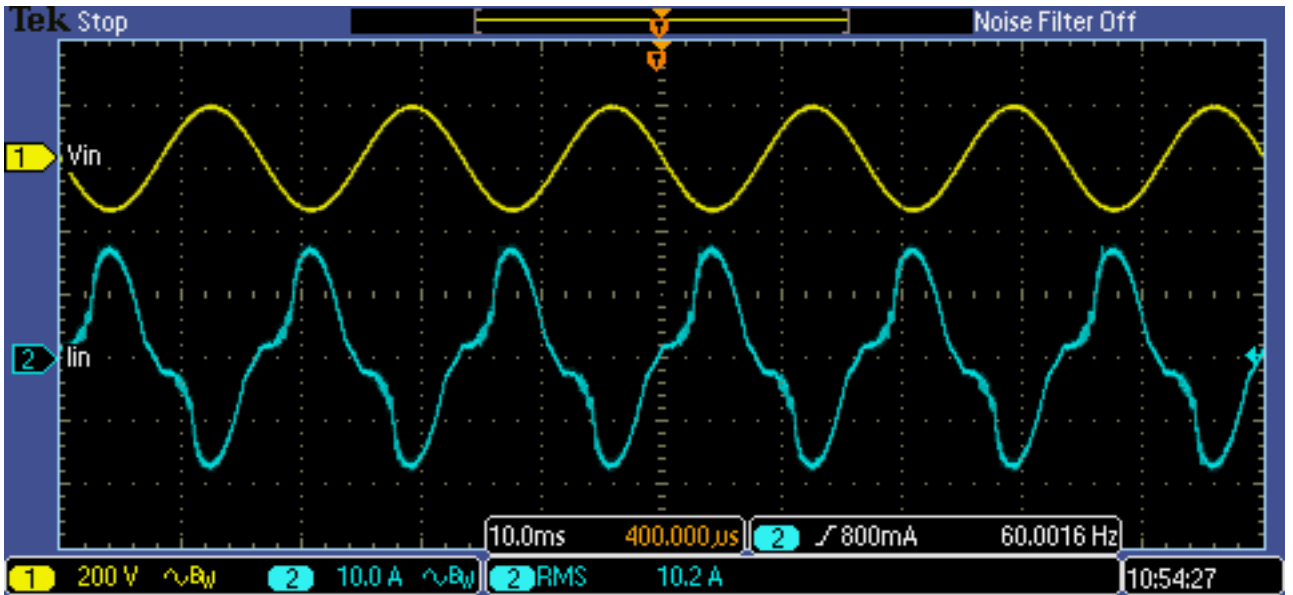

Iin: 10A/div Vin: 200V/div 10ms/div
 Input Current (100% Load, 110VAC Input)

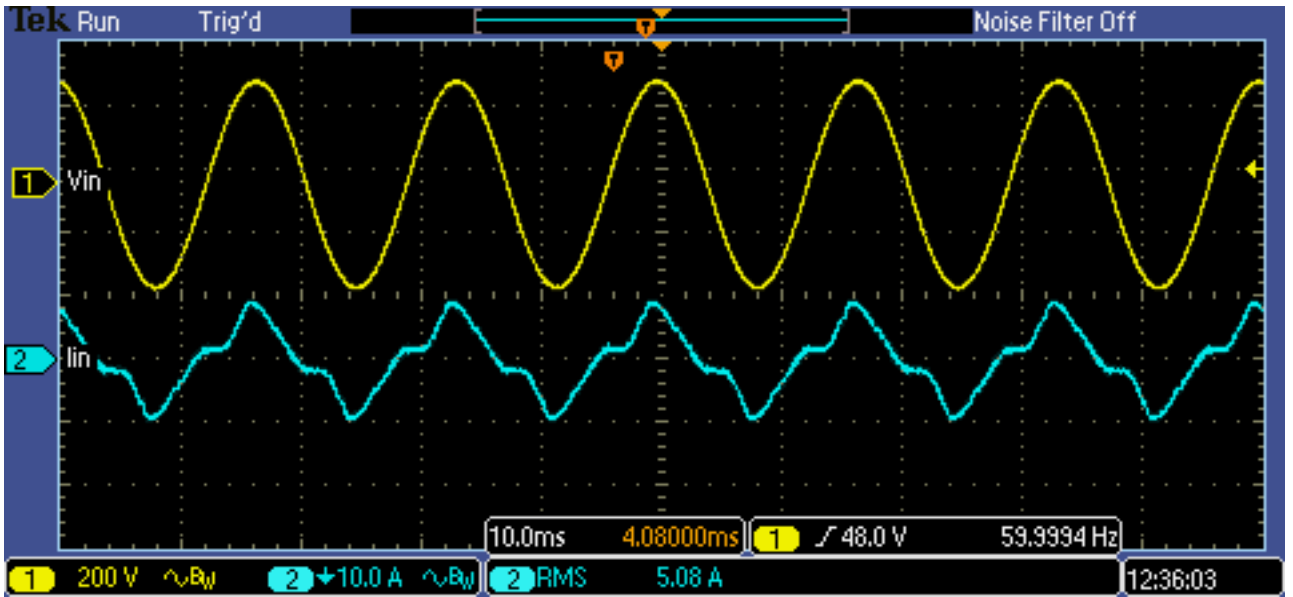

Iin: 10A/div Vin: 200V/div 10ms/div
 Input Current (100% Load, 220VAC Input)

2.14 Input current harmonics

CPFE1000F-48		
Vin	230 VAC	
Freq	50 HZ	
Io	21 ADC	
Vo	48 VDC	
Iin	5.34	
Harmonics	Limit (A)	A
2	1.08	0.0339
3	2.3	1.49
4	0.43	0.0126
5	1.14	0.4995
6	0.3	0.0028
7	0.77	0.0758
8	0.23	0.005
9	0.4	0.1055
10	0.184	0.0017
11	0.33	0.0699
12	0.153	0.0005
13	0.21	0.0388
14	0.131	0.0028
15	0.15	0.0528
16	0.11	0.0021
17	0.132	0.0542
18	0.102	0.0023
19	0.118	0.011
20	0.092	0.0009
21	0.107	0.0463
22	0.084	0.0019
23	0.098	0.024
24	0.077	0.0011
25	0.09	0.0182
26	0.071	0.0029
27	0.083	0.0508
28	0.066	0.0012
29	0.078	0.0289
30	0.061	0.0039
31	0.073	0.033
32	0.058	0.0019
33	0.068	0.0215
34	0.054	0.0037
35	0.064	0.0088
36	0.051	0.0021
37	0.061	0.0223
38	0.048	0.0023
39	0.058	0.0027
40	0.046	0.002

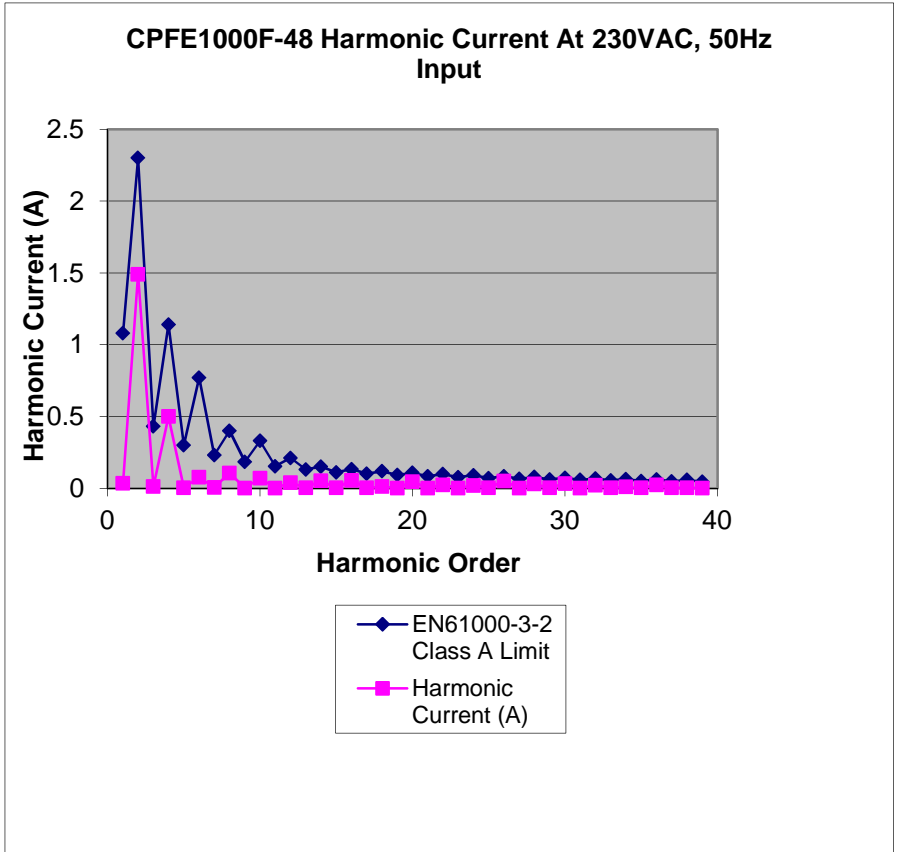

2.15 Leakage current characteristics

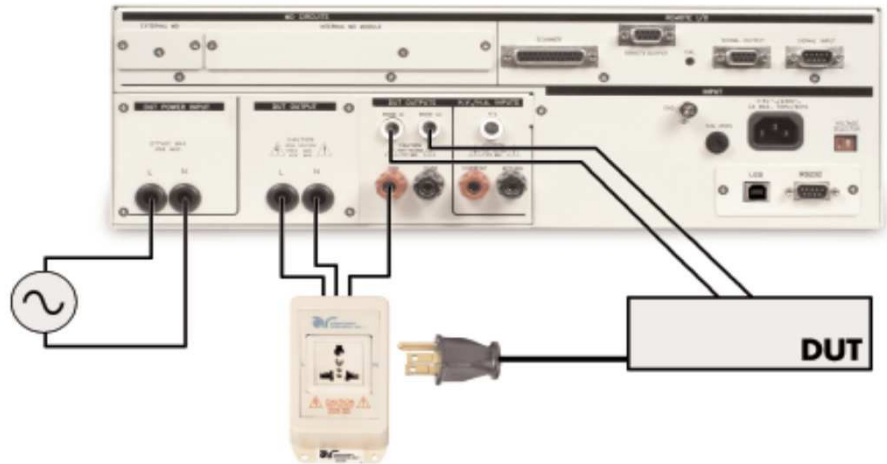
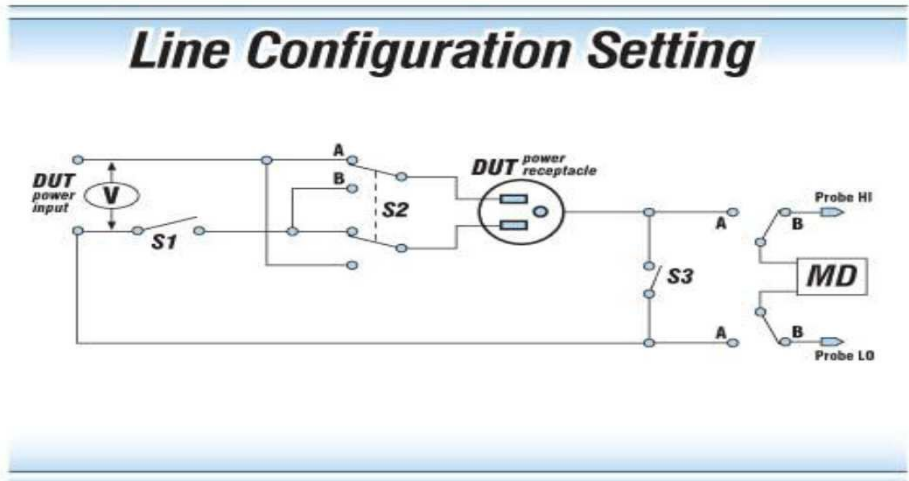

PS Vout	Time (s)	Freq (Hz)	Nom.1 110VAC	Nom.2 220VAC	265VAC	Configuration		
						Neutral	S2	S3
48	10	60	<1.5mA 0.2480	<1.5mA 0.5070	<1.5mA 0.6290	Closed	Normal	Open
	10	60	0.2550	0.5180	0.6420	Closed	Reverse	Open

2.16 Output ripple and noise waveforms

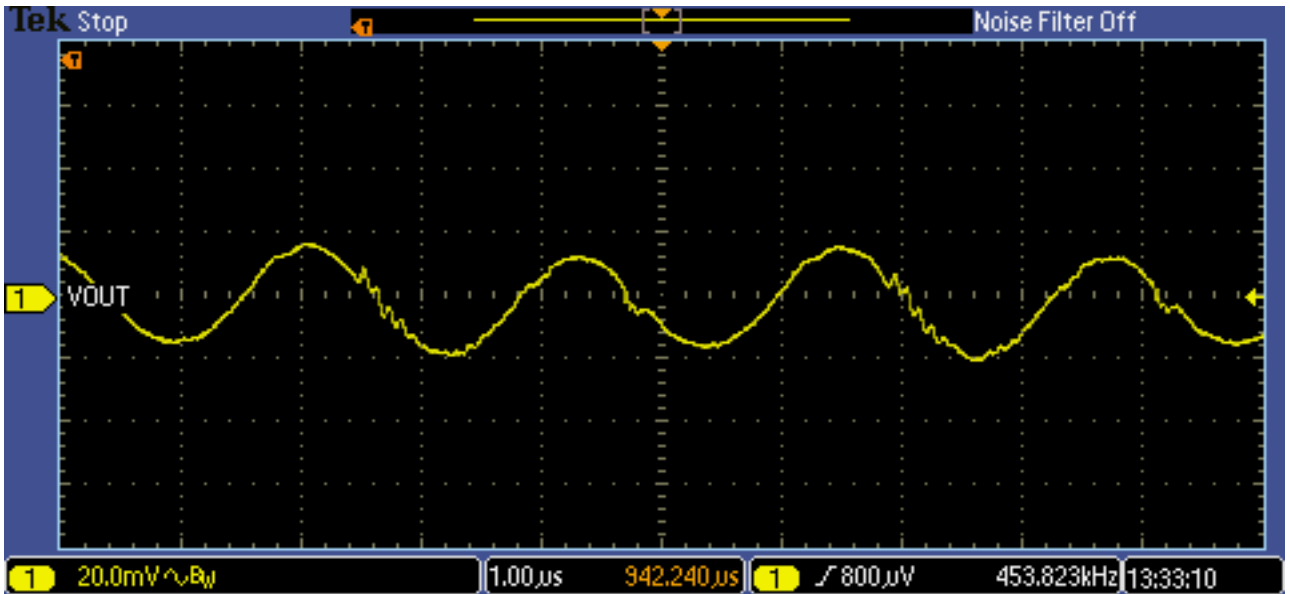

Vout: 20mV/div 1us/div
Output Ripple (100% Load, 110VAC input)

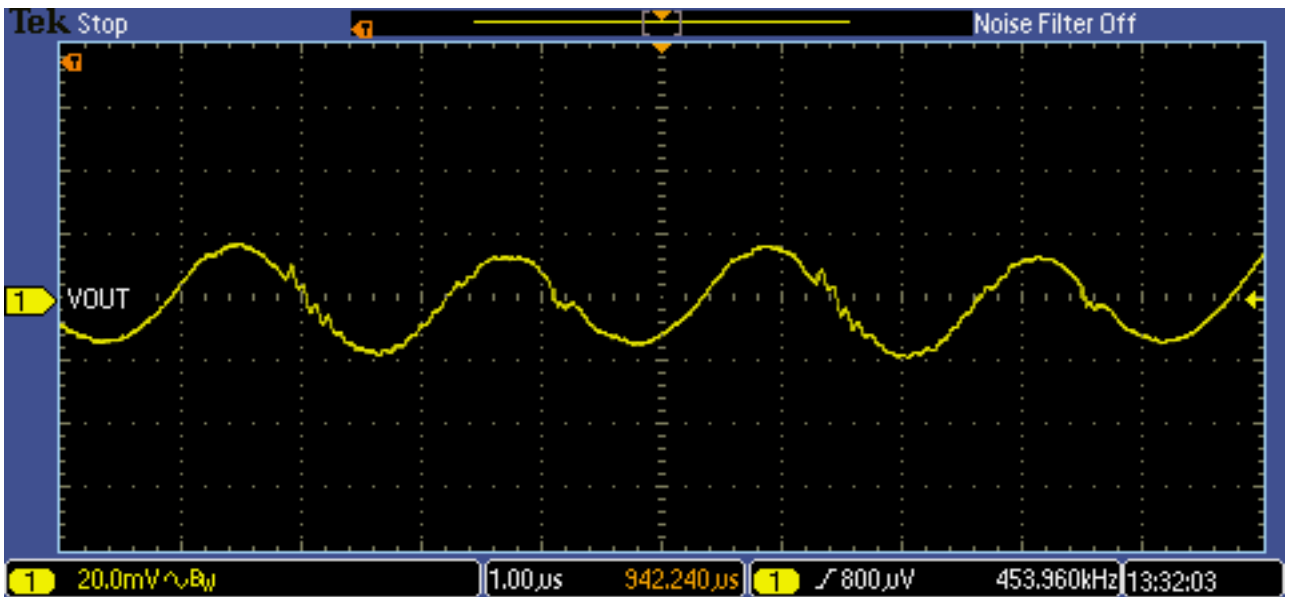

Vout: 20mV/div 1us/div
Output Ripple (100% Load, 220VAC input)