

QUALITY TEST DATA

KWD15

DWG. NO.		PA775-53-01			
QA APPROVAL		R / D			
NLJ	NLA	APP	CHK	ENG	DRW
<i>T. Murugesan</i>	<i>[Signature]</i>	<i>[Signature]</i>	CONEO	RAMESH.M	RAMESH.M
'93.10.18	4/12/92	24/DEC/92	5/12/92	4/12/92	4/12/92

[Signature]
24/12/92 T. S. S. S.
93.10.18

-----INDEX-----

1.	Specifications	-----1
2.	Evaluation Method	
2 -- 1	Circuits used for determination	-----2-4
	(1) Steady state data	
	(2) Warm up voltage drift	
	(3) Over-current protection (O.C.P) characteristics	
	(4) Over-voltage protection (O.V.P) characteristics	
	(5) Output rise characteristics	
	(6) Output fall characteristics	
	(7) Dynamic line response	
	(8) Dynamic load response	
	(9) Inrush current characteristics	
	(10) Leakage current	
	(11) Output ripple, noise	
2 -- 2	List of equipment	-----5
3.	Characteristics	
3 -- 1	Steady state data	-----6-12
	(1) Regulation -- line and load, temp. drift	
	(2) Output voltage and ripple voltage vs input voltage	
	(3) Efficiency and input current vs output current	
3 -- 2	Warm up voltage drift	-----13-14
3 -- 3	O.C.P. characteristics	-----15-16
3 -- 4	O.V.P. characteristics	-----17

3 -- 5	Output rise time	-----18-21
3 -- 6	Output fall time	-----22-25
3 -- 7	Hold up time	-----26-27
3 -- 8	Dynamic line response	-----28-31
3 -- 9	Dynamic load response	-----32-39
3 -- 10	Response to brown out	-----40-43
3 -- 11	Inrush current characteristics	-----44
3 -- 12	Inrush current waveform	-----45-46
3 -- 13	Leakage current	-----47
3 -- 14	Output ripple, noise	-----48-51

Terminology used :

	Defination
Vin ...	Input voltage
Vout ...	Output voltage
Iin ...	Input current
Iout ...	Output current
Ta ...	Ambient temperature

KWD15 Specifications

NEMIC-LAMBDA

PA775-01-01

*: For delivery, contact to our sales office.

ITEMS	MODEL	KWD15-1212		KWD15-1515		
		CH1	CH2	CH1	CH2	
1	Nominal Output Voltage	V	+12V (24V)	-12V	+15V (30V)	-15V
2	Minimum Output Current	A	0	0	0	0
3	Maximum Output Current	A	0.65	0.65	0.52	0.52
4	Maximum Output Power	W	15.6		15.6	
5	Efficiency (typ)	(*1) %	75		75	
6	Input Voltage Range	(*2) -	85 ~ 265VAC (47~440Hz) or 110 ~ 340VDC			
7	Input Current (typ)	(*1) A	0.4A at 100VAC			
8	Inrush Current (typ)	A	20A at 100VAC, 40A at 200VAC Ta = 25°C			
9	Output Voltage Range	-	FIXED ±5% (Max)		FIXED ±5% (Max)	
10	Maximum Ripple & Noise	(*3) mV	150	150	150	150
11	Maximum Line Regulation	(*3,*4) mV	60	60	75	75
12	Maximum Load Regulation	(*3,*5) mV	600	600	750	750
13	Maximum Temperature Drift	(*3,*6) mV	120	120	150	150
14	Over Current Protection	(*7) -	105% ~			
15	Over Voltage Protection	(*8) -	110% ~			
16	Parallel Operation	-	-----			
17	Series Operation	-	Possible			
18	Hold-Up Time (typ)	-	17mS at 15W, 100VAC, Ta = 25°C			
19	Operating Temperature	-	-10°C ~ +70°C (-10°C : 80%, 0~+50°C : 100%, +70°C : 25%)			
20	Operating Humidity	-	30 ~ 90%RH (No dewdrop)			
21	Storage Temperature	-	-30 ~ +85°C			
22	Storage Humidity	-	20%RH ~ 95%RH (No dewdrop)			
23	Cooling	-	Convection Cooling			
24	Withstand Voltage	-	Input-Output : 3kVAC(20mA), Input-FG : 2kVAC(20mA) Output-FG : 500VAC(100mA) for 1minute each.			
25	Isolation Resistance	-	More than 100MΩ at 25°C and 70%RH Output-FG 500VDC			
26	Vibration	-	10~55Hz, Constant Amplitude 1.65mm p-p (Max 10G), sweep 1 Minute X,Y,Z 1 hour each			
27	Shock	-	Less than 50G for 11±5mS on ± (X, Y, Z) axis each 3 times			
28	Safety	-	Approved by UL1950, CSA234, EN60950(TUV)			
29	Conducted Radio Noise	(*9) -	Built to meet VCCI-Class B, FCC class B, VDE classB			
30	Weight	g	150g			
31	Size (WxHxD)	mm	48 x 23.5 x 70 (Refer to Outline Drawing)			

* Read Instruction manual carefully, before using the power supply unit.

= NOTES =

- *1. At 100VAC and Maximum Output Power, Ta=25C.
- *2. For cases where conformance to various safety specs (UL, CSA,TUV) are required to be described as 100-240VAC, 50/60Hz on name plate.
- *3. Please refer to Fig. A for measurement determination of line & load regulation and output ripple & noise voltage.
- *4. From 85~265VAC, constant load.
- *5. From Min load - Full load (Maximum power), constant input Voltage.
- *6. From 0~50°C, constant input voltage and load.
- *7. Current limiting with automatic recovery. Avoid to operate over load or dead short for more than 30 seconds.
- *8. Over Voltage Clamping by Zener Diode (on CH2 only).
- *9. VDE classB with external capacitor.

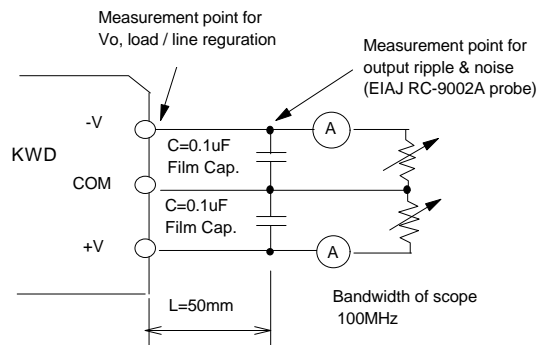
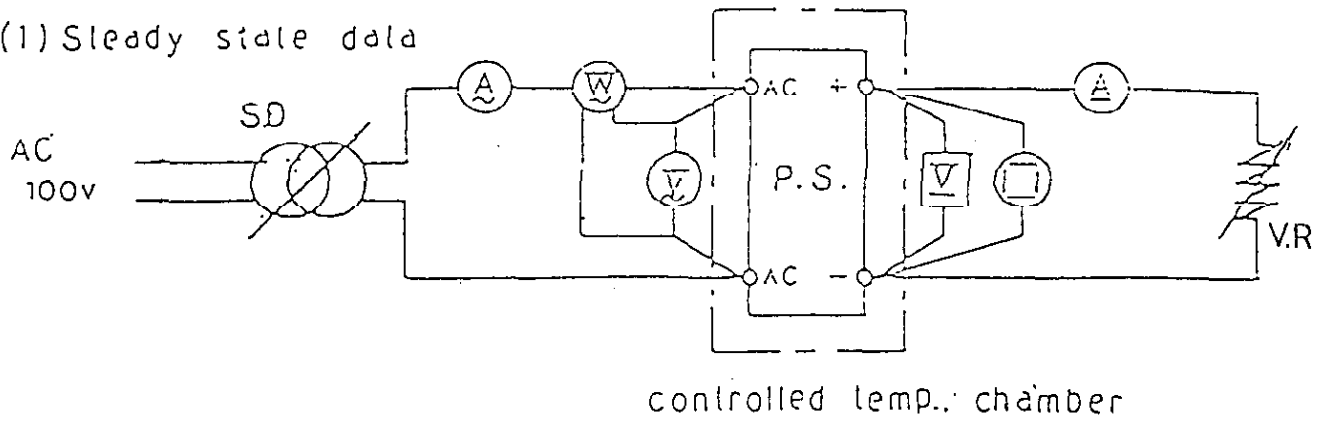

Fig.A

Circuits used for determination

(1) Steady state data



(2) Warm up voltage drift

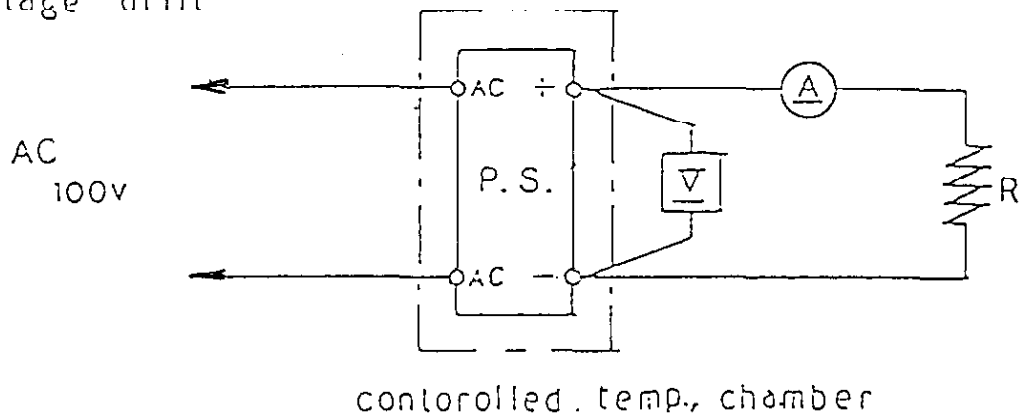

(3) Over current protection (o.c.p) characteristics

Same as steady state data.

(4) Over voltage protection (o.v.p) characteristics

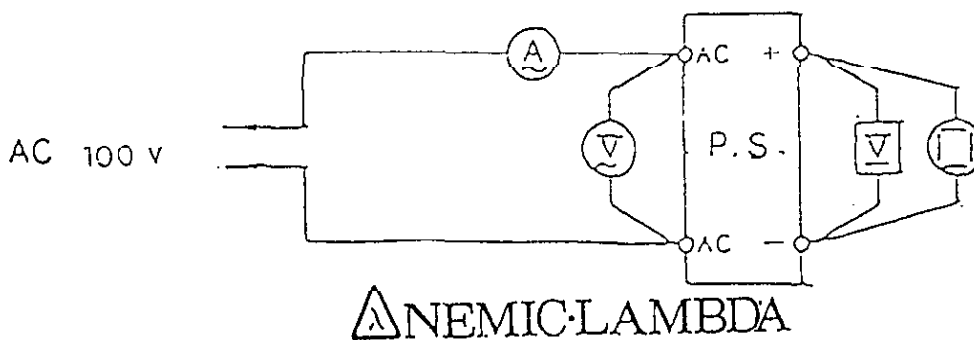

(5) Output rise characteristics

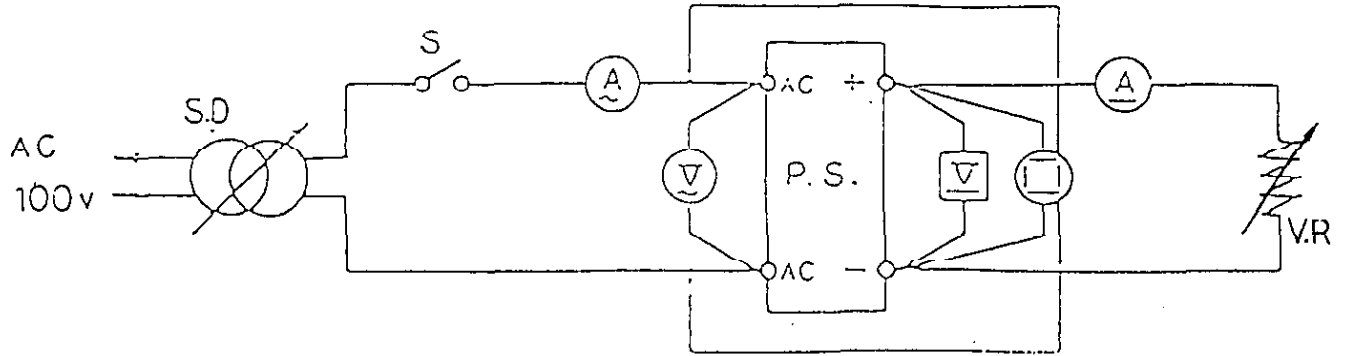

(6) Output fall characteristics

Same as output rise characteristics.

(7) Dynamic line response

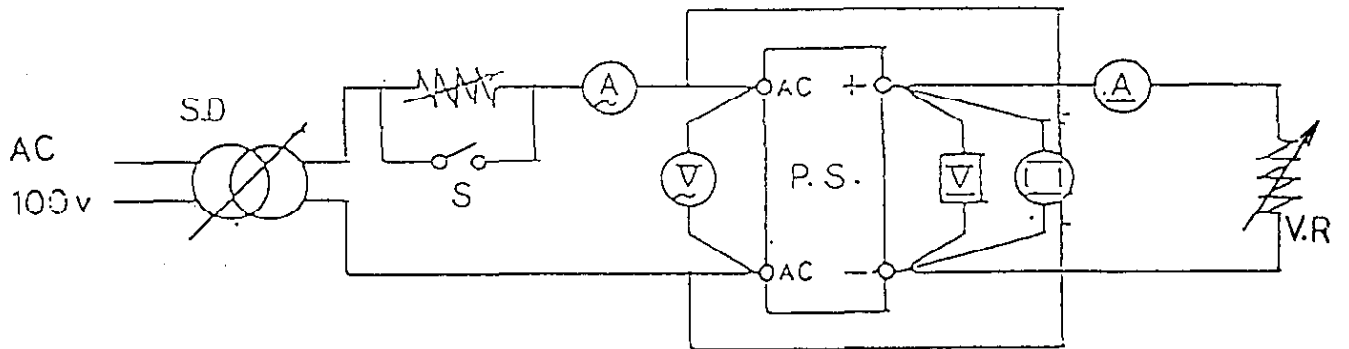

(8) Dynamic load response

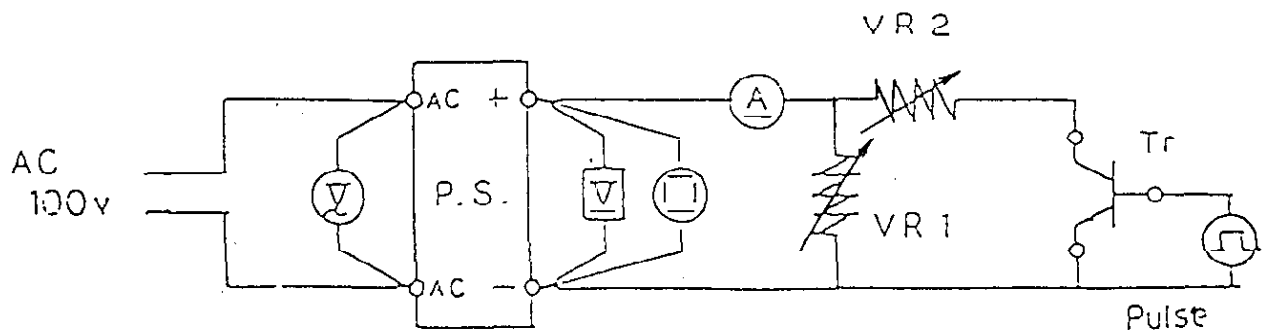

(9) Inrush current characteristics

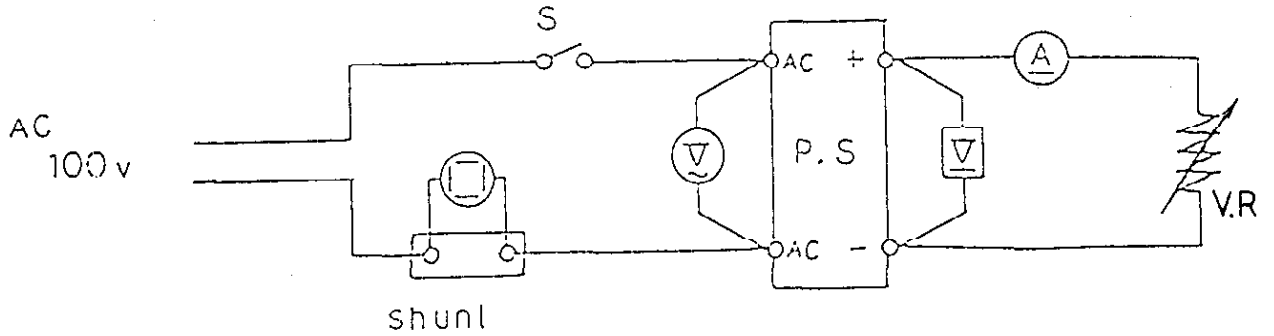

(10) Leakage current

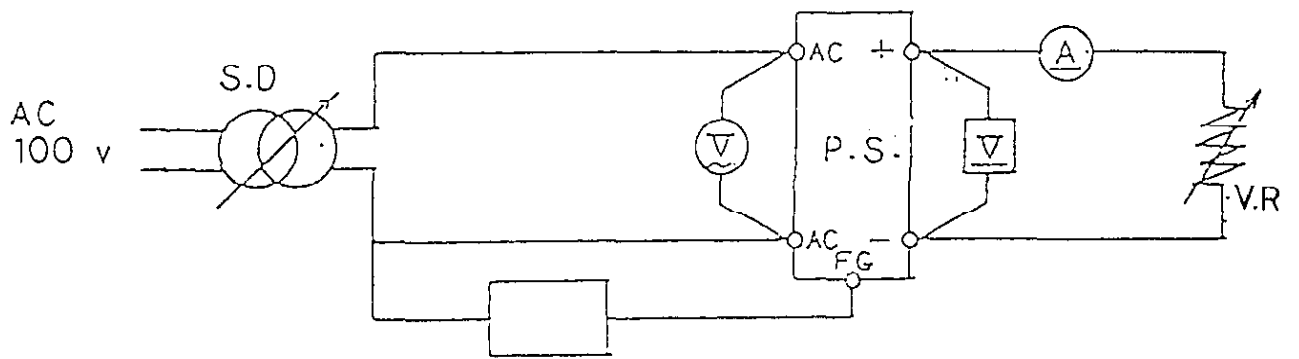

leakage current meter

Note : -Leakage current measured through a $1k\Omega$ resistor.

-Range used -- AC ÷ DC

$R = 50\Omega$
 $C1 = 4700pF$
 $C2 = 0.1\mu F$
 (Ch1/Ch2/Ch1+Ch2)

(11) Output-ripple, noise

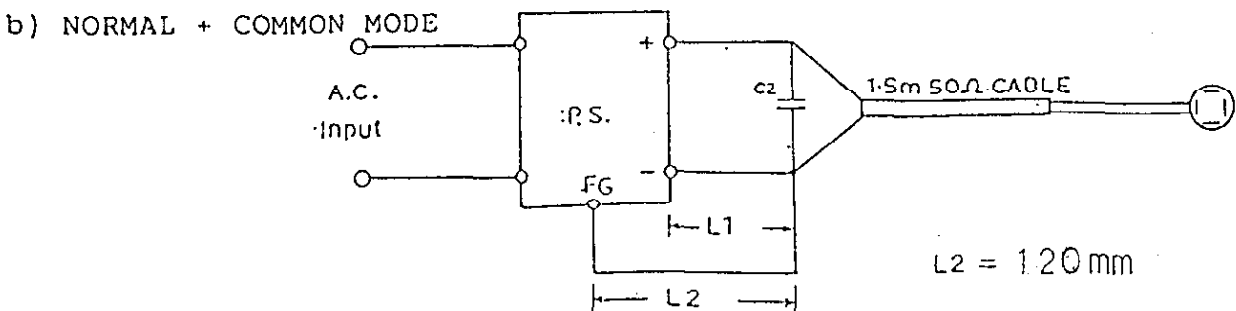
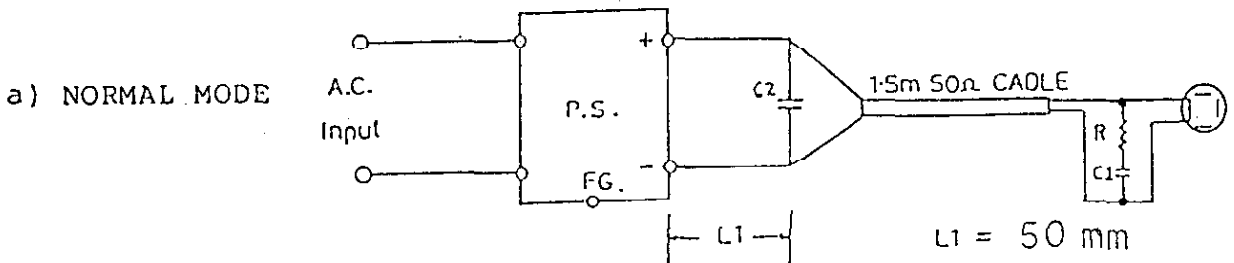

List of equipment used

	EQUIPMENT USED	MANUFACTURER	MODEL NO.
1	Oscilloscope	HITACHI DENSHI	V-1065
2	Digital storage oscilloscope	HITACHI DENSHI	VC-6041
3	Digital voltmeter	IWATSU	VDAC 7411
4	Digital watt/current/volt meter	HIOKI	3182
5	DC Ampere meter	YOKOGAWA ELECTRIC	2051
6	Autotransformer	SUPERIOR ELECTRIC	136 ST
7	Variable resistive load	IWASHITA ELECTRIC	D 5-10/16
8	Dynamic dummy load	TAKAMIZAWA CYBERNETICS KIKUSUI	PSA-1500 PLZ72W, PLZ150WA
9	Digirush currenter	TAKAMIZAWA CYBERNETICS	PSA-200
10	Current Probe/Amplifier	TEKTRONIX	A6303/AM503
11	Controlled Temp. Chamber	TABAI	PL-2GN
12	Leakage current meter	YOKOGAWA ELECTRIC	3226
13	Equipment for dynamic line response	- BUILT IN-HOUSE	

+12V

1. Regulation - line and load

Condition Ta : 25°C
-12V: 0.65A

Iout	Vin	AC 85V	AC100V	AC220V	AC265V	Line Regulation	
0 %		12.227V	12.227V	12.233V	12.232V	6 mV	0.05 %
50 %		12.060V	12.060V	12.060V	12.060V	0 mV	0.00 %
100 %		11.979V	11.980V	11.980V	11.980V	1 mV	0.01 %
Load		248mV	247mV	253mV	252mV		
Regulation		2.07 %	2.06 %	2.11 %	2.10 %		

2. Temperature Drift

Condition Vin : AC100V
Iout : 100 %

Ta	0 °C	25 °C	50 °C	Temp. Stability	
Vout	11.957V	11.980V	11.985V	28 mV	0.23 %

12V

1. Regulation - line and load

Condition Ta : 25°C
+12V: 0.65A

Iout	Vin	AC 85V	AC100V	AC220V	AC265V	Line Regulation	
0 %		-12.222V	-12.222V	-12.218V	-12.219V	4 mV	0.03 %
50 %		-12.064V	-12.062V	-12.061V	-12.061V	3 mV	0.03 %
100 %		-11.976V	-11.976V	-11.977V	-11.976V	1 mV	0.01 %
Load		246mV	246mV	241mV	243mV		
Regulation		2.05%	2.05%	2.01%	2.03%		

2. Temperature Drift

Condition Vin : AC100V
Iout : 100 %

Ta	0 °C	25 °C	50 °C	Temp. Stability	
Vout	-11.956V	-11.976V	-11.981V	25 mV	0.21 %

+15V

1. Regulation - line and load

Condition Ta : 25 °C
-15V: 0.52A

Iout	Vin	AC 85V	AC100V	AC220V	AC265V	Line Regulation	
0 %		15.176V	15.176V	15.176V	15.177V	1 mV	0.01%
50 %		15.034V	15.031V	15.030V	15.029V	5 mV	0.03 %
100 %		14.951V	14.953V	14.956V	14.956V	5 mV	0.03 %
Load		225mV	223mV	220mV	221mV		
Regulation		1.50 %	1.49 %	1.47 %	1.47 %		

2. Temperature Drift

Condition Vin : AC100V
Iout : 100 %

Ta	0 °C	25 °C	50 °C	Temp. Stability	
Vout	14.988V	14.953V	14.917V	71 mV	0.47 %

-15V

1. Regulation - line and load

Condition Ta : 25 °C
+15V: 0.52A

Iout	Vin	AC 85V	AC100V	AC220V	AC265V	Line Regulation	
0 %		-15.162V	-15.162V	-15.160V	-15.158V	4 mV	0.03 %
50 %		-15.022V	-15.018V	-15.016V	-15.016V	6 mV	0.04 %
100 %		-14.938V	-14.938V	-14.938V	-14.938V	0 mV	0.00 %
Load		224mV	224mV	222mV	220mV		
Regulation		1.49%	1.49%	1.48%	1.47%		

2. Temperature Drift

Condition Vin : AC100V
Iout : 100 %

Ta	0 °C	25 °C	50 °C	Temp. Stability	
Vout	-14.977V	-14.938V	-14.911V	66 mV	0.44 %

24V

1. Regulation - line and load

Condition Ta : 25°C

Iout	Vin	AC 85V	AC100V	AC220V	AC265V	Line Regulation	
0 %		23.968V	23.968V	23.972V	23.970V	4 mV	0.02 %
50 %		23.966V	23.966V	23.966V	23.963V	0 mV	0.00 %
100 %		23.956V	23.956V	23.958V	23.958V	2 mV	0.01 %
Load		12 mV	12 mV	14 mV	12 mV		
Regulation		0.05 %	0.05 %	0.06 %	0.05 %		

2. Temperature Drift

Condition Vin : AC100V
Iout : 100 %

Ta	0 °C	25 °C	50 °C	Temp. Stability	
Vout	23.913V	23.956V	23.966V	53 mV	0.22 %

30V

1. Regulation - line and load

Condition Ta : 25°C

Iout	Vin	AC 85V	AC100V	AC220V	AC265V	Line Regulation	
0 %		29.933V	29.933V	29.938V	29.938V	5 mV	0.02 %
50 %		29.920V	29.920V	29.920V	29.920V	0 mV	0.00 %
100 %		29.889V	29.891V	29.893V	29.893V	4 mV	0.01 %
Load		44 mV	42 mV	45 mV	45 mV		
Regulation		0.15%	0.14%	0.15%	0.15%		

2. Temperature Drift

Condition Vin : AC100V
Iout : 100 %

Ta	0 °C	25 °C	50 °C	Temp. Stability	
Vout	29.965V	29.891V	29.828V	137mV	0.46 %

Output Voltage and Ripple Voltage v.s.
Input Voltage

KWD15

Condition Iout: 100%
 Ta : 0°C - - - -
 25°C - - - -
 50°C - - - -

+12V

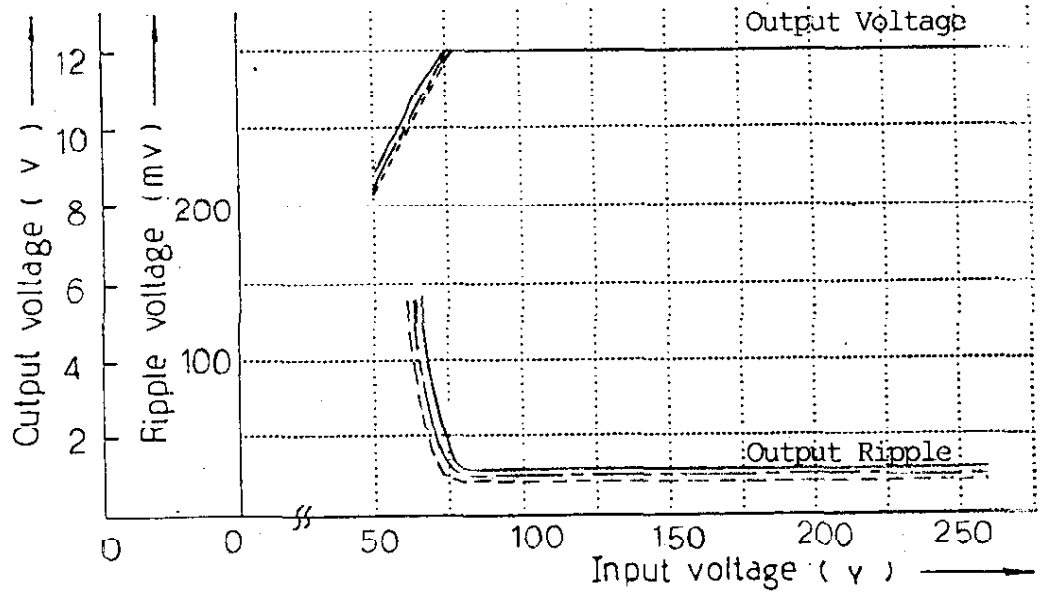

-12V

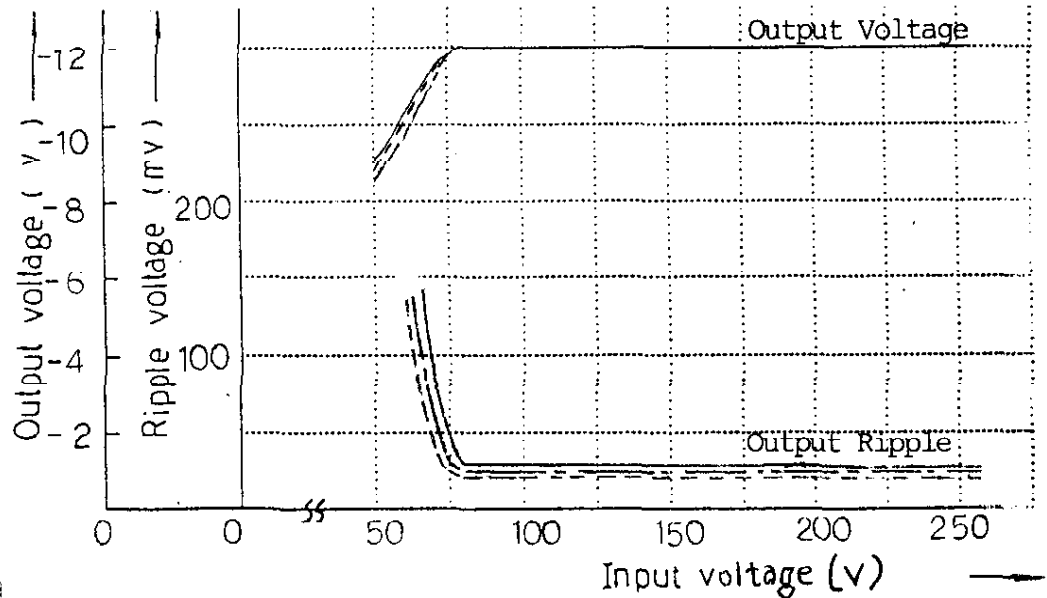

24V

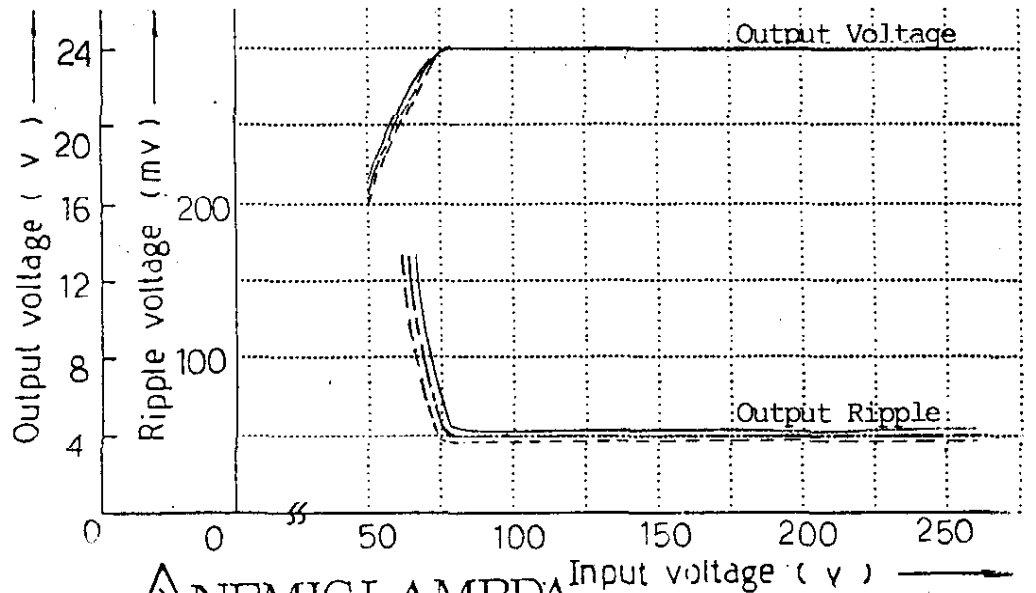

Output Voltage and Ripple Voltage v.s.
Input Voltage

KWD15

Condition Iout: 100%
Ta : 0°C ---
25°C - - -
50°C ———

+15V

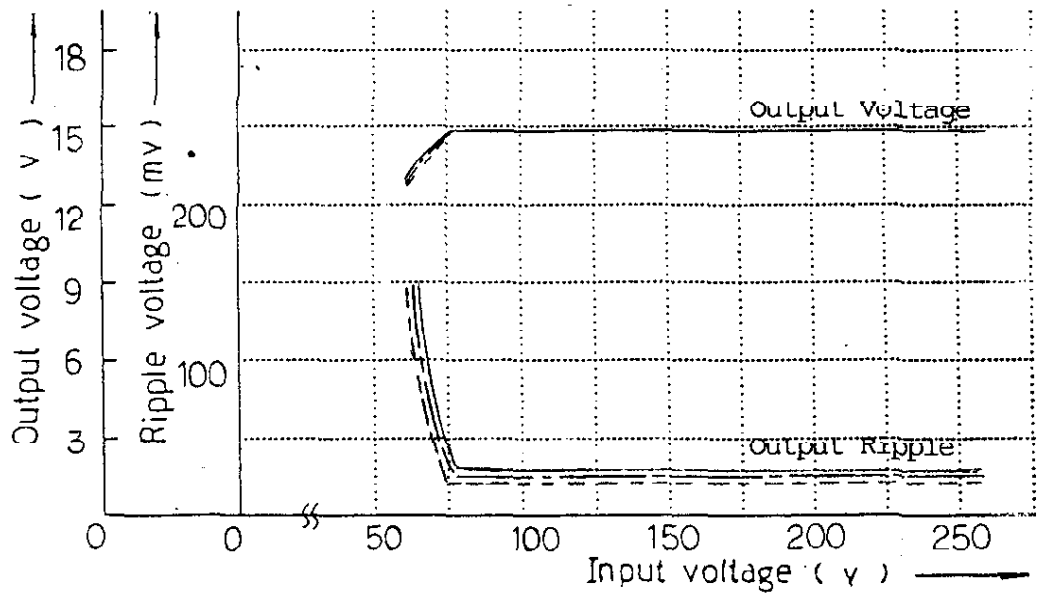

-15V

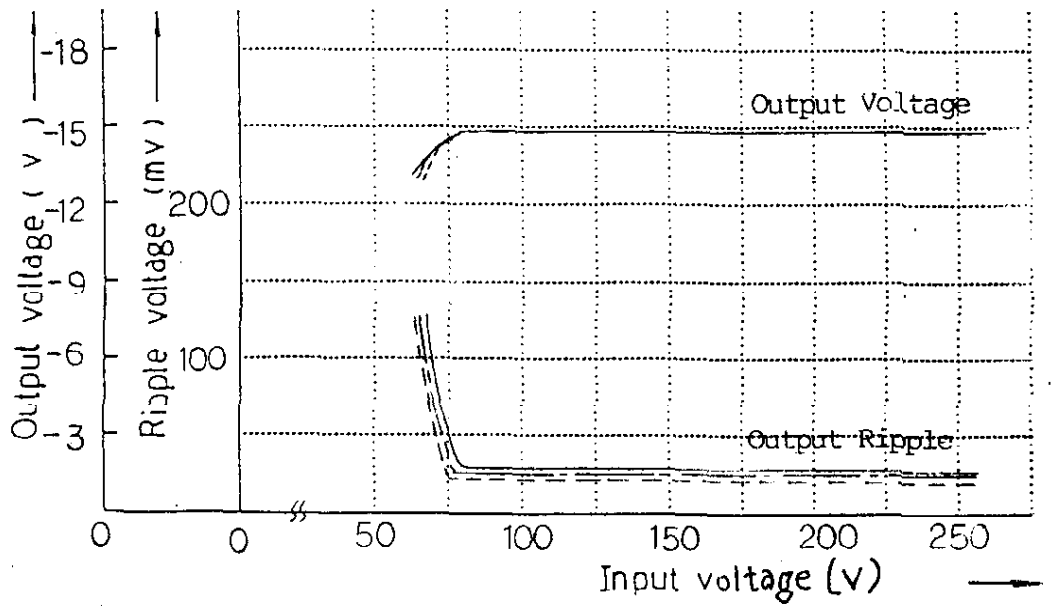

30V

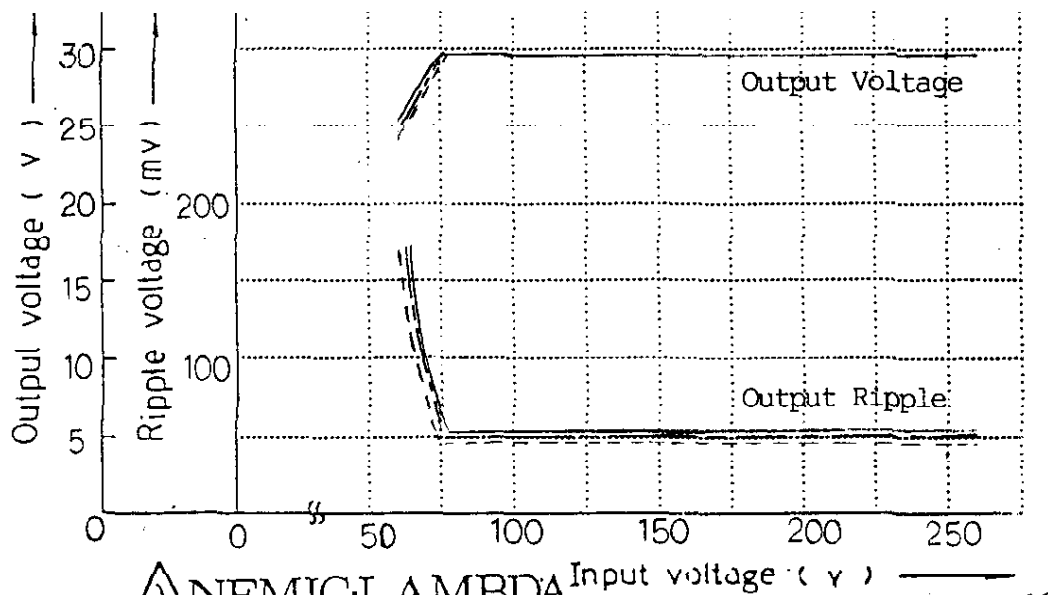

Efficiency and Input Current v.s.
Output Current

KWD15

Condition V_{in} : AC100V
 T_a : 25°C

24V

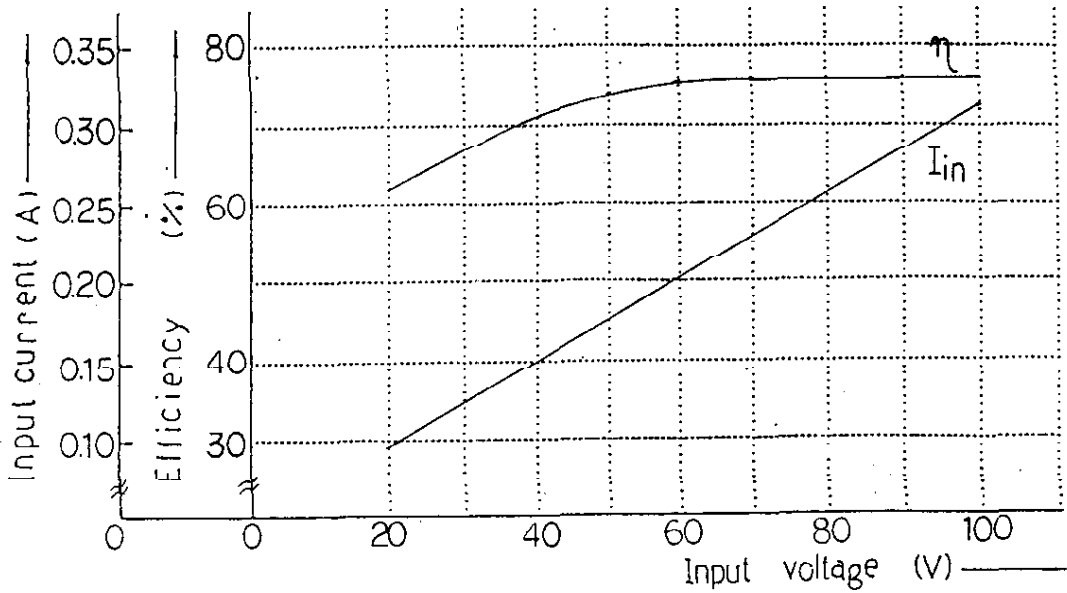

30V

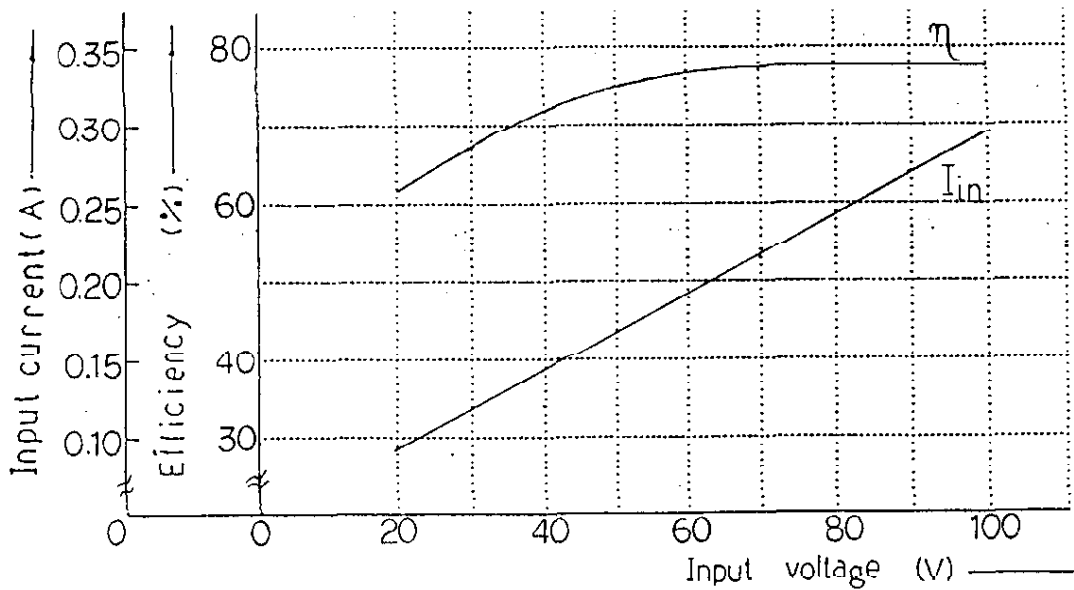

Efficiency and input Current v.s.
Output Current

KWD15

Condition Vin : AC220V
Ta : 25°C

24V

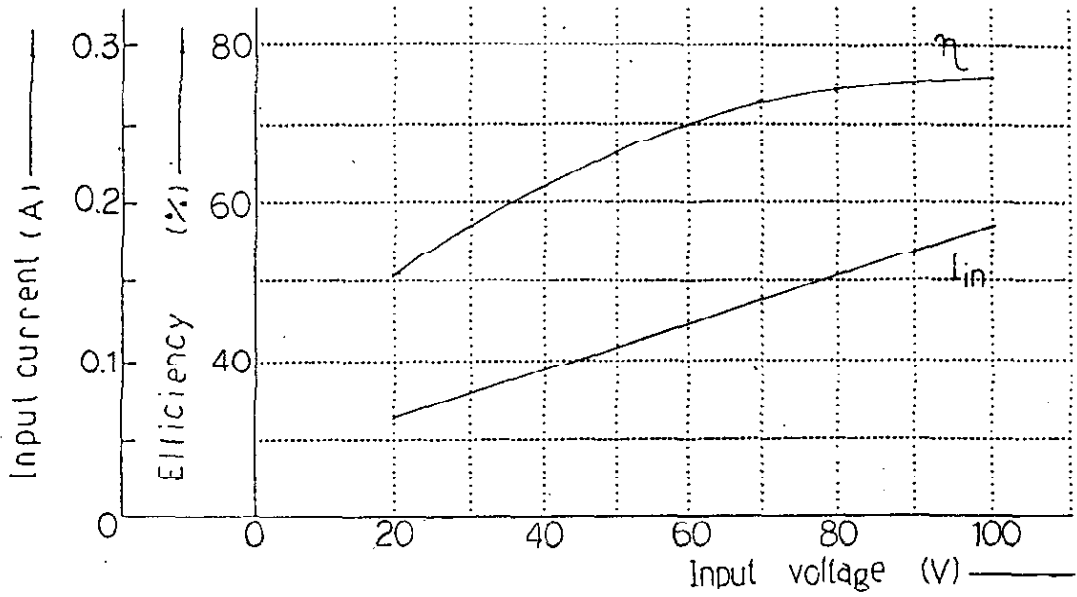

30V

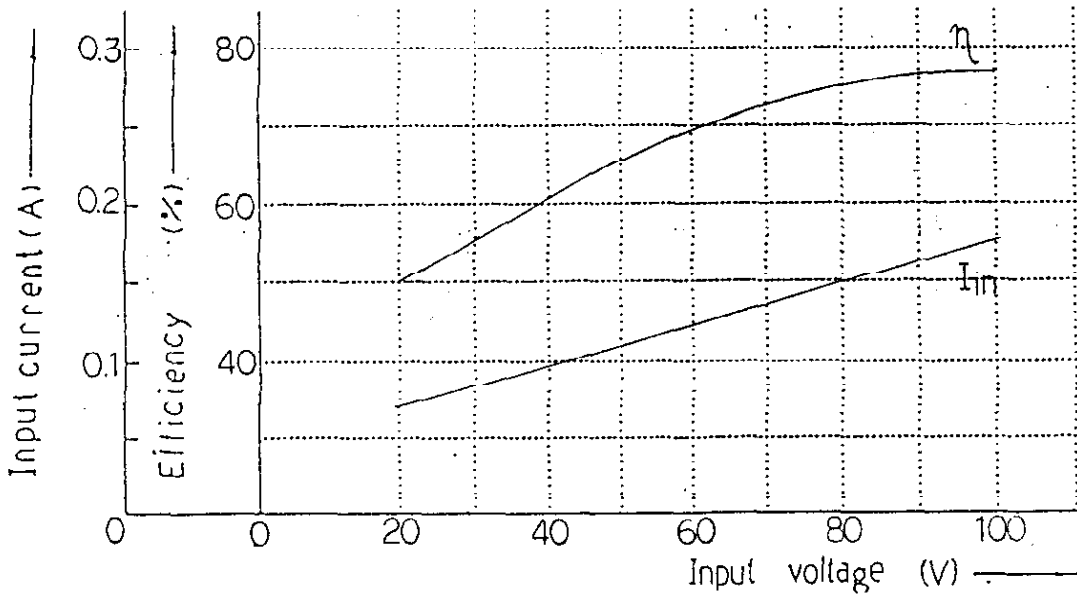

Warm Up Voltage Drift

KWD15

Condition Vin : AC100V
Iout : 100%
Ta : 25°C

+12V

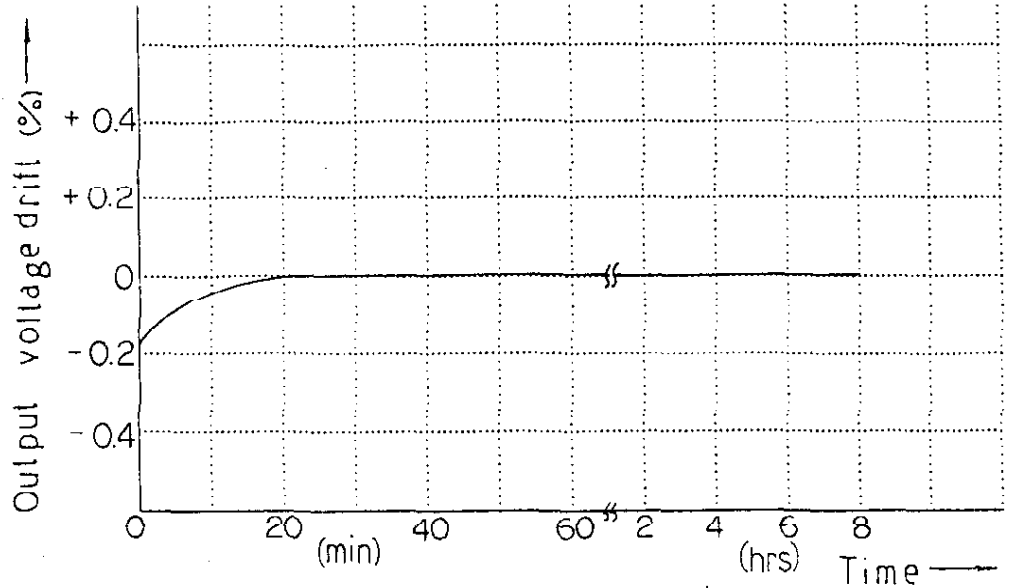

-12V

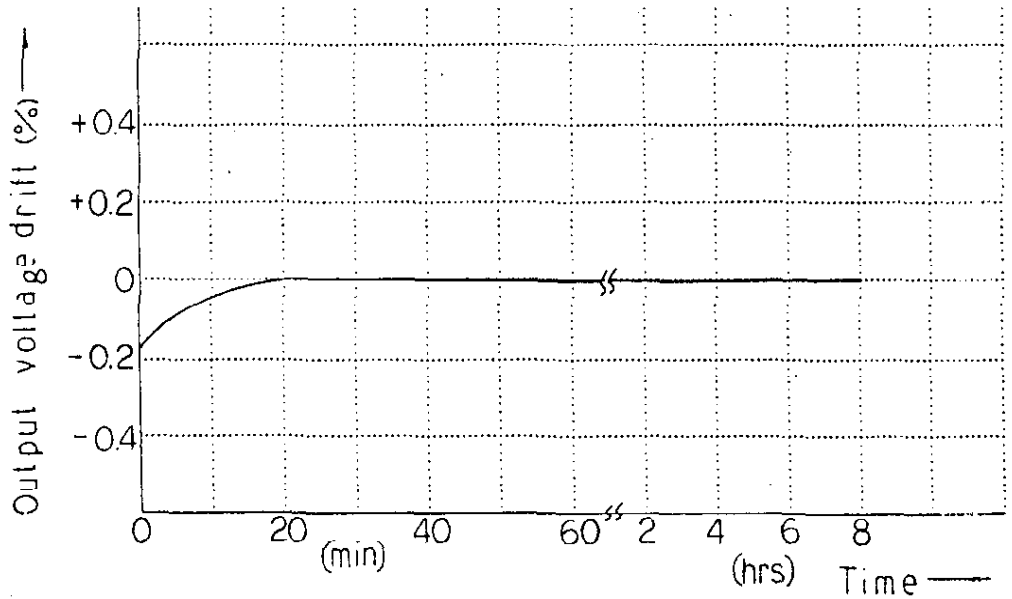

24V

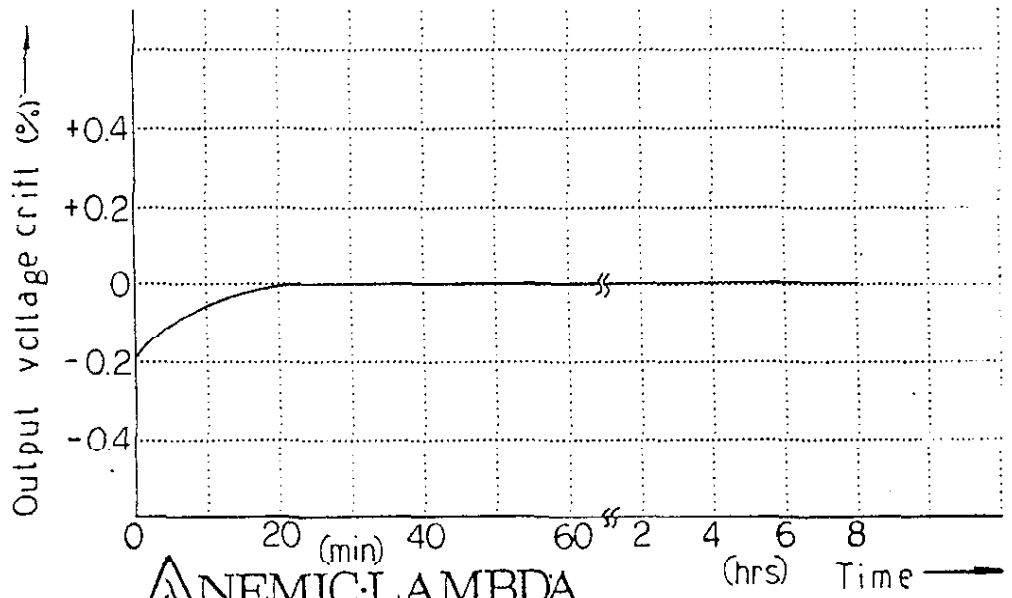

Δ NEMIC·LAMBDA

Warm Up Voltage Drift

KWD15

Condition Vin : AC100V
Iout : 100%
Ta : 25°C

+15V

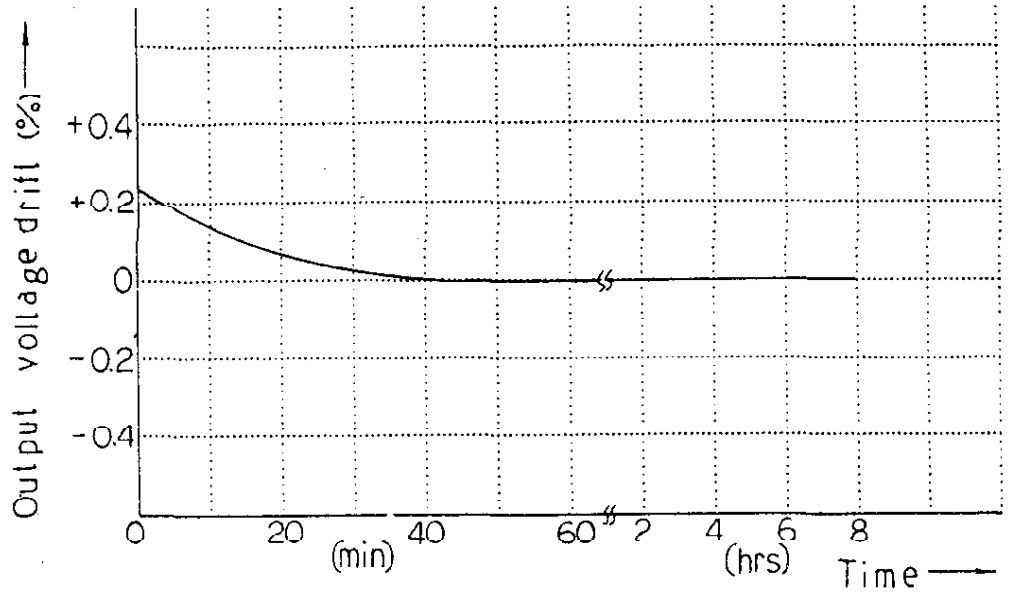

-15V

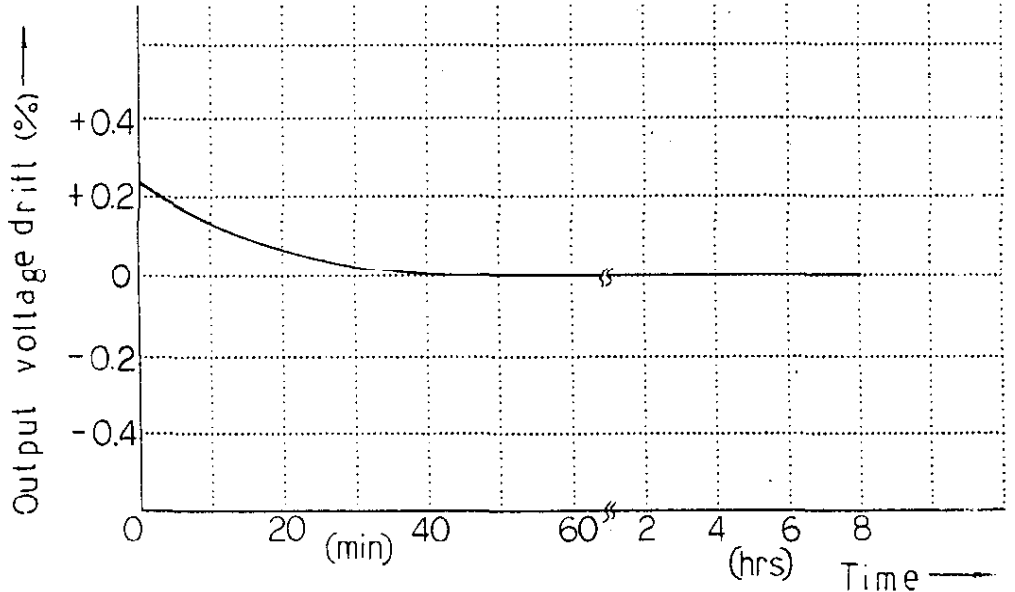

30V

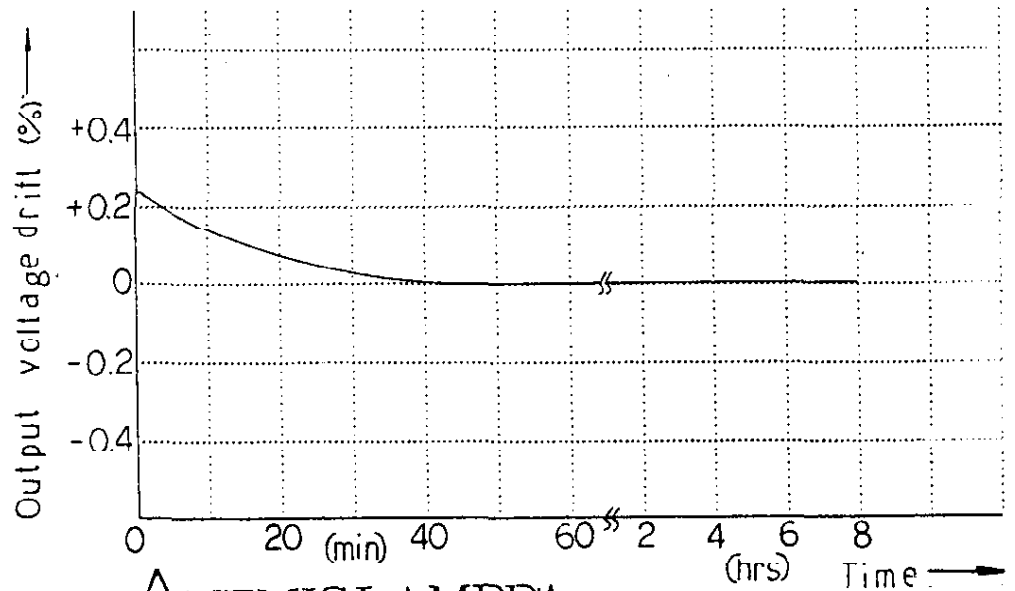

KWD15

O.C.P. Characteristics

Condition Vin : AC 85V ---
: AC100V ———
: AC220V - - -
: AC265V - - -
Ta : 25 °C

24V

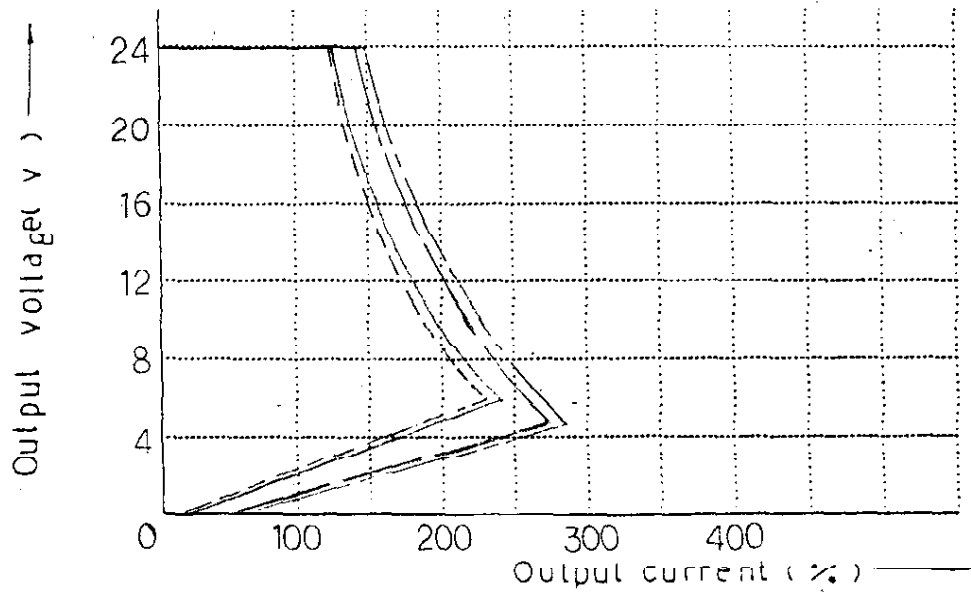

30V

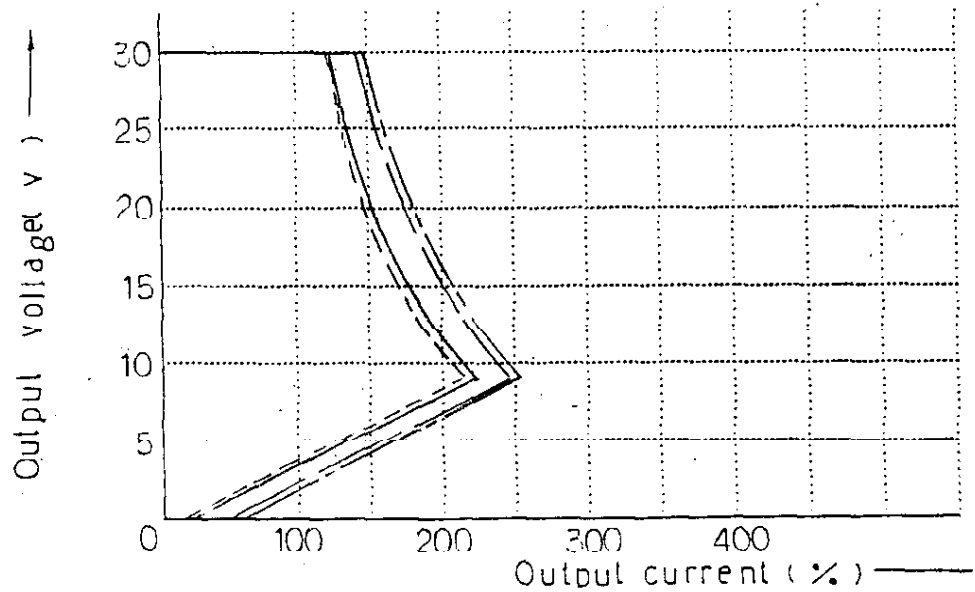

O.C.P. Characteristics

KWD15

Condition Vin : AC100V
Ta : 0°C ———
25°C - - - - -
50°C — · — ·

24V

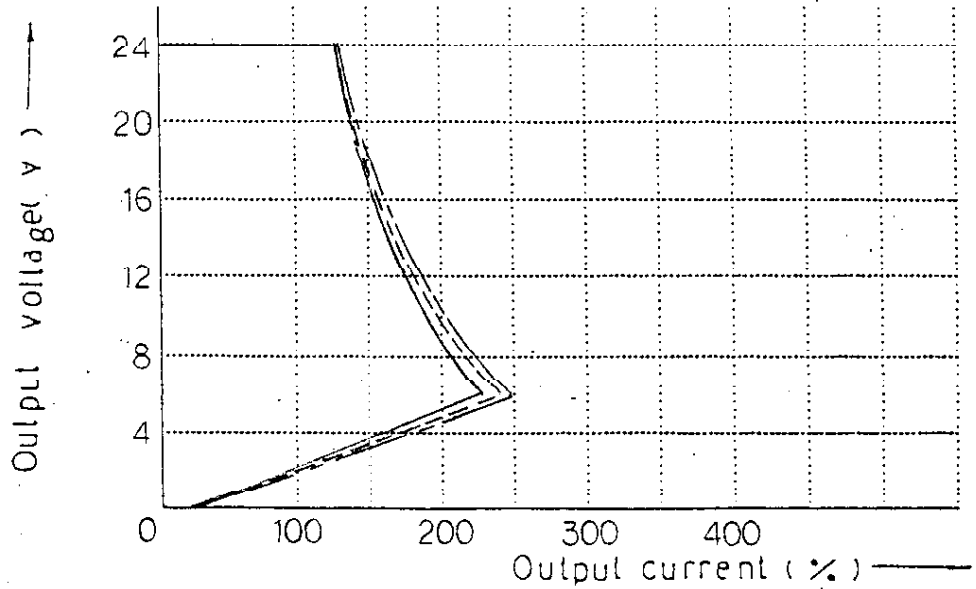

30V

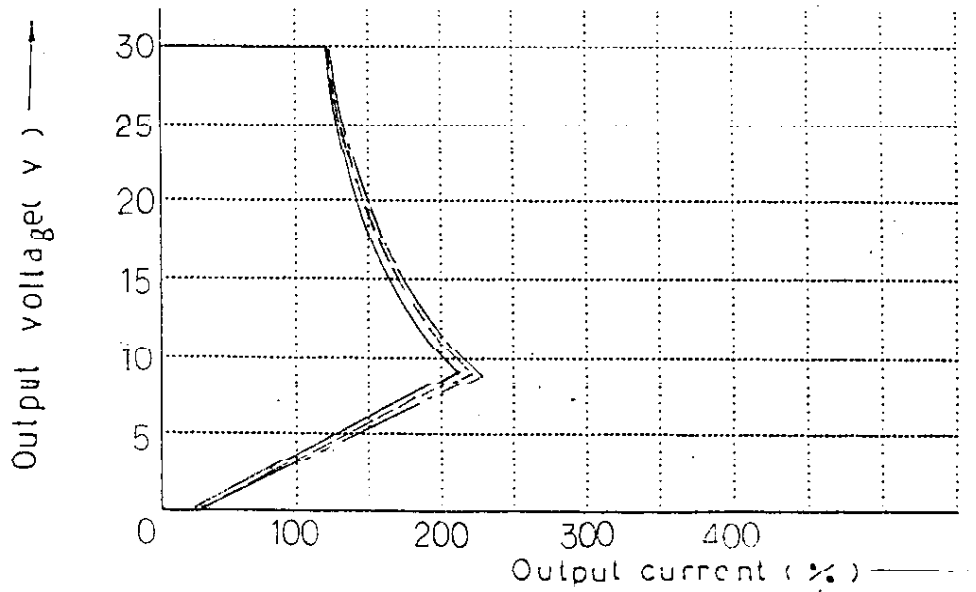

Condition Vin : AC100V
Iout : 0%
Ta : 25°C

-12V

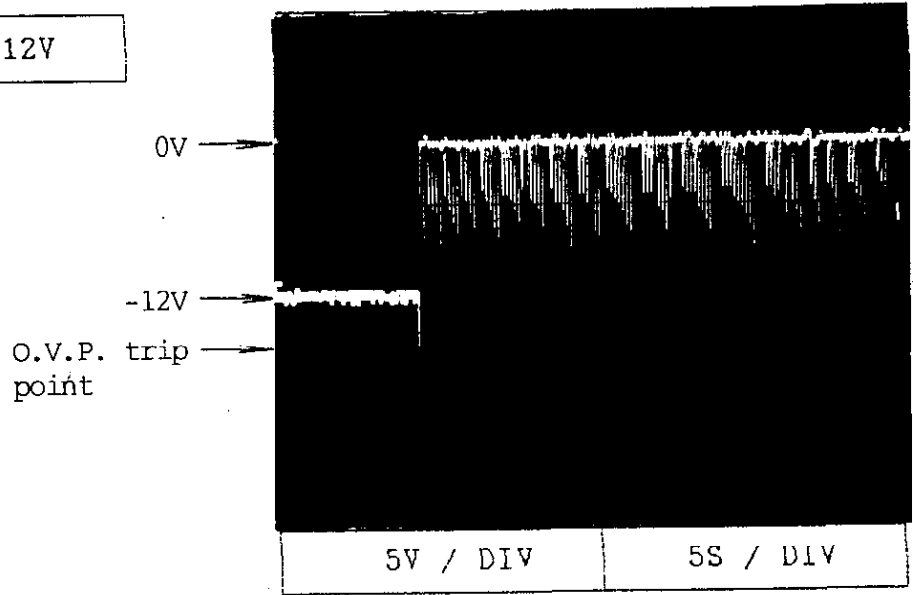

-15V

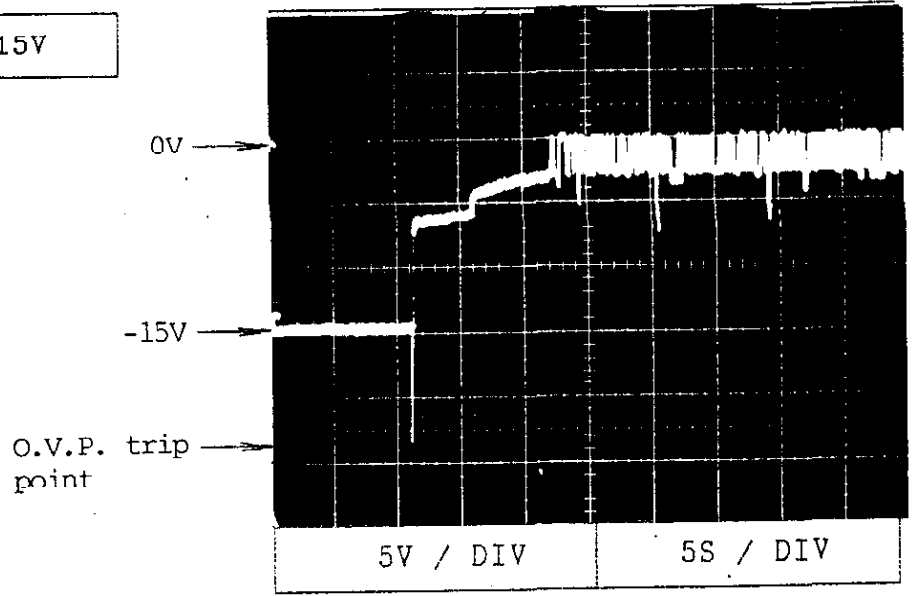

Output Rise Time

KWD15

Condition Vin : AC 85V (A)
 : AC100V (B)
 : AC220V (C)
 : AC265V (D)
 Iout: 0 %
 Ta : 25°C

+12V

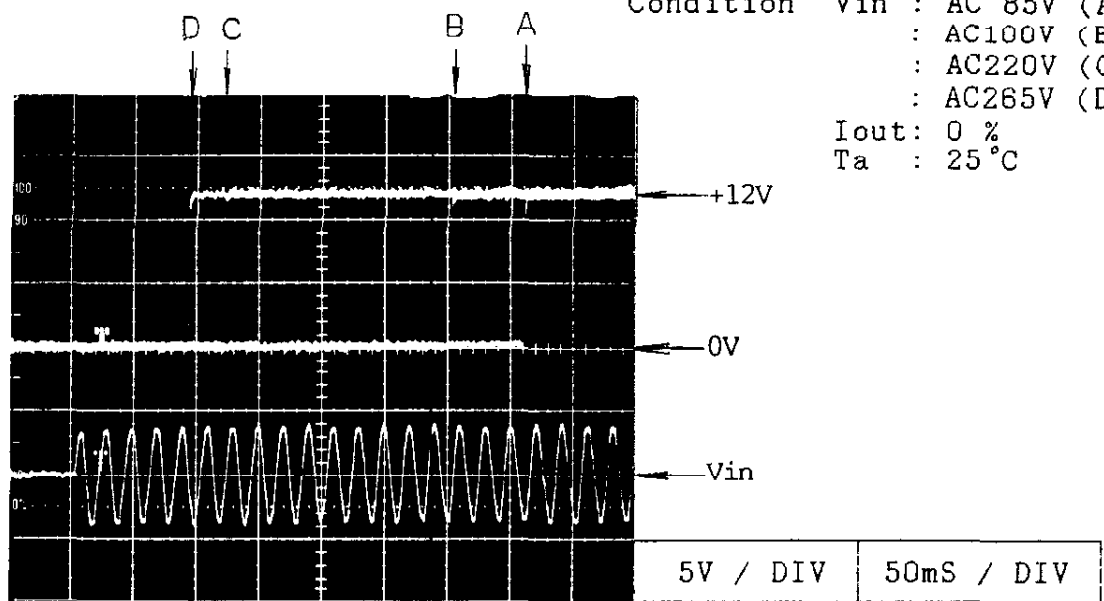

-12V

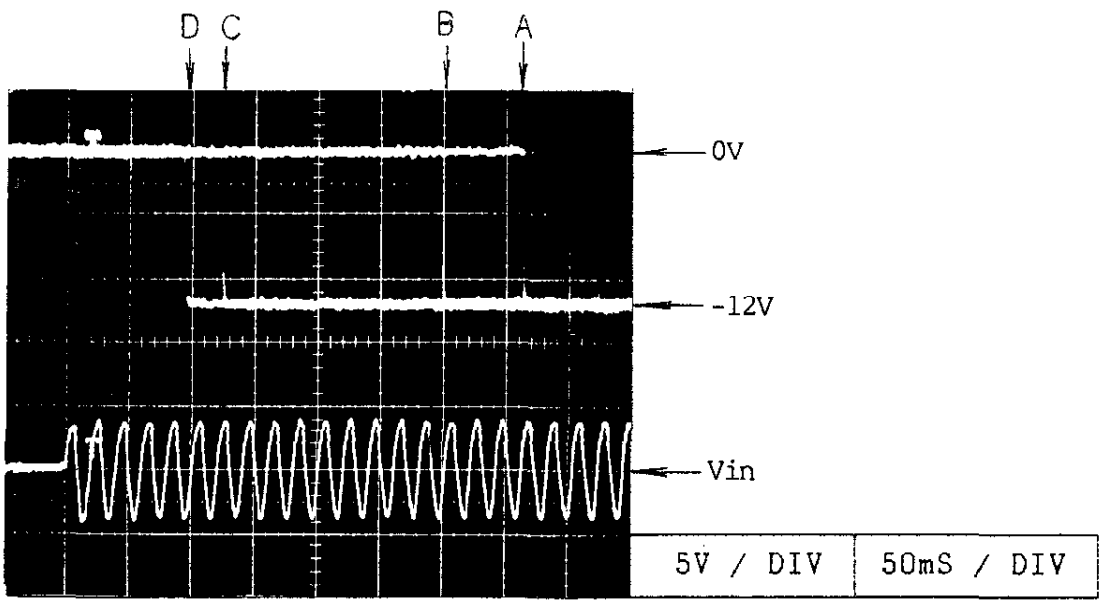

24V

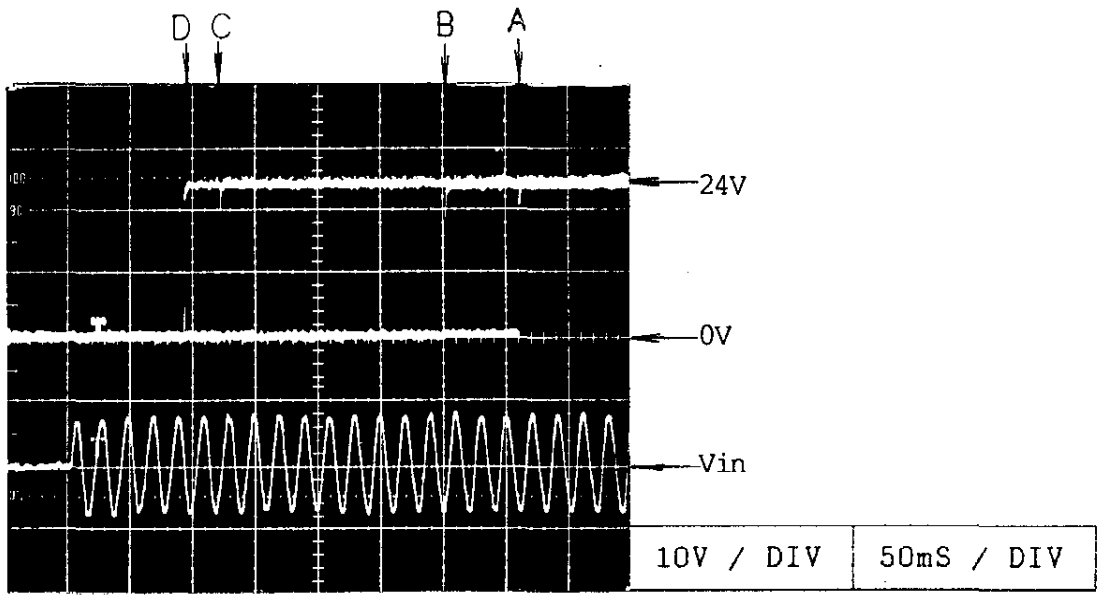

Output Rise Time

KWD15

Condition Vin : AC 85V (A)
 : AC100V (B)
 : AC220V (C)
 : AC265V (D)
 Iout : 100 %
 Ta : 25 °C

+12V

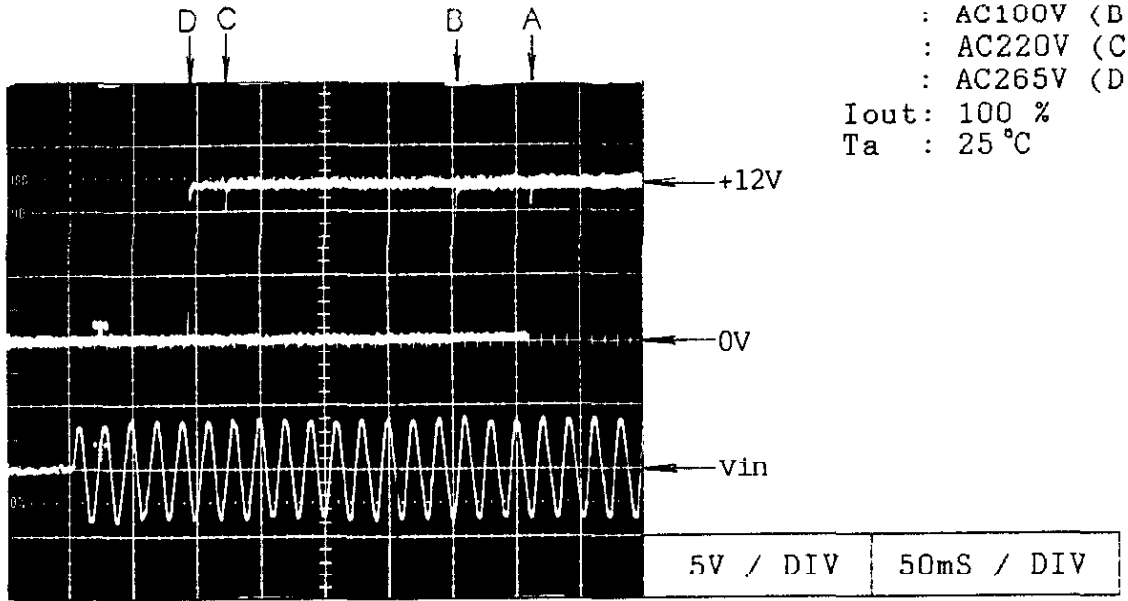

-12V

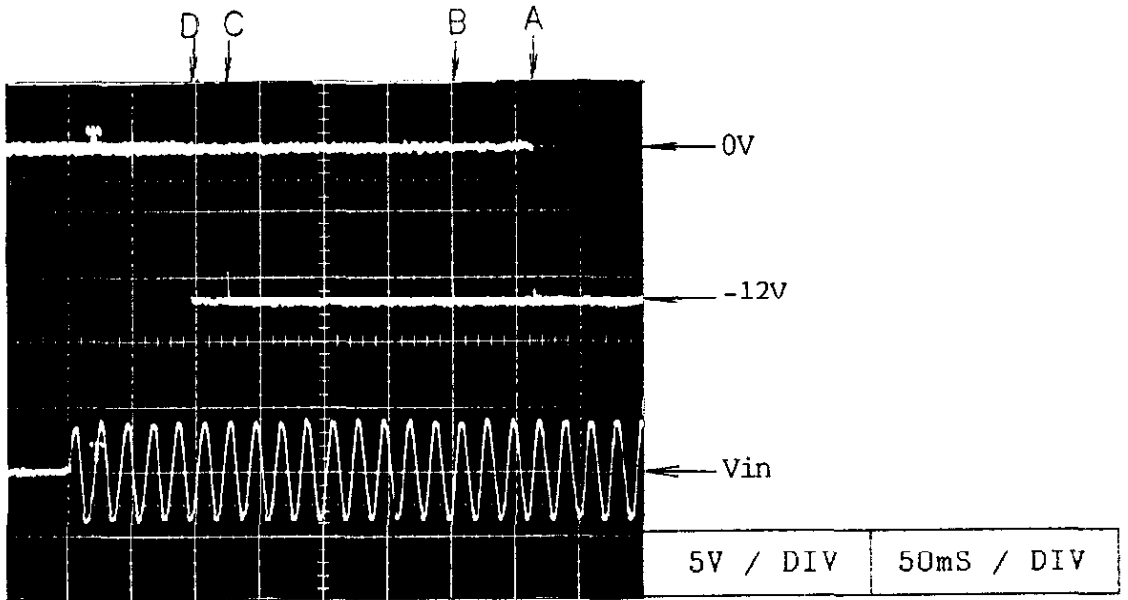

24V

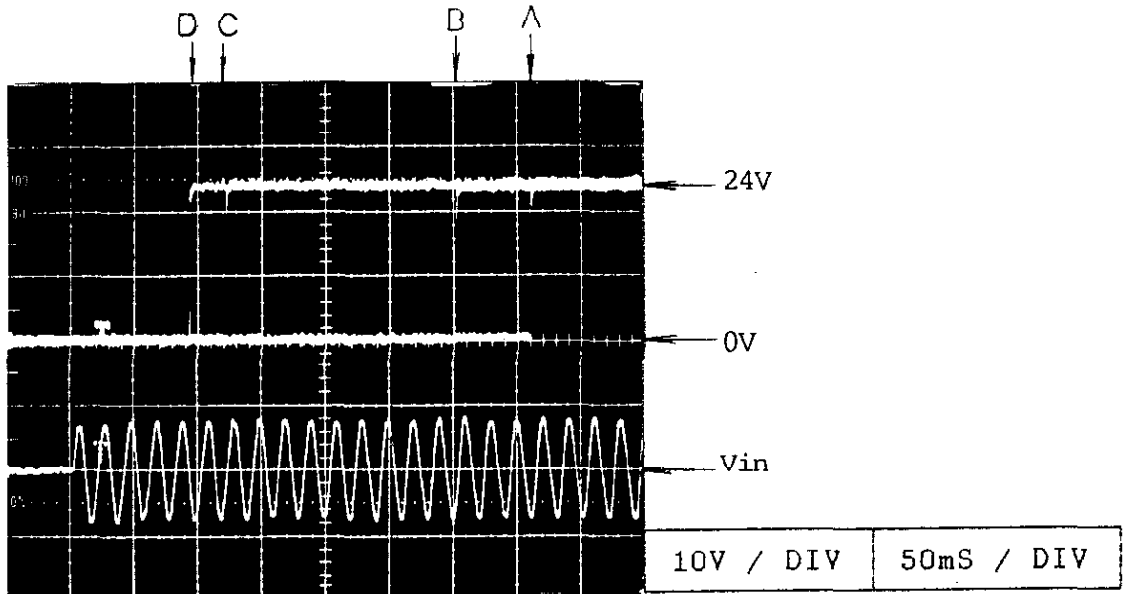

Output Rise Time

KWD15

Condition Vin : AC 85V (A)
 : AC100V (B)
 : AC220V (C)
 : AC265V (D)
 Iout: 0 %
 Ta : 25 °C

+15V

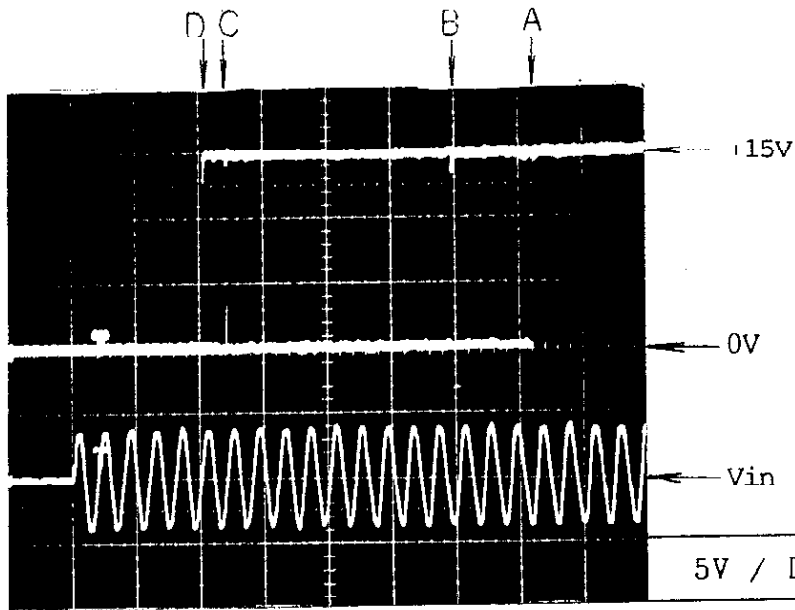

-15V

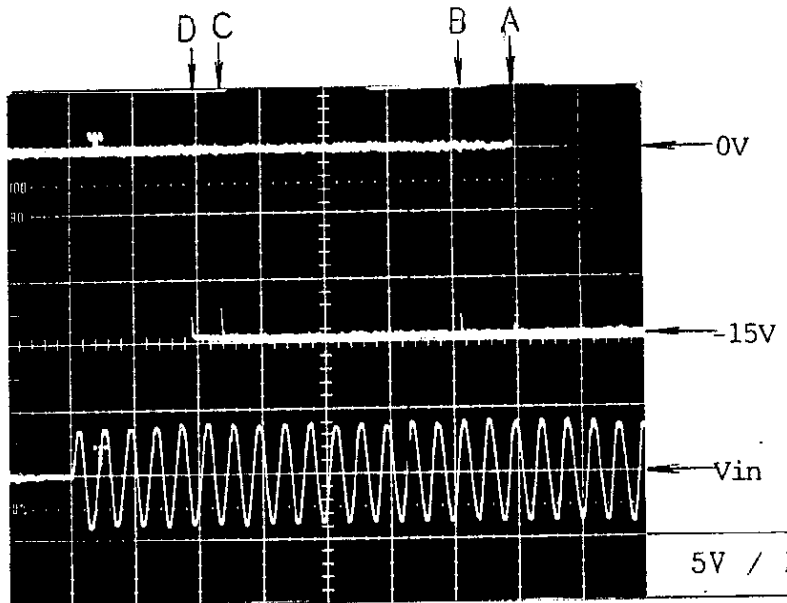

30V

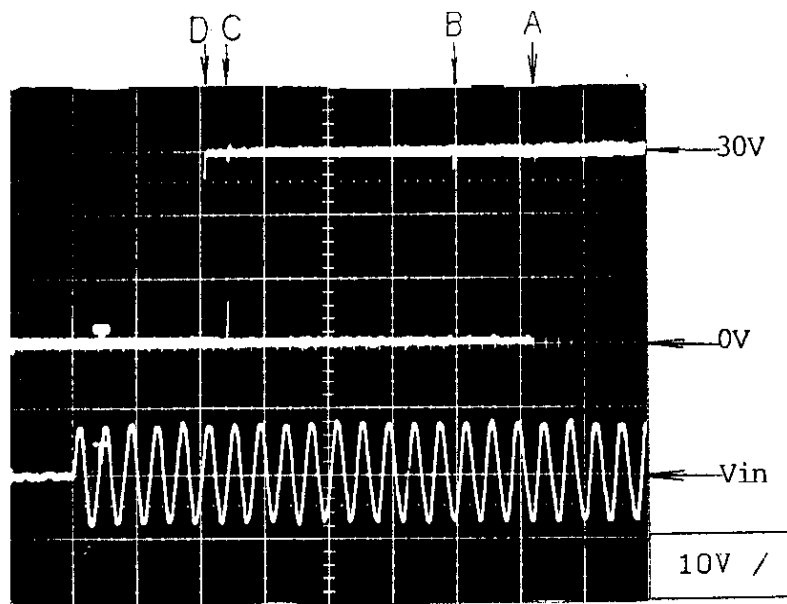

Output Rise Time

KWD15

Condition Vin : AC 85V (A)
 : AC100V (B)
 : AC220V (C)
 : AC265V (D)
 Iout : 100 %
 Ta : 25 °C

+15V

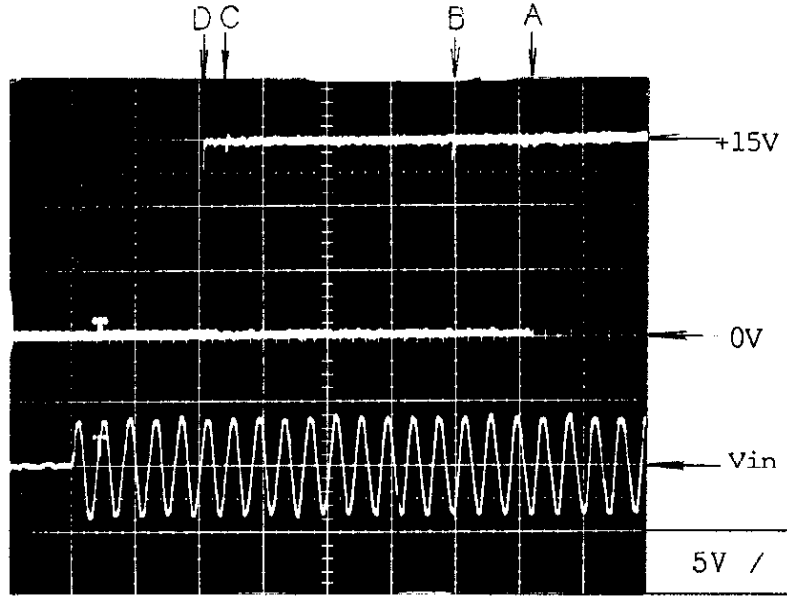

-15V

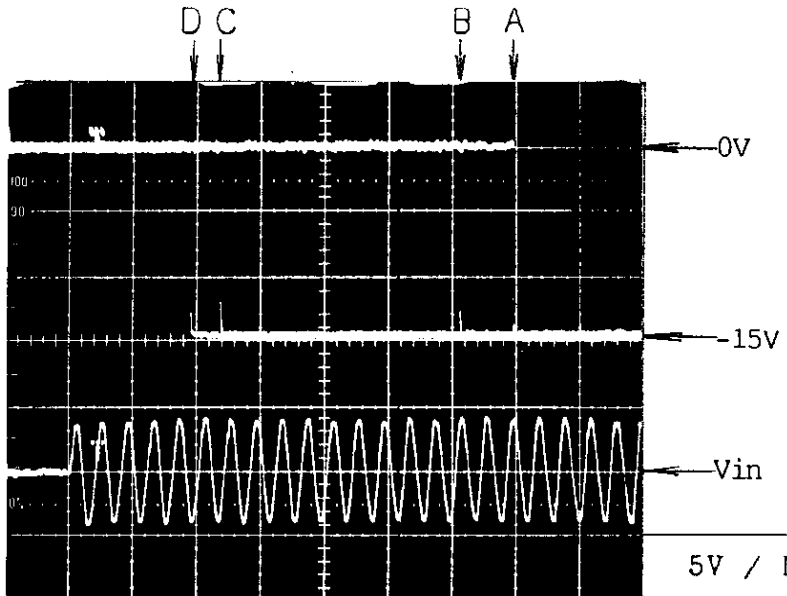

30V

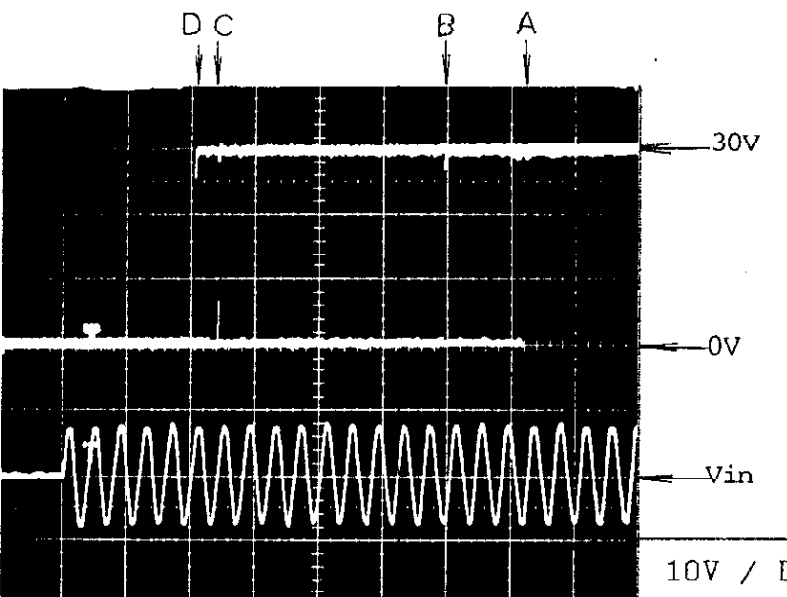

Output Fall Time

KWD15

Condition Vin : AC 85V (A)
 : AC100V (B)
 : AC220V (C)
 : AC265V (D)

Ta : 25°C

+12V

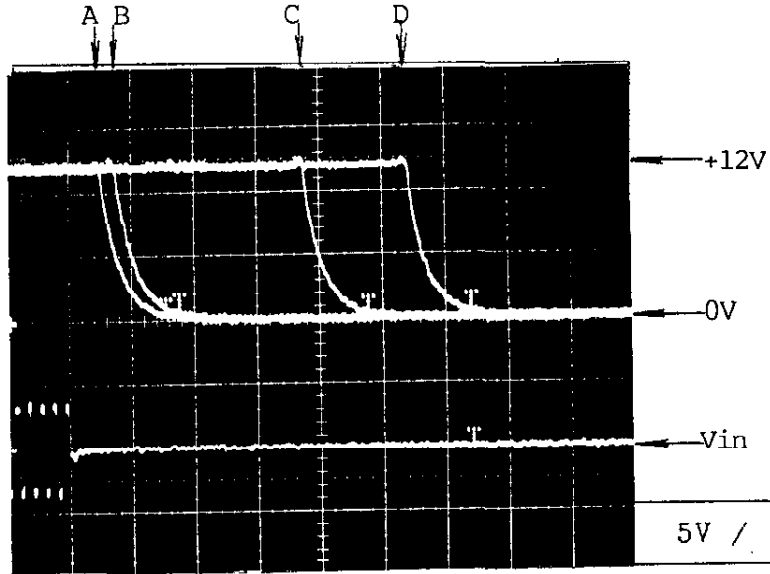

Io(CH1):0%
 Io(CH2):100%

-12V

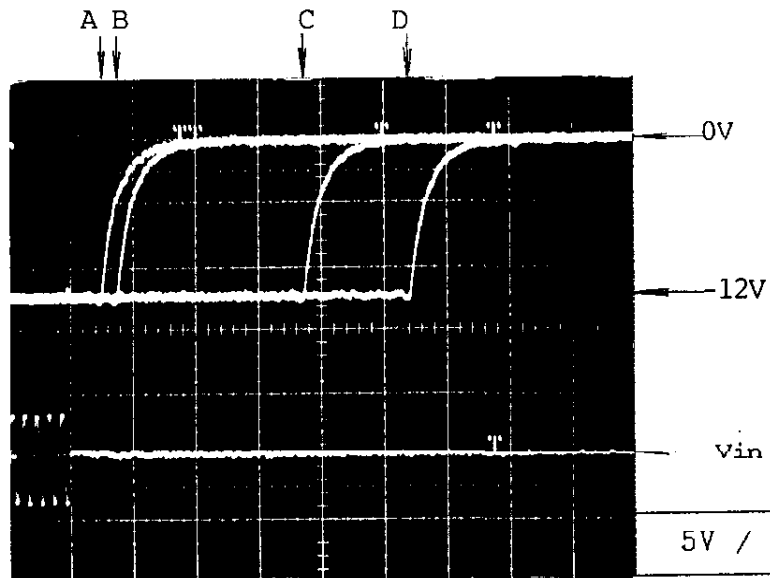

Io(CH1):100%
 Io(CH2):0%

24V

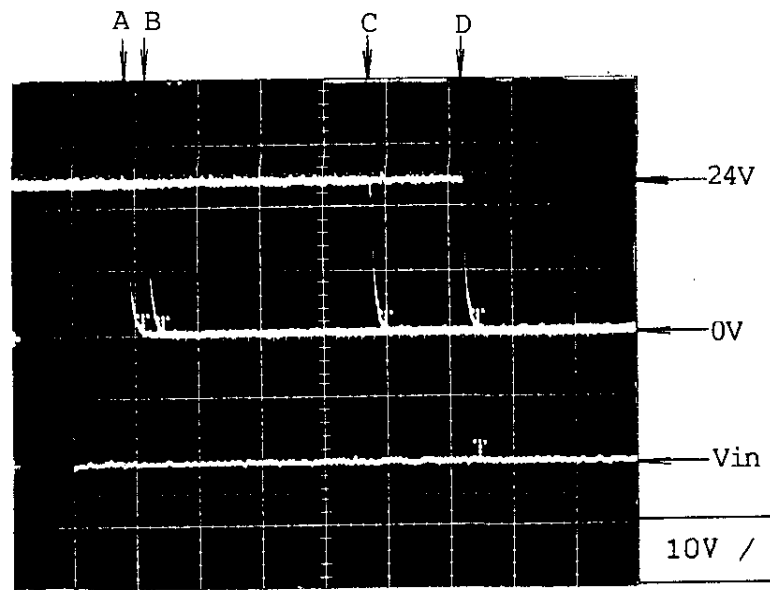

Io : 0%

Vin turn off

Output Fall Time

KWD15

Condition Vin : AC 85V (A)
 : AC100V (B)
 : AC220V (C)
 : AC265V (D)
 I_{out} : 100 %
 T_a : 25 °C

+12V

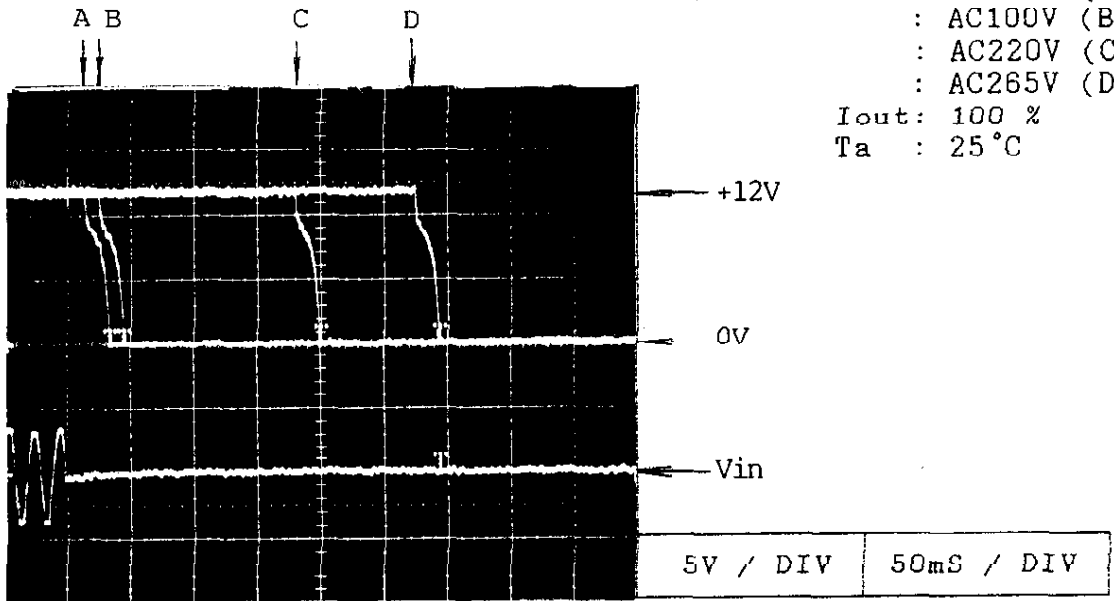

-12V

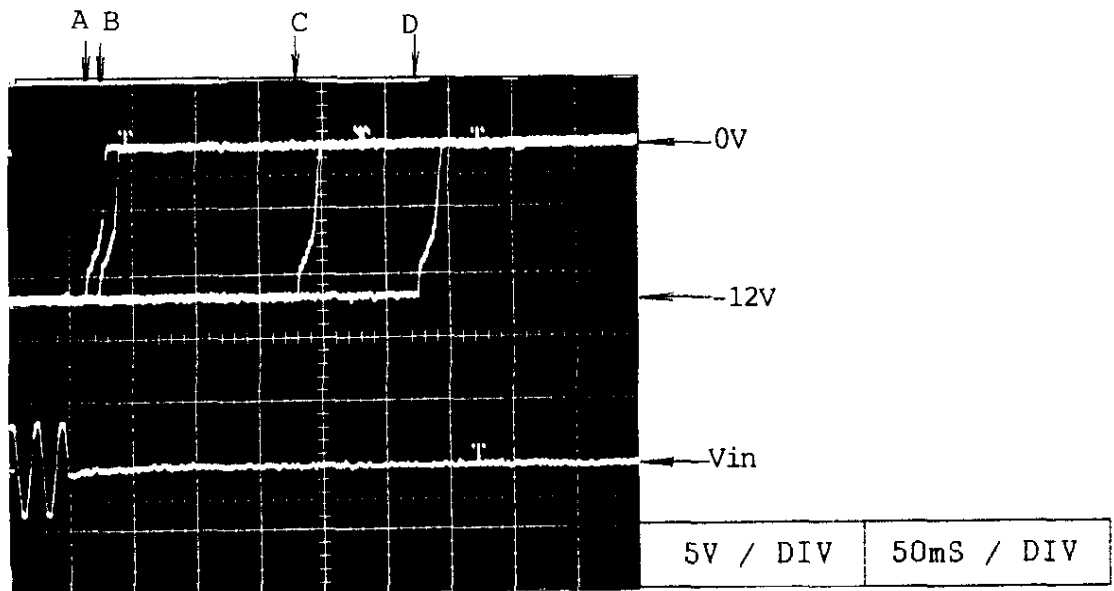

24V

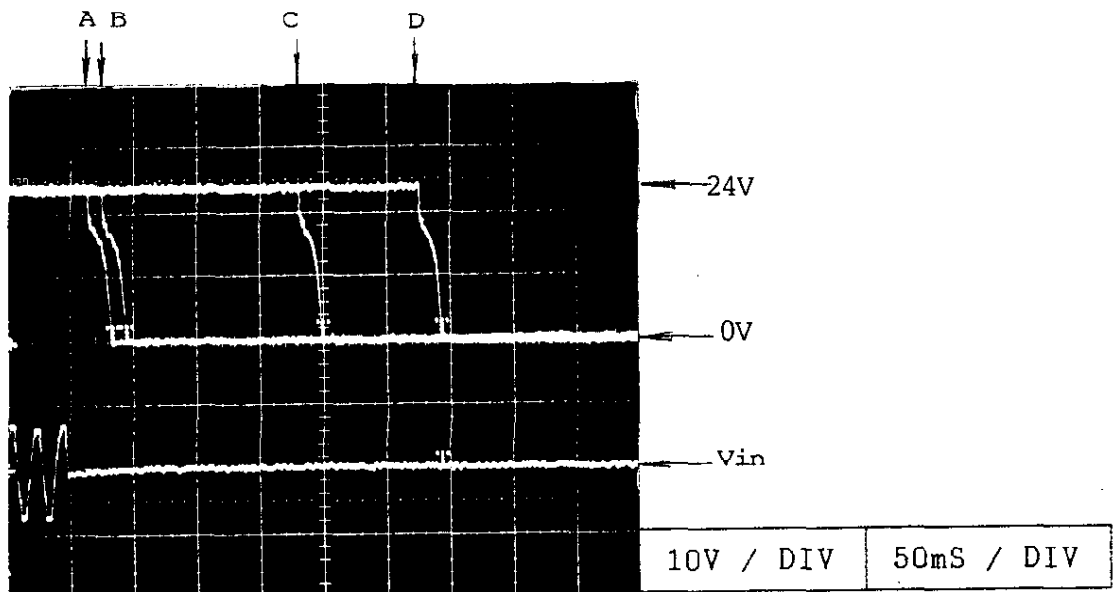

Output Fall Time

KWD15

Condition Vin : AC 85V (A)
 : AC100V (B)
 : AC220V (C)
 : AC265V (D)

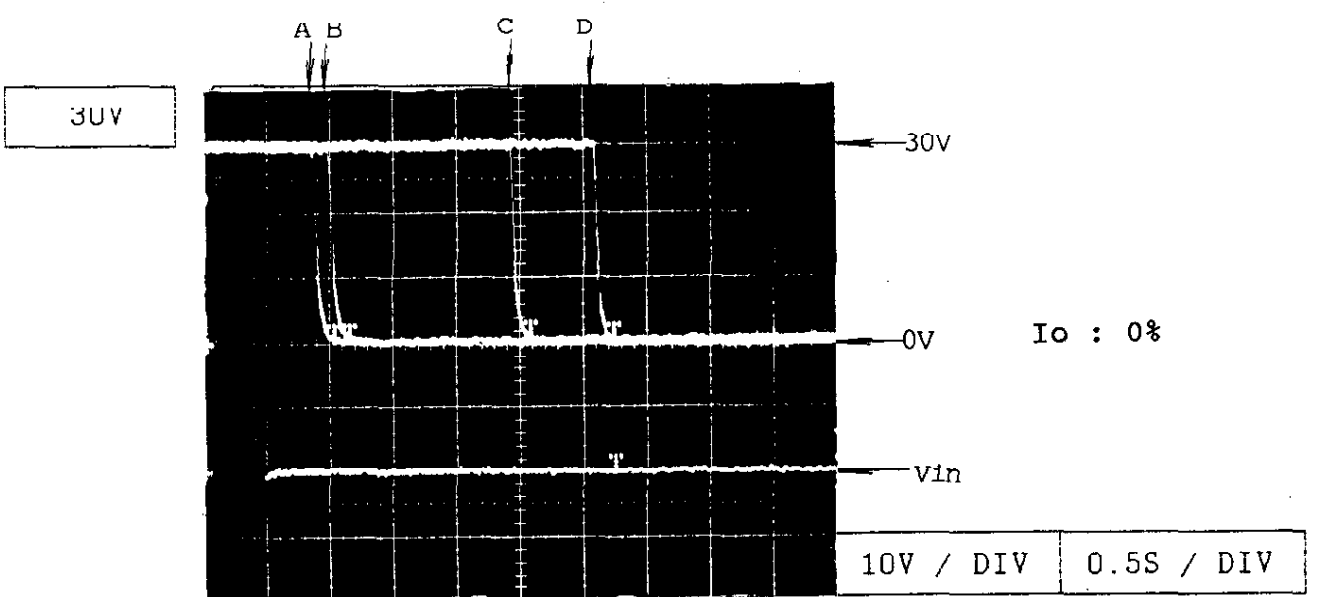
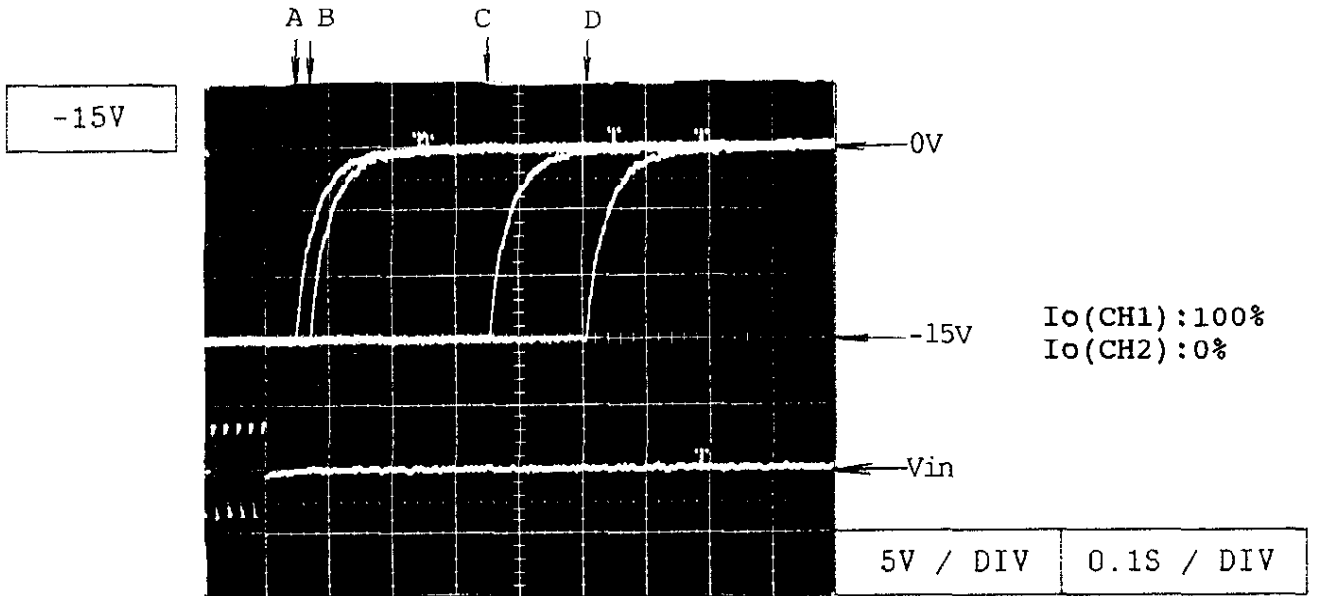
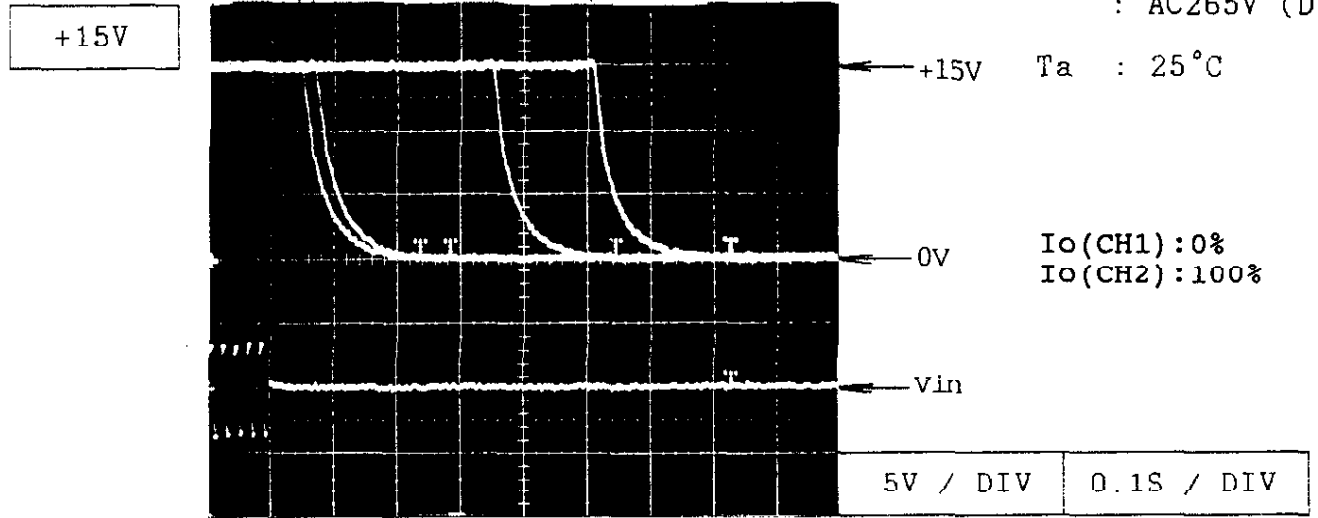

Vin turn off

Output Fall Time

KWD15

Condition Vin : AC 85V (A)
 : AC100V (B)
 : AC220V (C)
 : AC265V (D)
 Iout: 100 %
 Ta : 25 °C

+15V

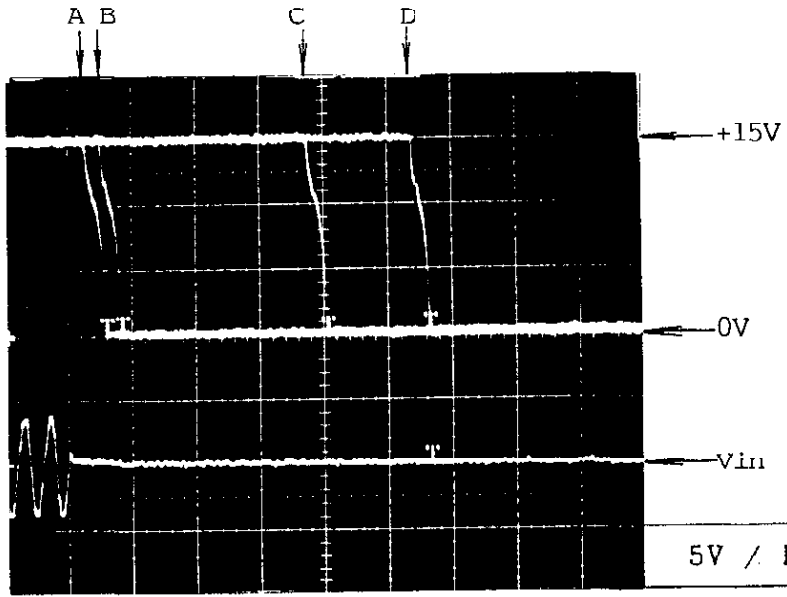

-15V

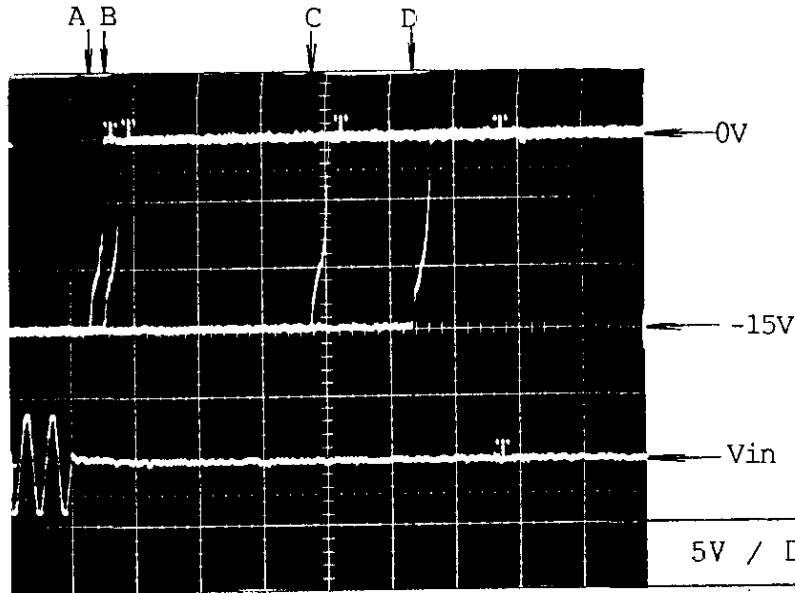

30V

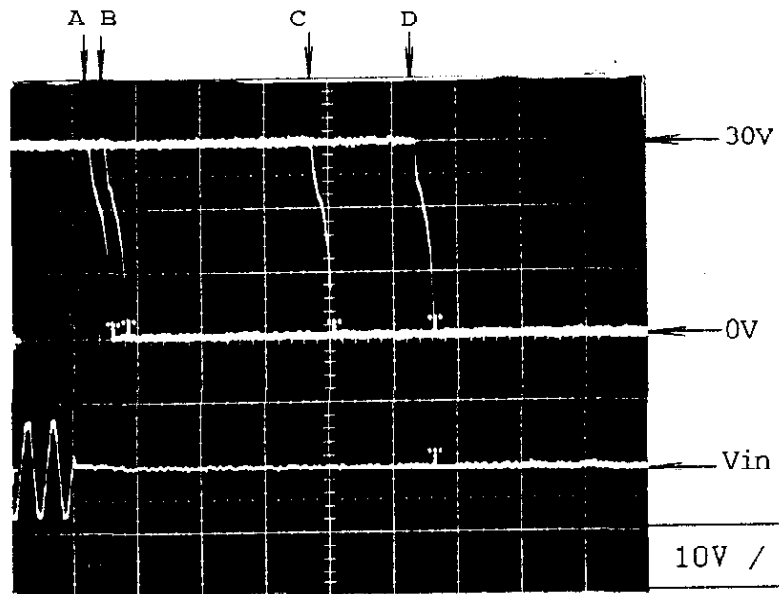

Hold Up Time

KWD15

Condition Vin : AC 85V ———
AC100V - - - -
AC220V - - - -
AC265V - - - -
Ta : 25°C

24V

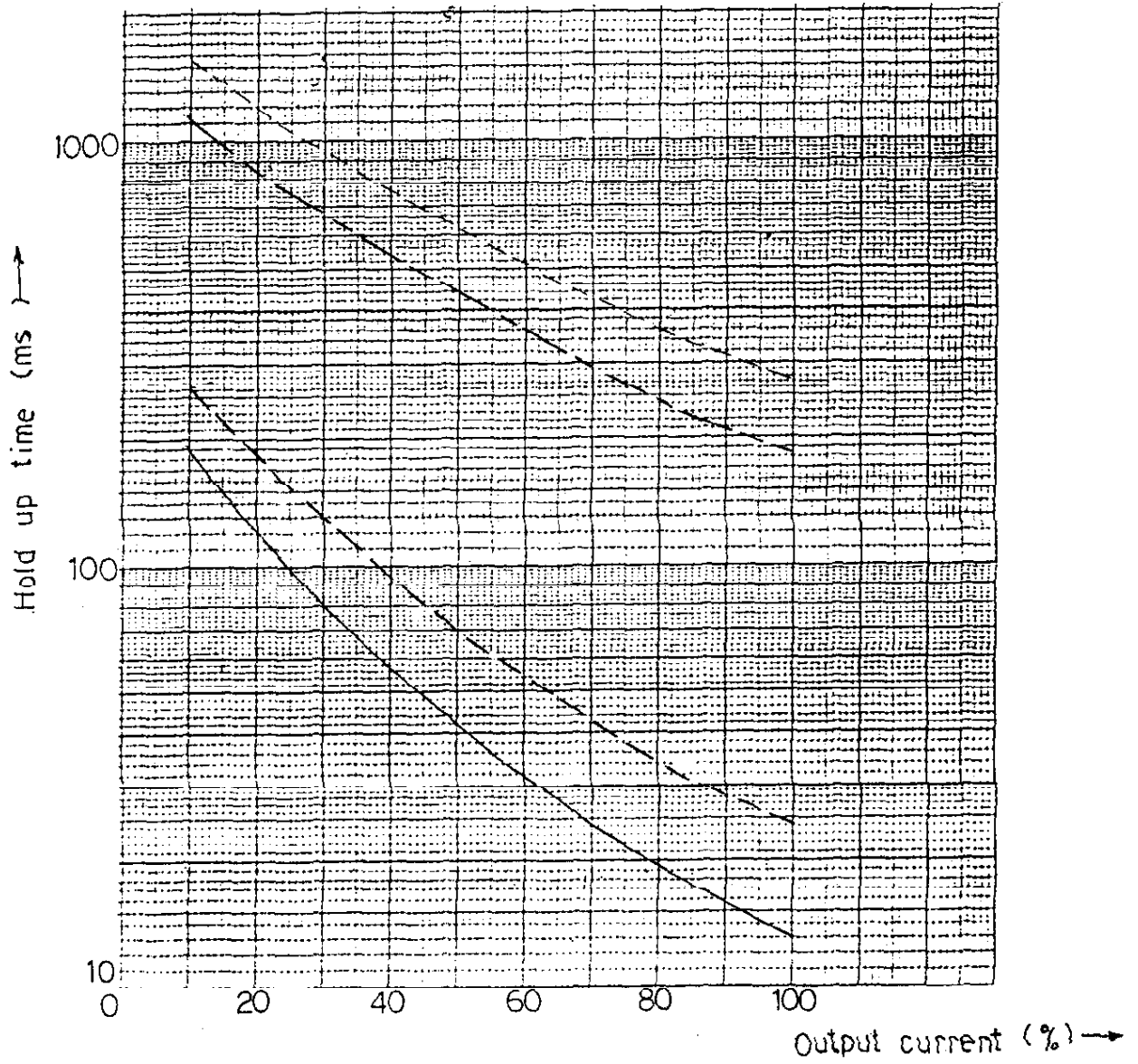

Hold Up Time

KWD15

Condition Vin : AC 85V ———
AC100V - - -
AC220V - · - ·
AC265V - - - -
Ta : 25 °C

30V

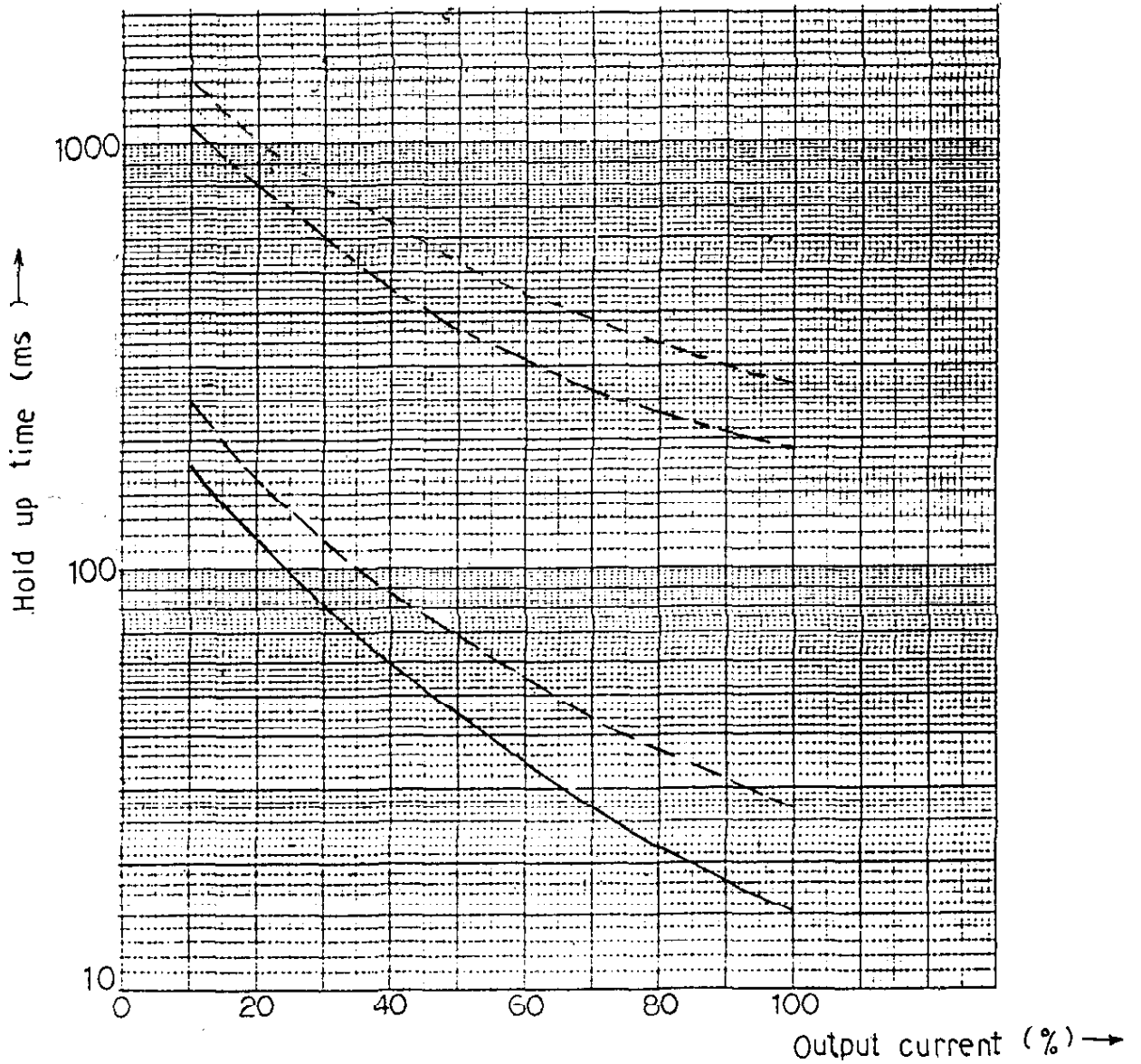

Dynamic Line Response

KWD15

Condition Iout: 100 %
Ta : 25 °C

±12V

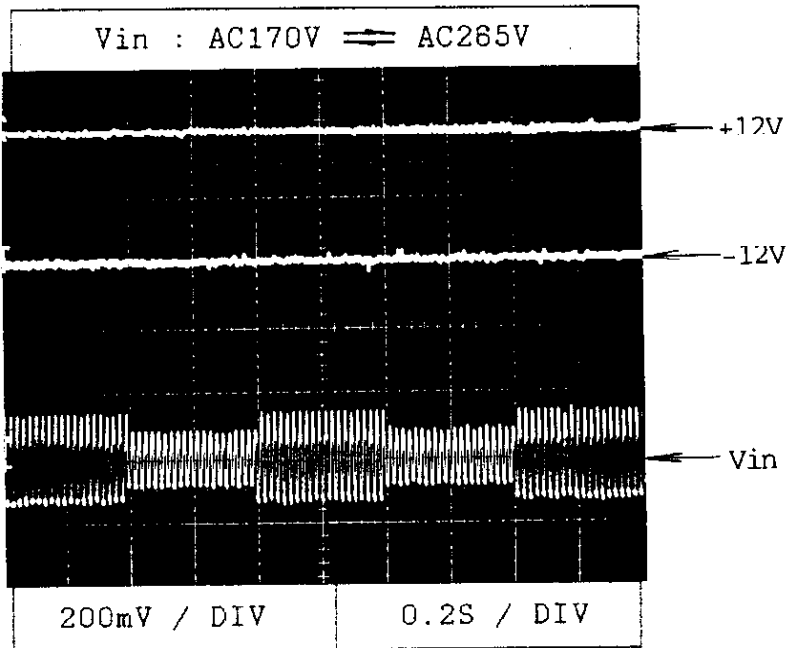
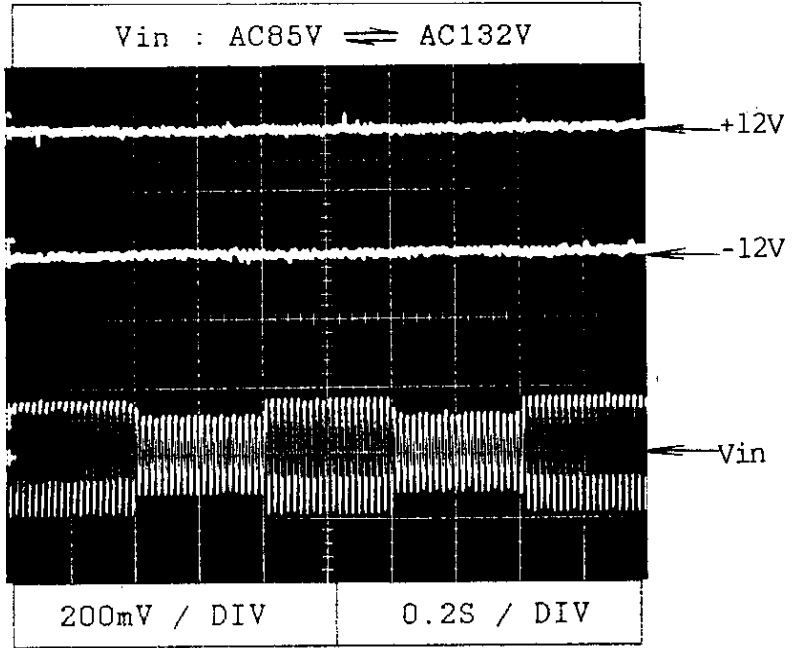

Dynamic Line Response

KWD15

Condition Iout: 100 %
Ta : 25 ^ C

24V

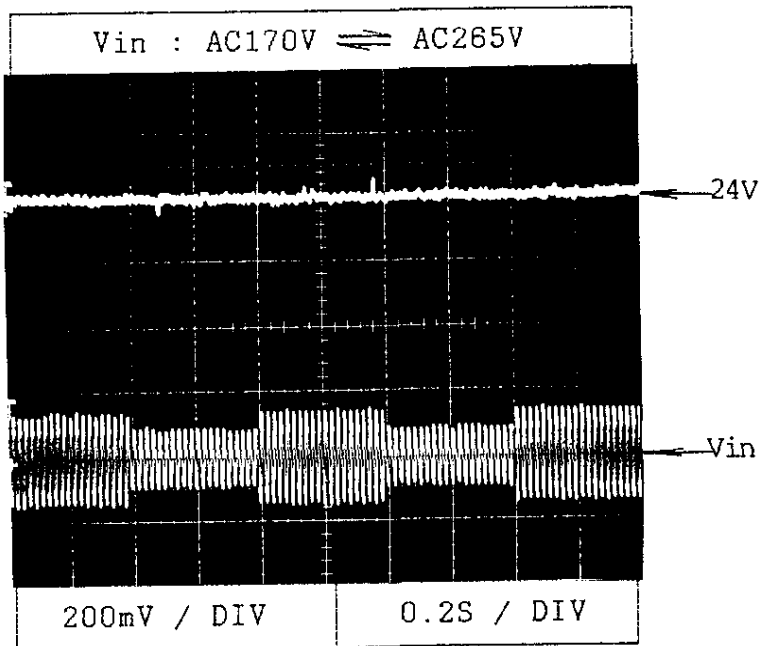
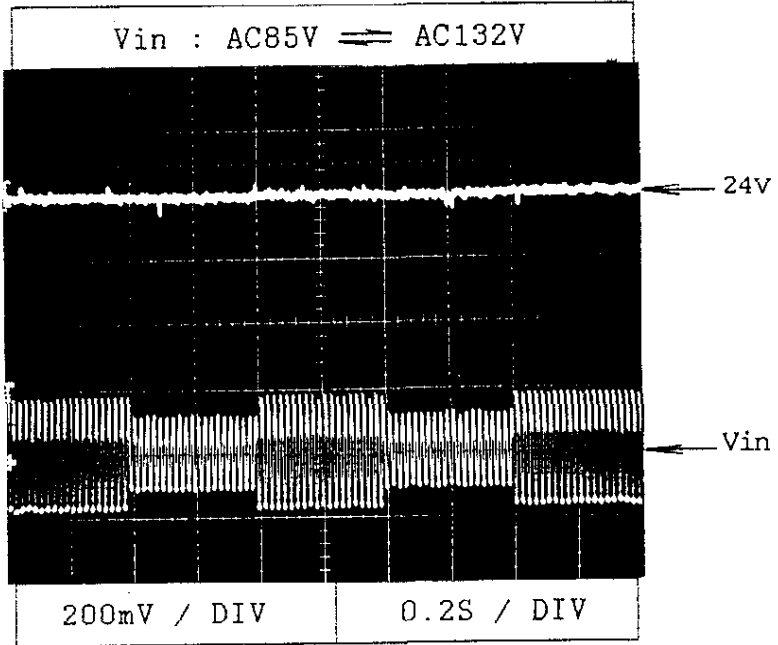

Dynamic Line Response

KWD15

Condition Iout: 100 %
Ta : 25 °C

±15V

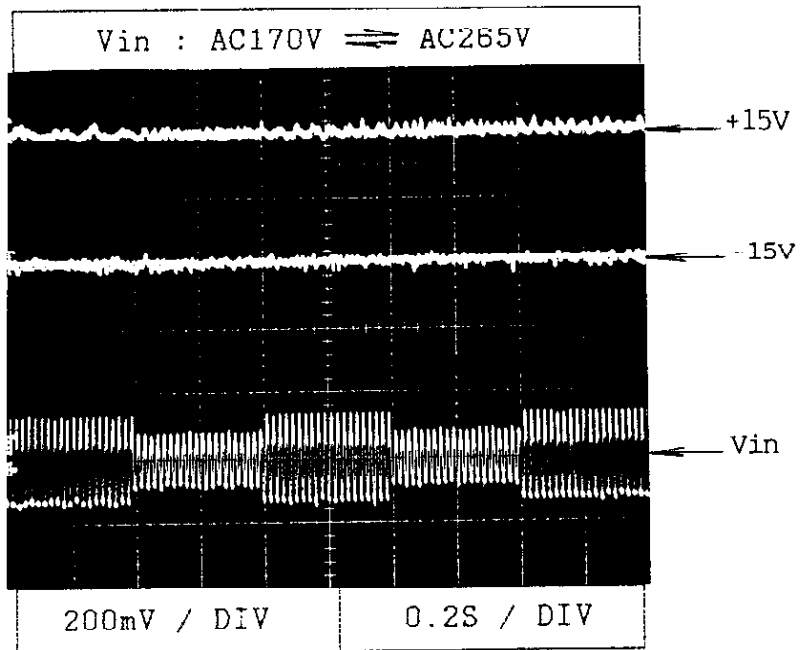
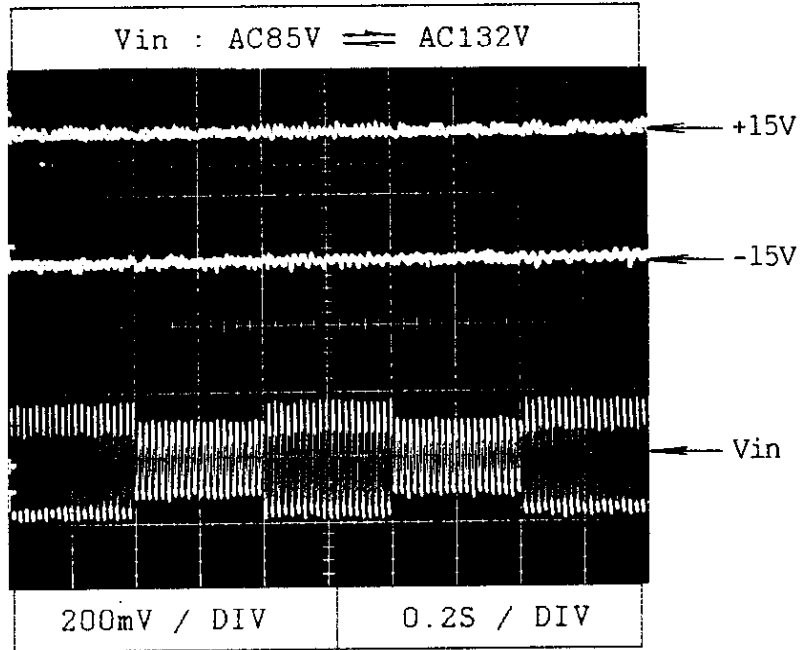

Dynamic Line Response

KWD15

Condition Iout: 100 %
Ta : 25 ° C

30V

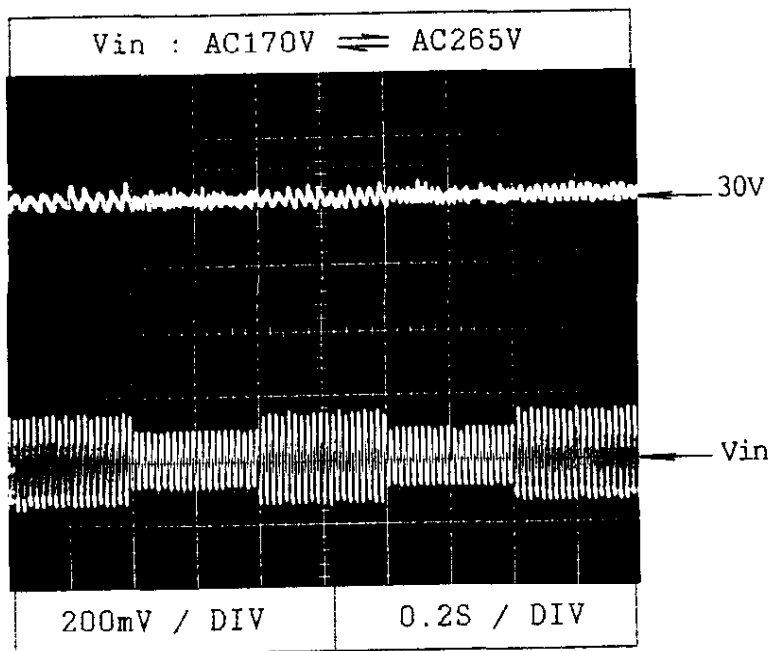
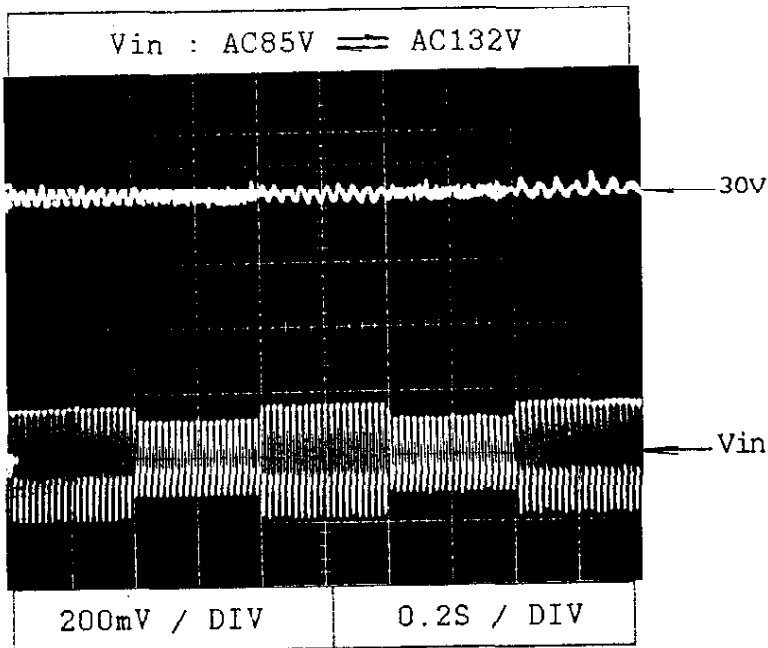

Condition Vin : AC100V
 Iout: 100%
 Ta : 25°C

±12V

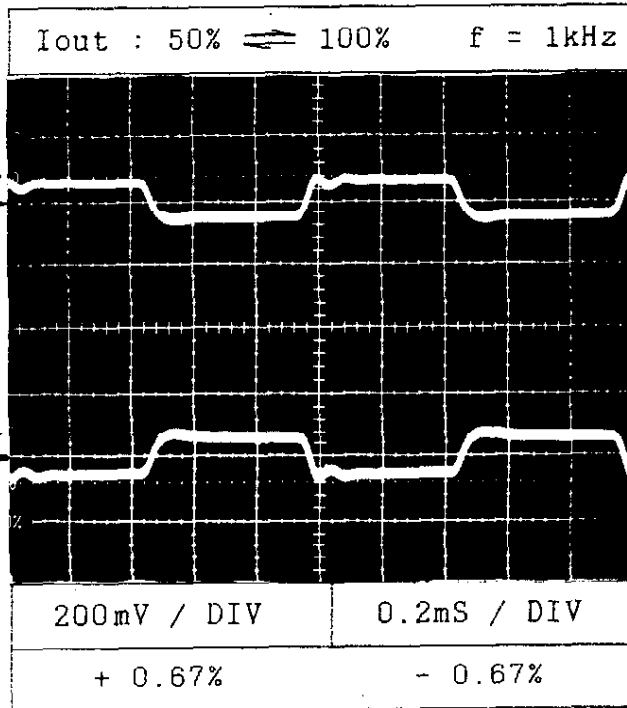
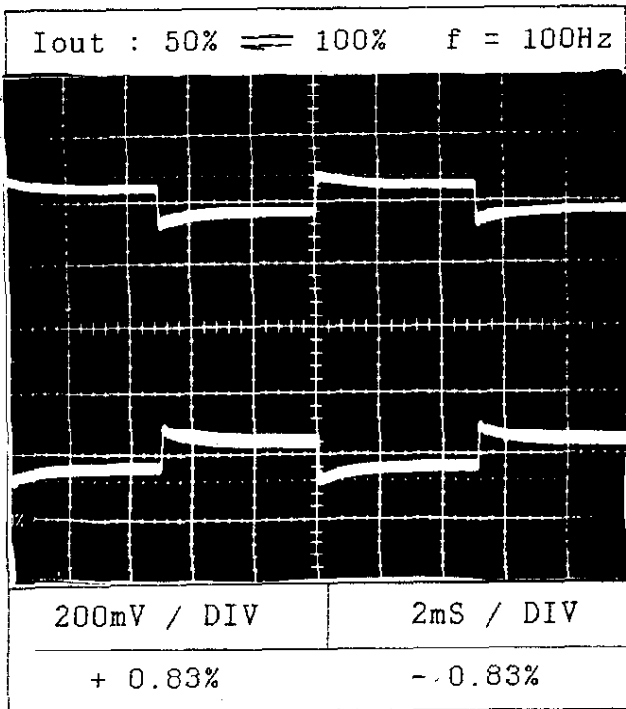
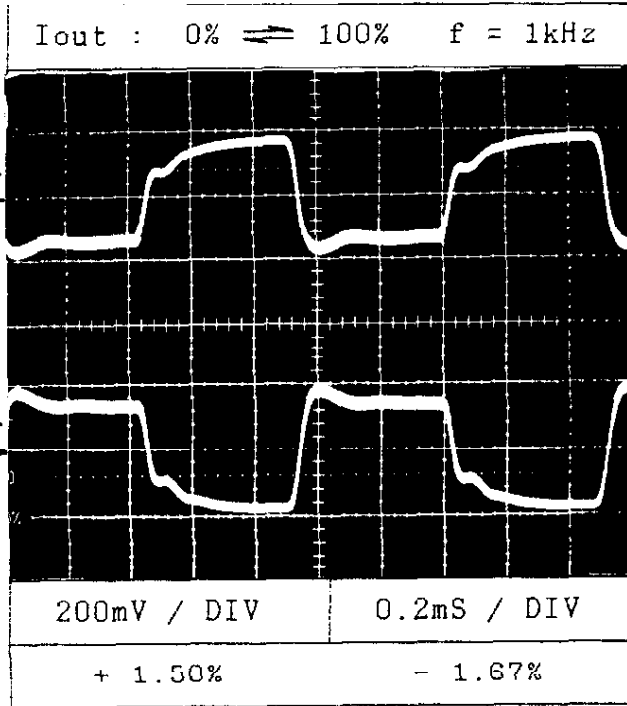
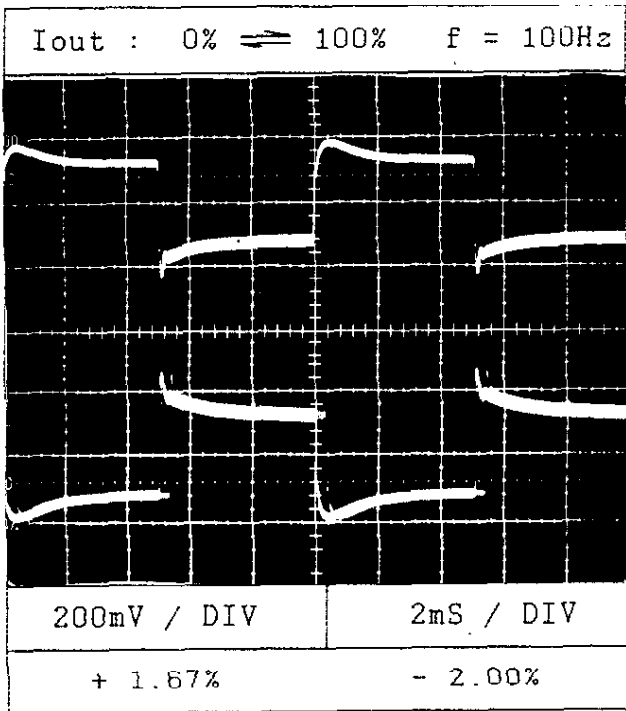

NOTE:

- When performing dynamic load for CH1:
- (1) Only the output waveform of this channel is taken.
 - (2) CH2 is at 100%

NOTE:

- When performing dynamic load for CH2:
- (1) Only the output waveform of this channel is taken.
 - (2) CH1 is at 100%

Dynamic Load Response

KWD15

Condition Vin : AC220V
 Iout: 100%
 Ta : 25°C

±12V

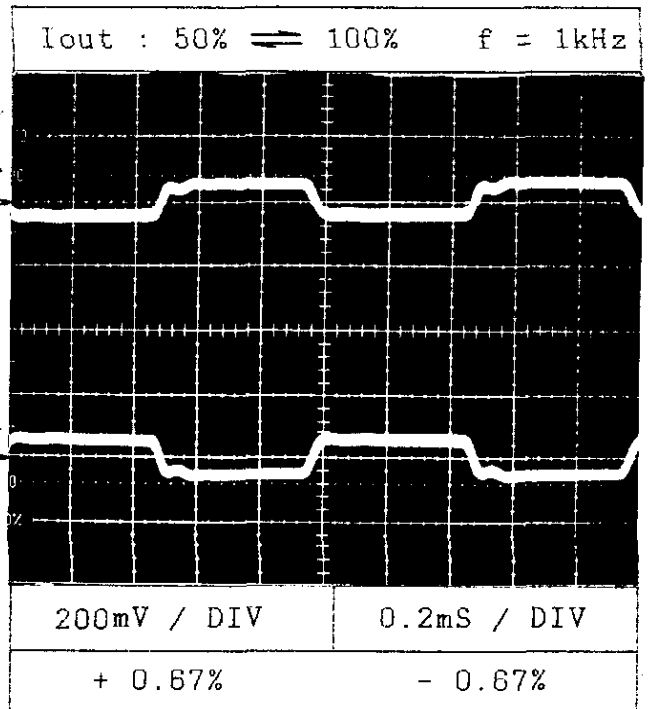
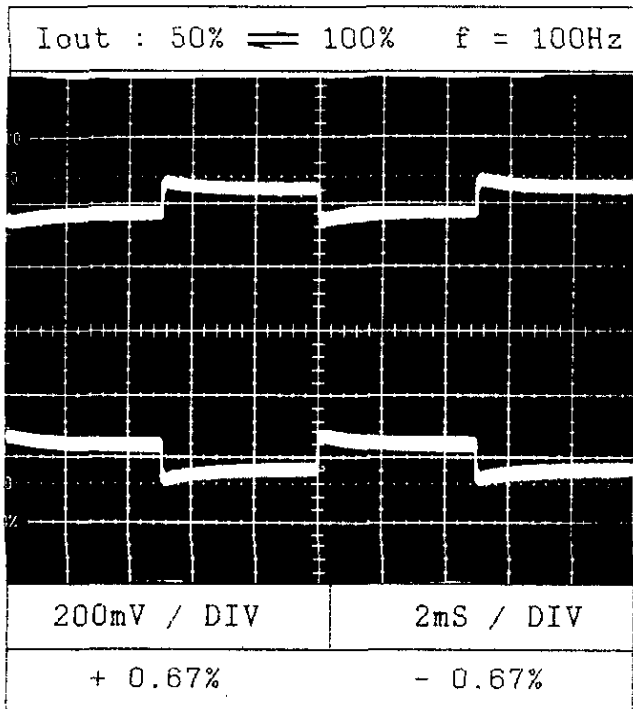
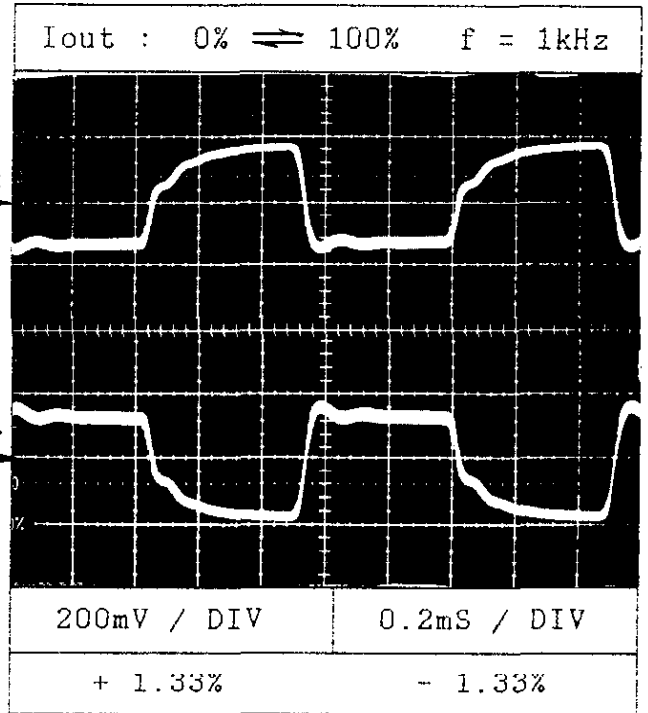
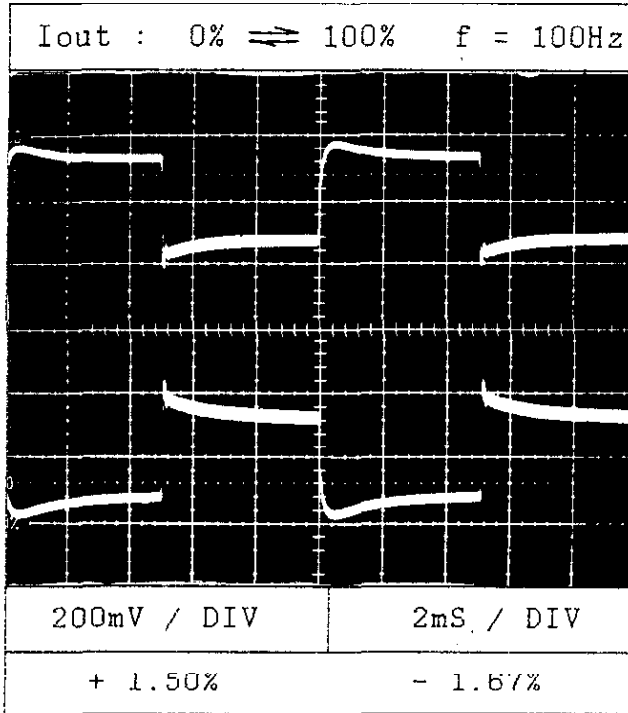

NOTE:

- When performing dynamic load for CH1:
- (1) Only the output waveform of this channel is taken.
 - (2) CH2 is at 100%

NOTE:

- When performing dynamic load for CH2:
- (1) Only the output waveform of this channel is taken.
 - (2) CH1 is at 100%

Dynamic Load Response

KWD15

Condition Vin : AC100V
Ta : 25°C

24V

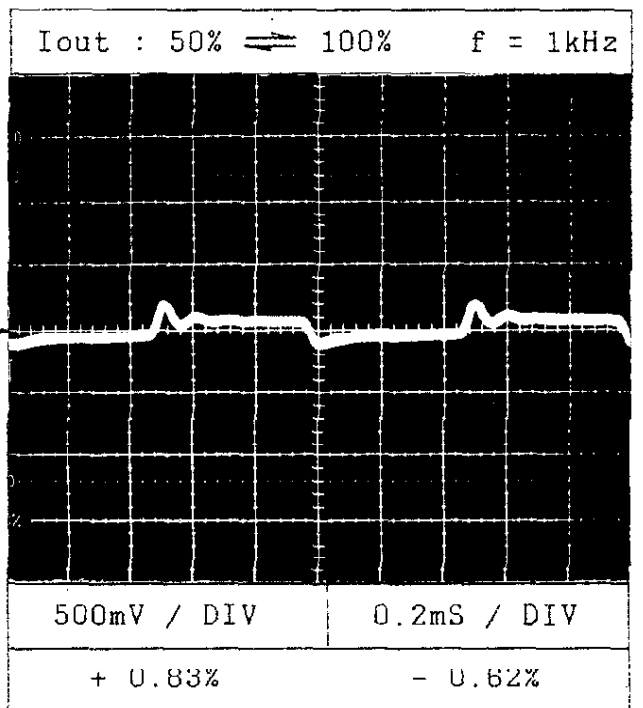
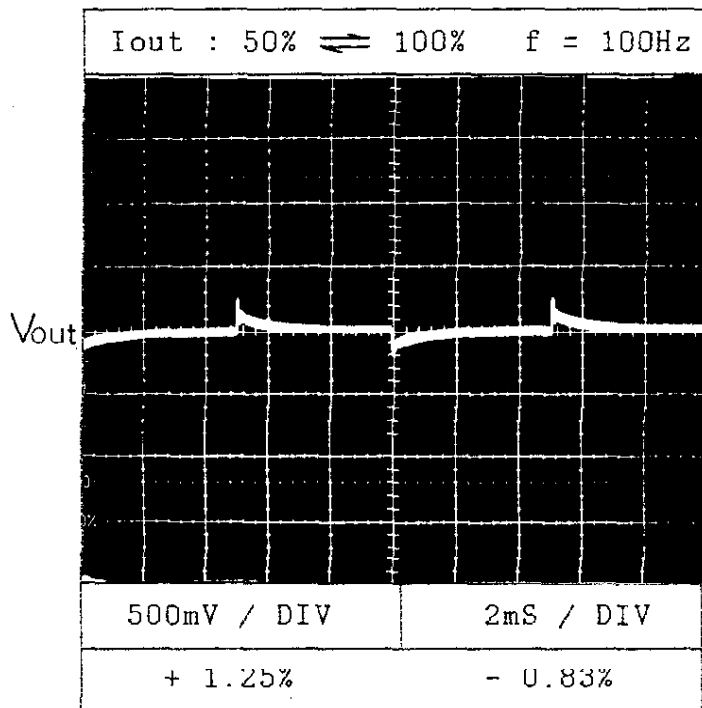
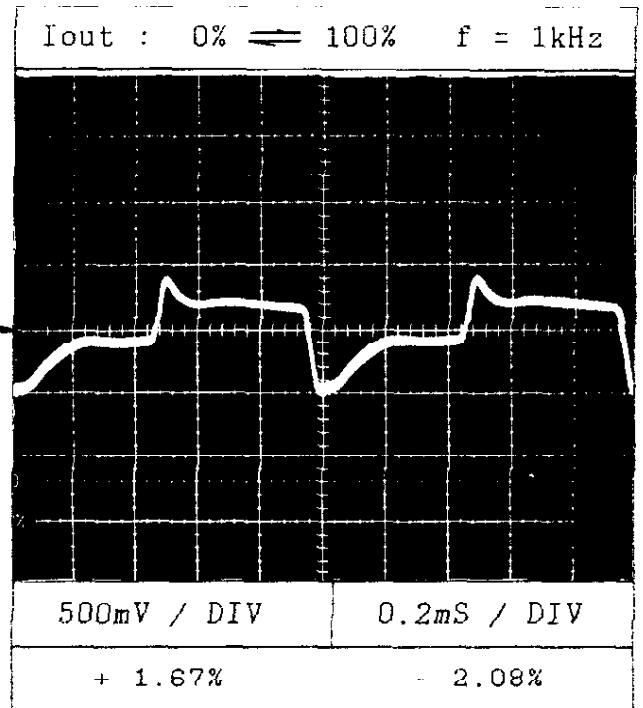
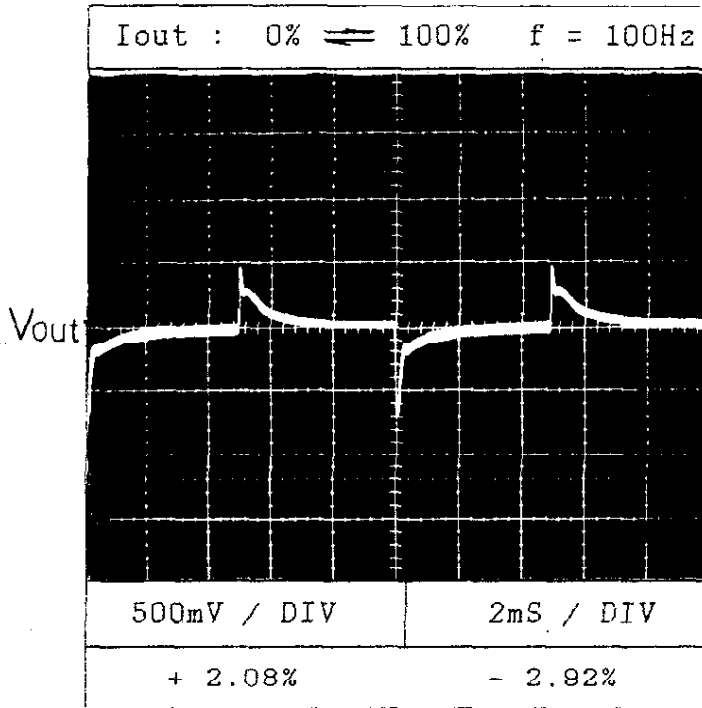

Dynamic Load Response

KWD15

Condition Vin : AC220V
Ta : 25°C

24V

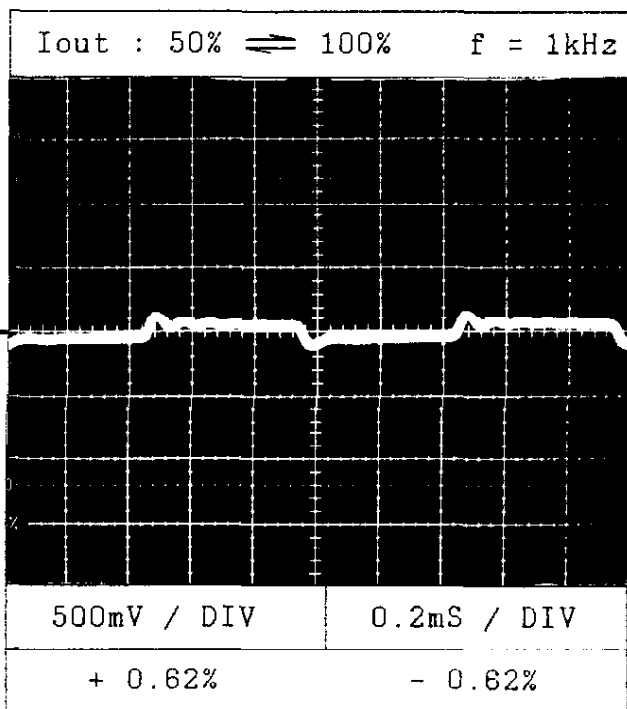
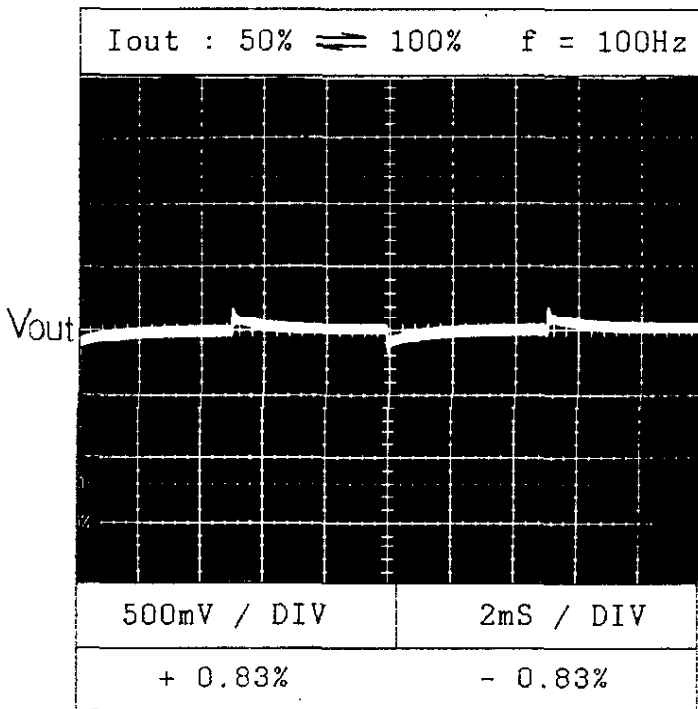
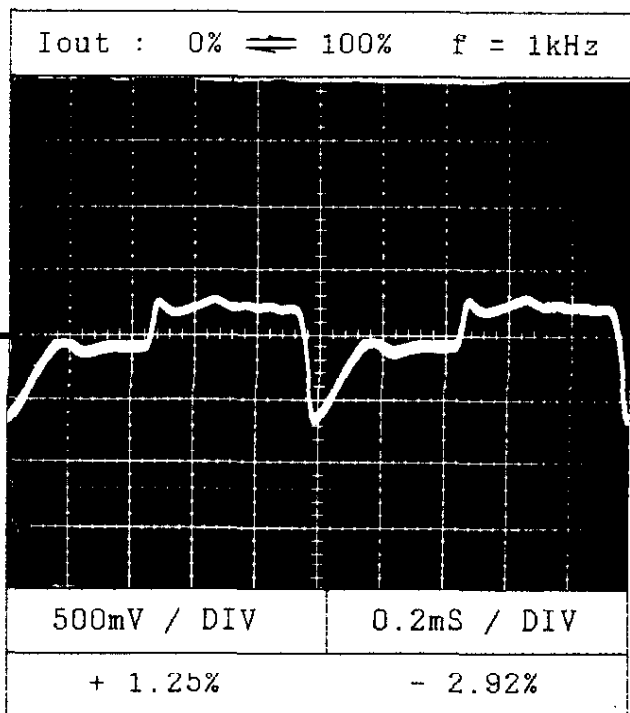
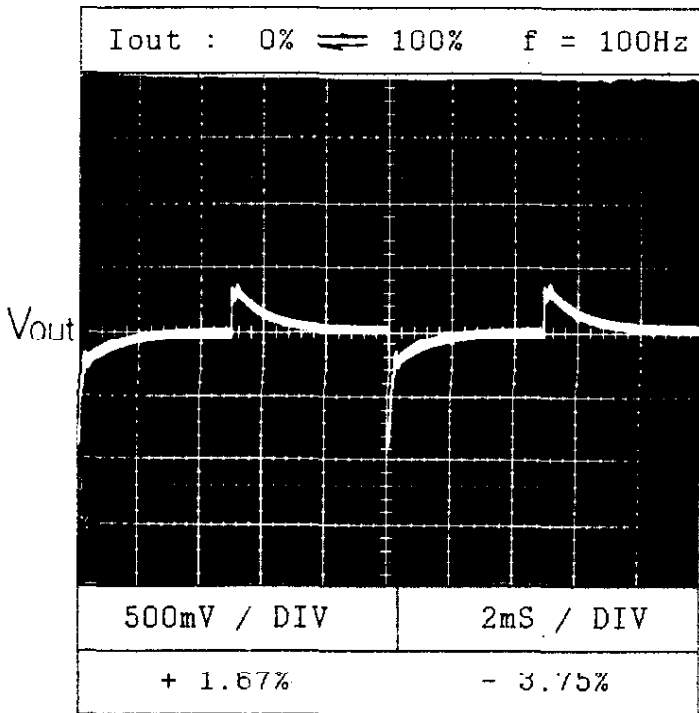

KWD15

Condition Vin : AC100V
 Iout: 100%
 Ta : 25 °C

±15V

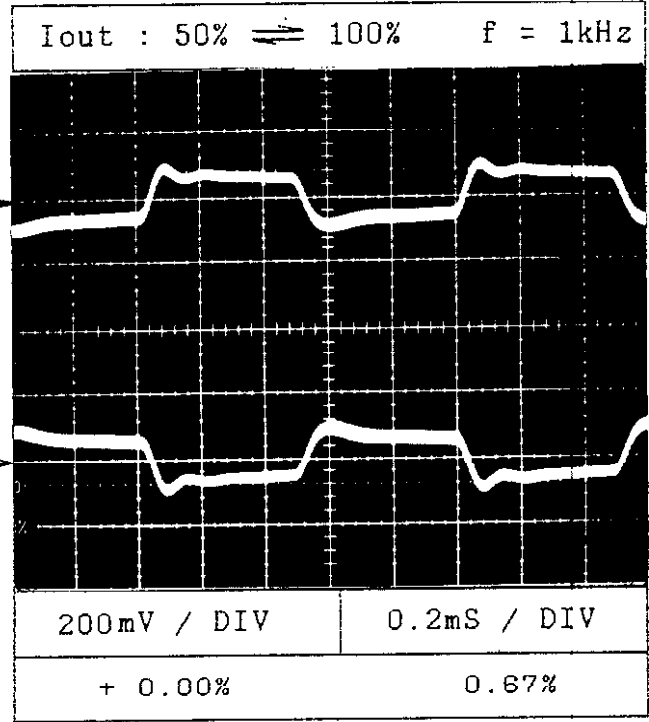
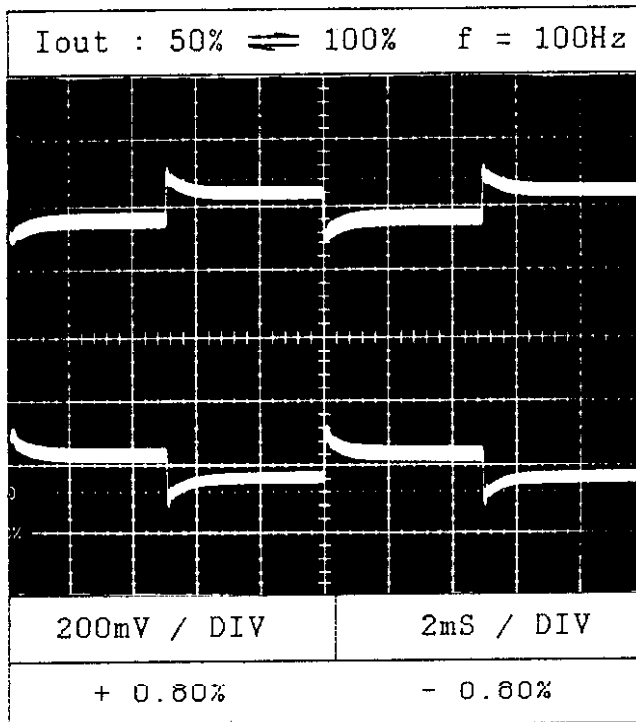
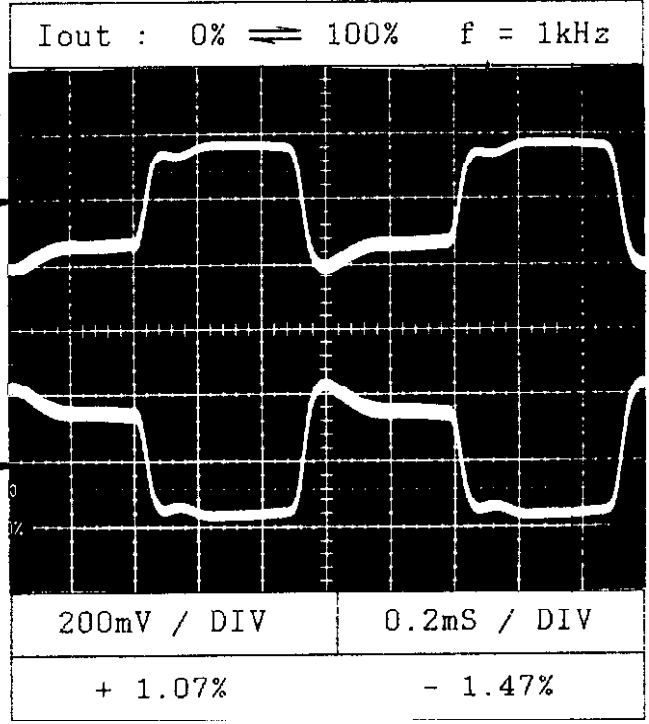
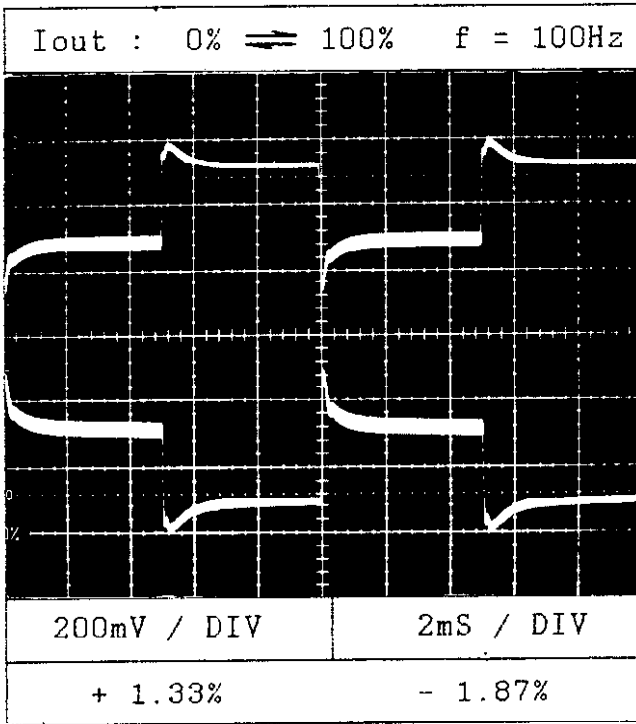

NOTE:

- When performing dynamic load for CH1:
- (1) Only the output waveform of this channel is taken.
 - (2) CH2 is at 100%

NOTE:

- When performing dynamic load for CH2:
- (1) Only the output waveform of this channel is taken.
 - (2) CH1 is at 100%

Condition Vin : AC220V
 Iout: 100%
 Ta : 25°C

±15V

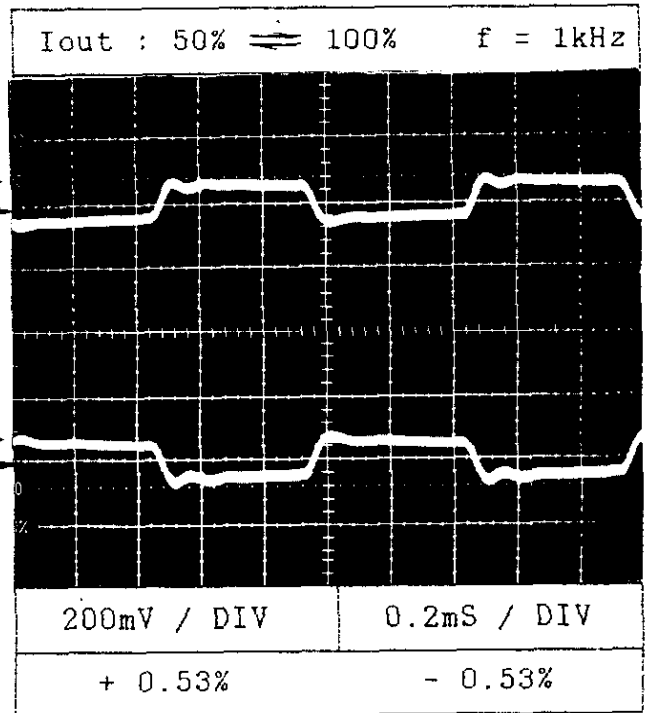
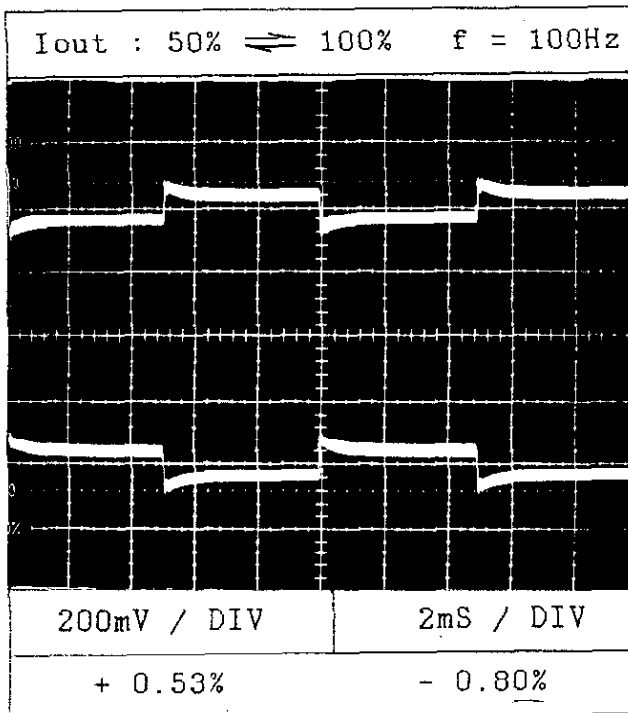
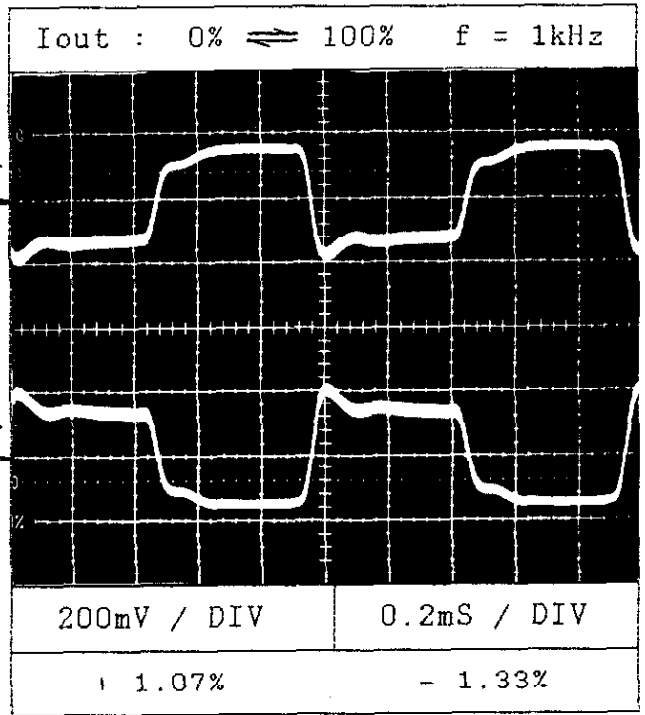
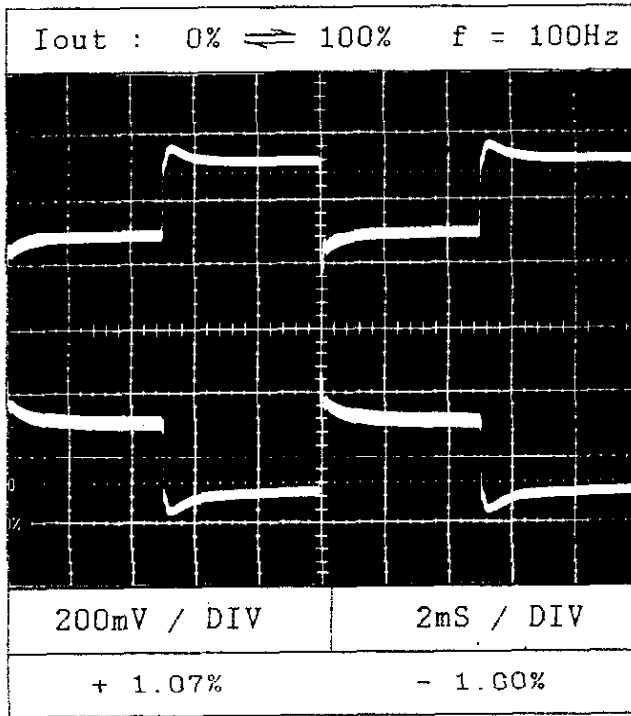

NOTE:

- When performing dynamic load for CH1:
- (1) Only the output waveform of this channel is taken.
 - (2) CH2 is at 100%

NOTE:

- When performing dynamic load for CH2:
- (1) Only the output waveform of this channel is taken.
 - (2) CH1 is at 100%

KWD15

Condition Vin : AC100V
Ta : 25°C

30V

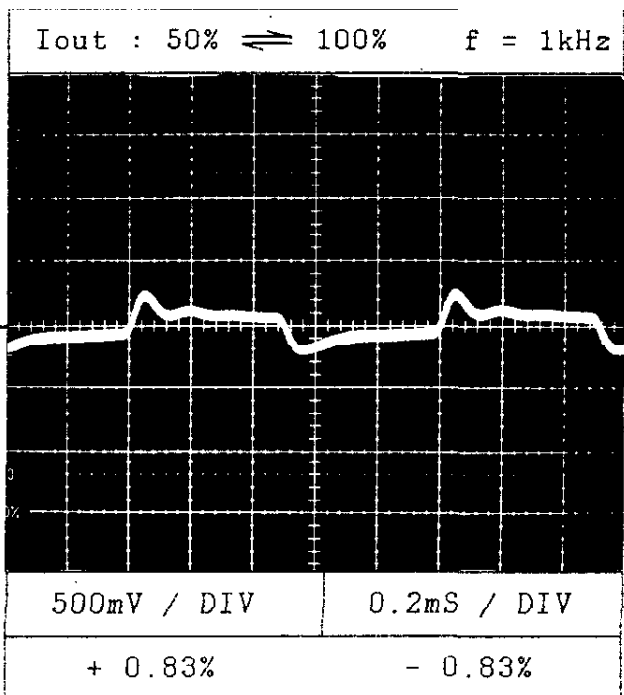
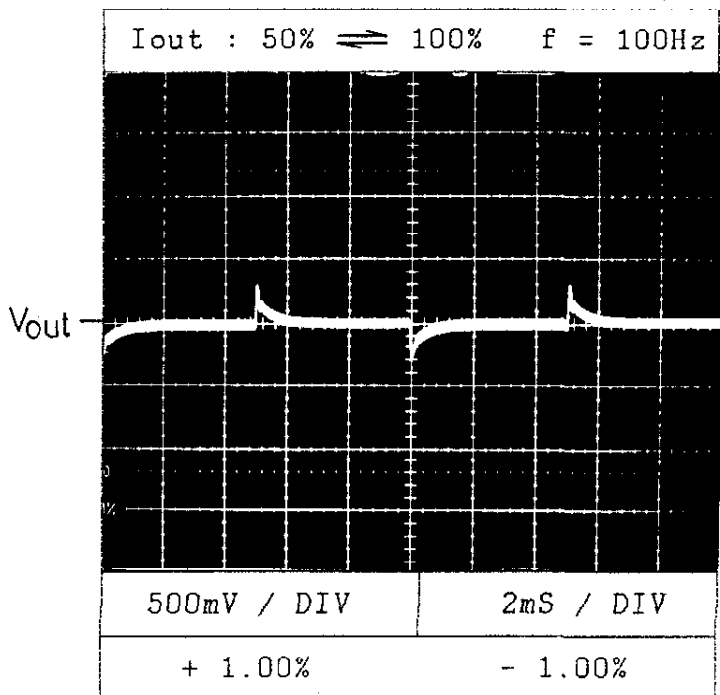
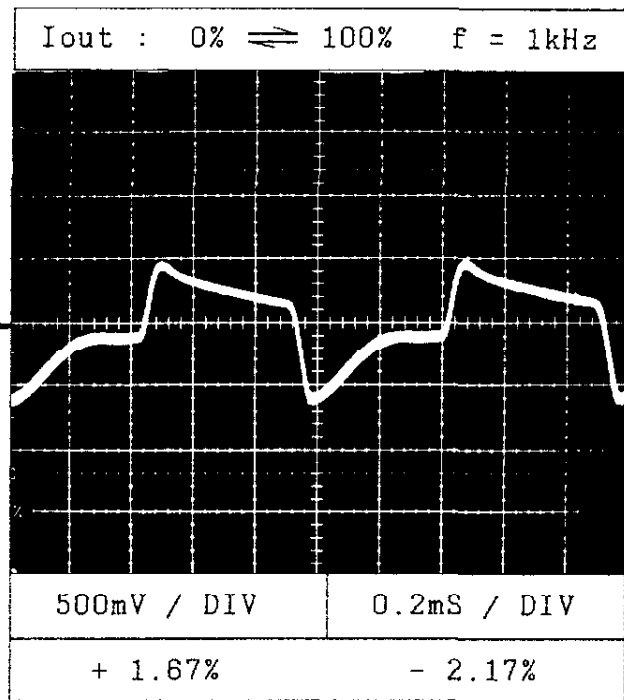
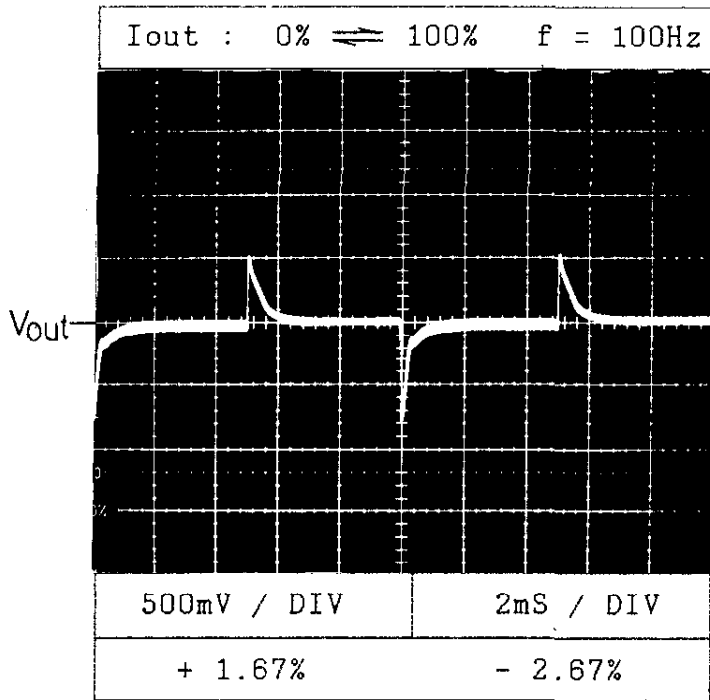

Dynamic Load Response

KWD15

Condition Vin : AC220V
Ta : 25 °C

30V

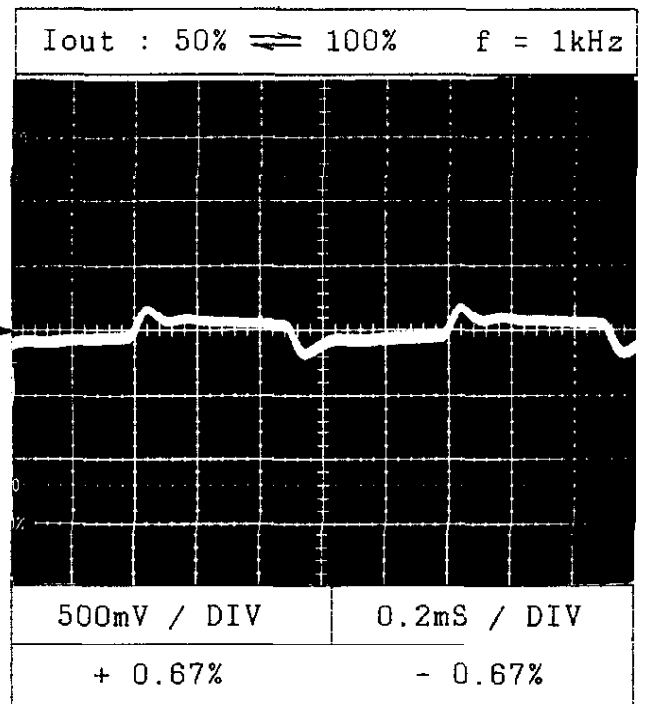
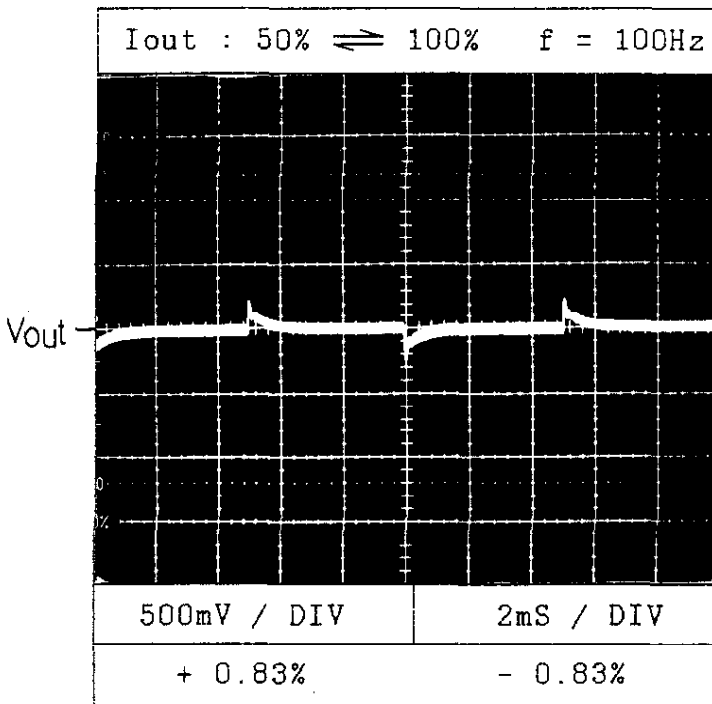
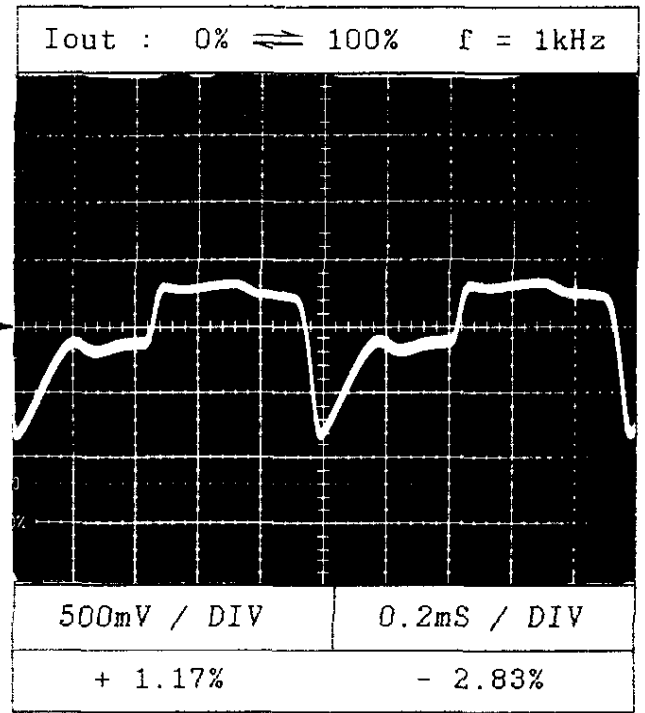
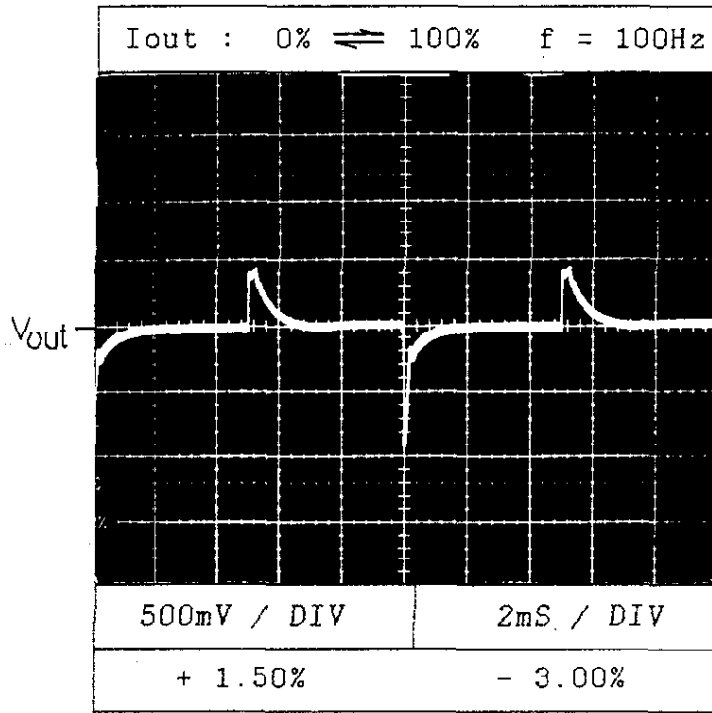

Condition Vin : AC100V
Iout : 100%
Ta : 25°C

±12V

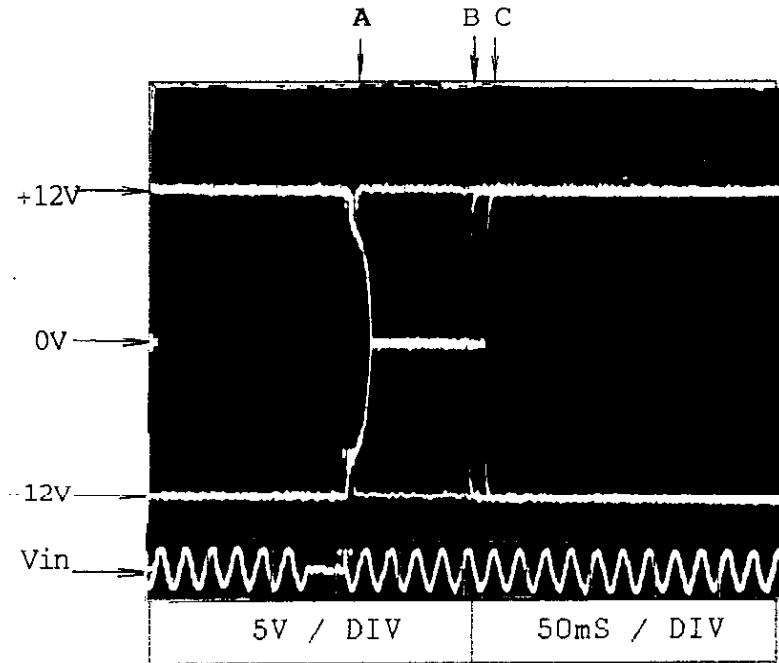

Brown out time:

- A : 31 mS
- B : 43 mS
- C : 53 mS

24V

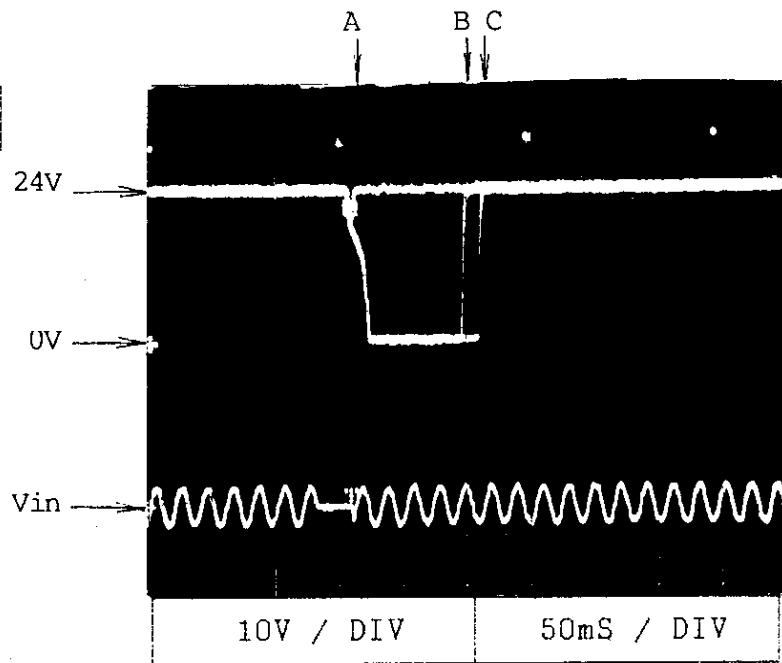

Brown out time:

- A : 31 mS
- B : 43 mS
- C : 53 mS

Condition Vin : AC220V
Iout : 100%
Ta : 25°C

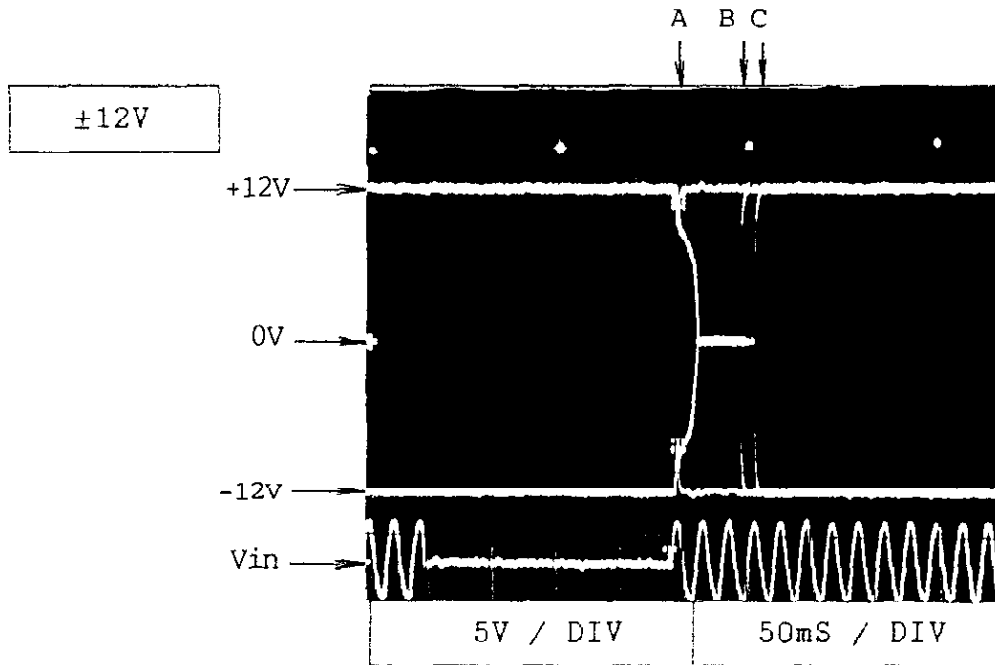

Brown out time:

- A : 191 mS
- B : 209 mS
- C : 219 mS

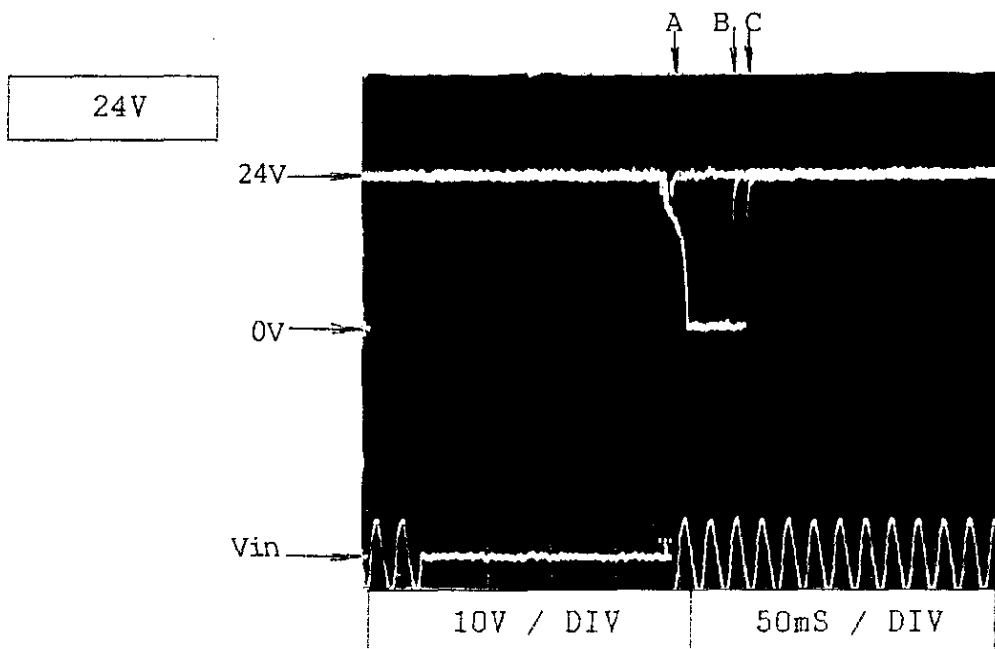

Brown out time:

- A : 185 mS
- B : 207 mS
- C : 217 mS

Condition Vin : AC100V
Iout : 100%
Ta : 25°C

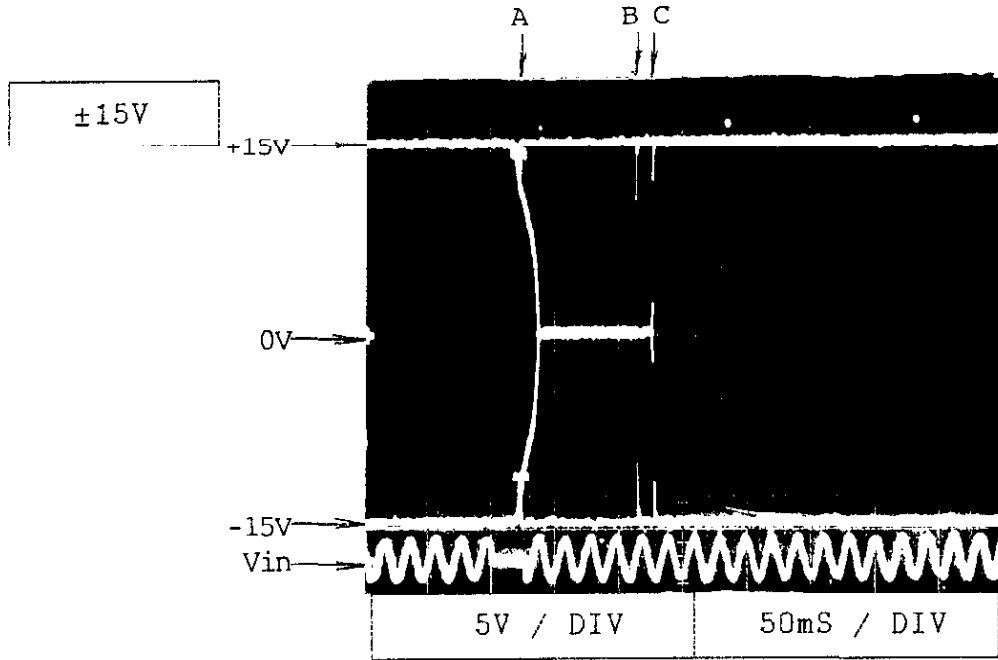

Brown out time:

A : 26 mS

B : 43 mS

C : 53 mS

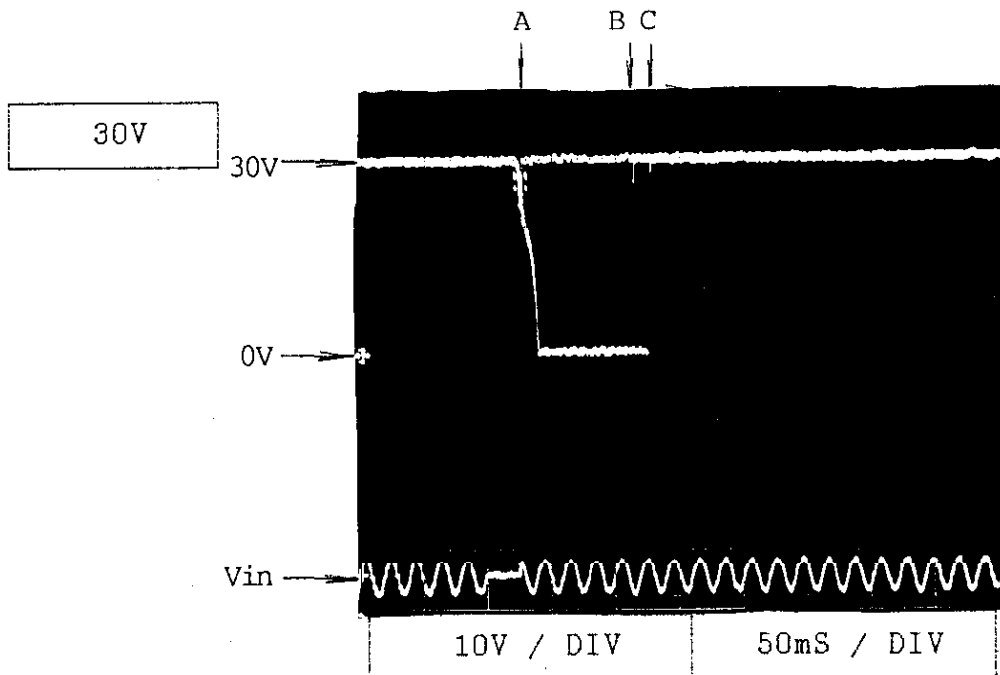

Brown out time:

A : 26 mS

B : 40 mS

C : 50 mS

Condition Vin : AC220V
Iout : 100%
Ta : 25°C

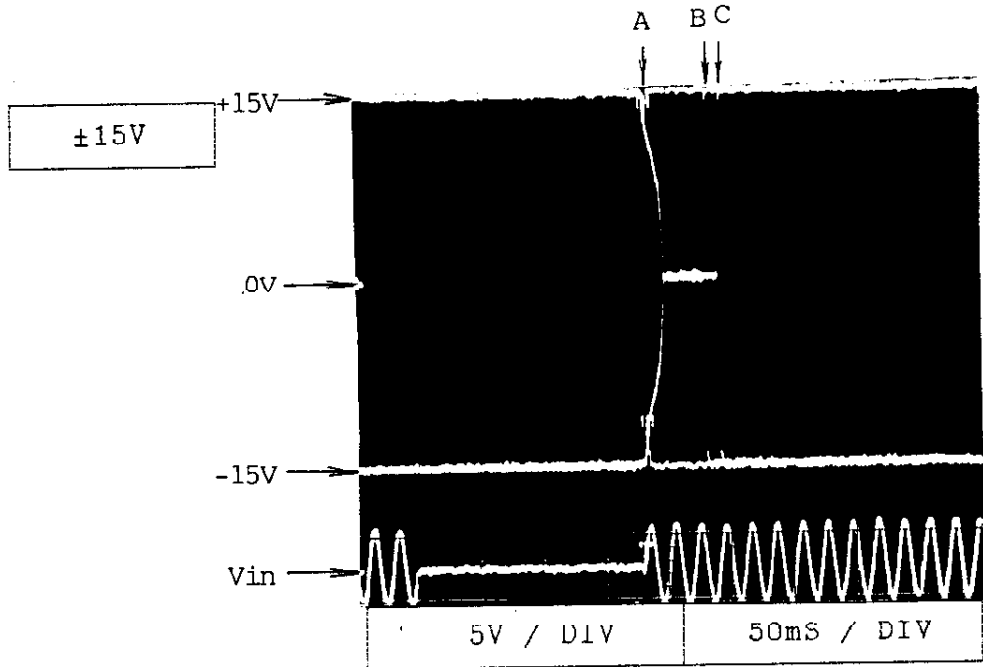

Brown out time:

- A : 176 mS
- B : 196 mS
- C : 206 mS

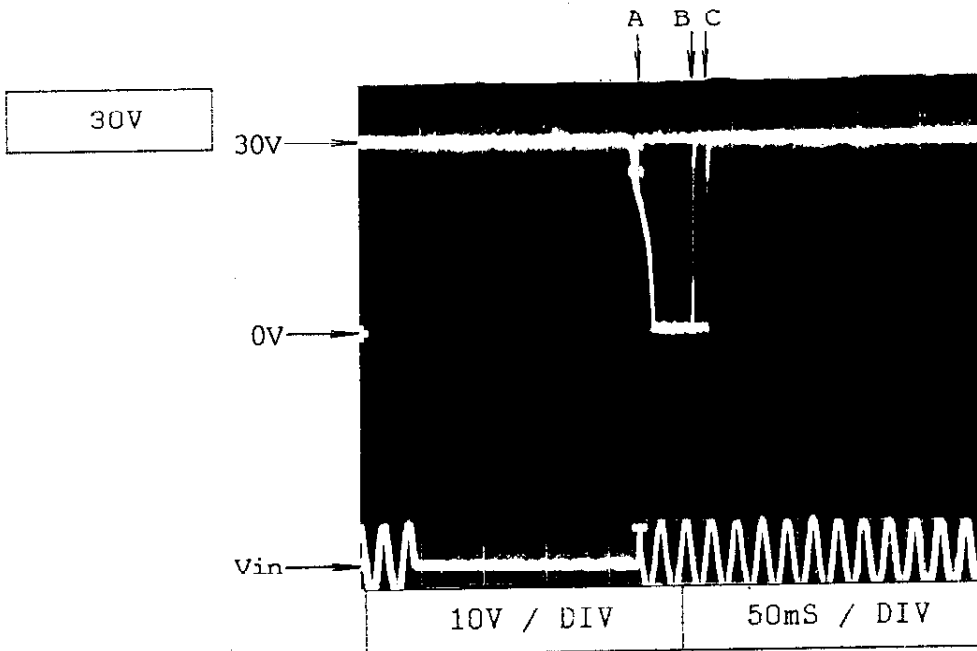

Brown out time:

- A : 177 mS
- B : 196 mS
- C : 206 mS

Condition Vin : AC100V
 Iout: 0% -----
 50% - - - - -
 100% _____
 Ta : 25°C

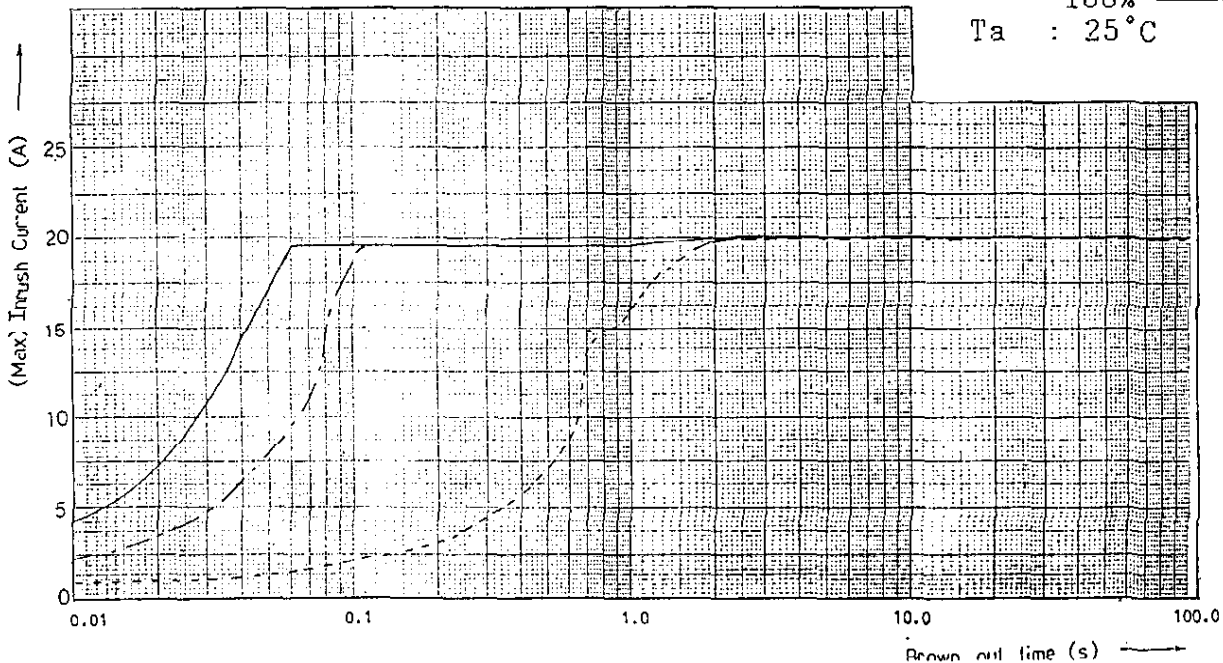

Condition Vin : AC230V
 Iout: 0% -----
 50% - - - - -
 100% _____
 Ta : 25°C

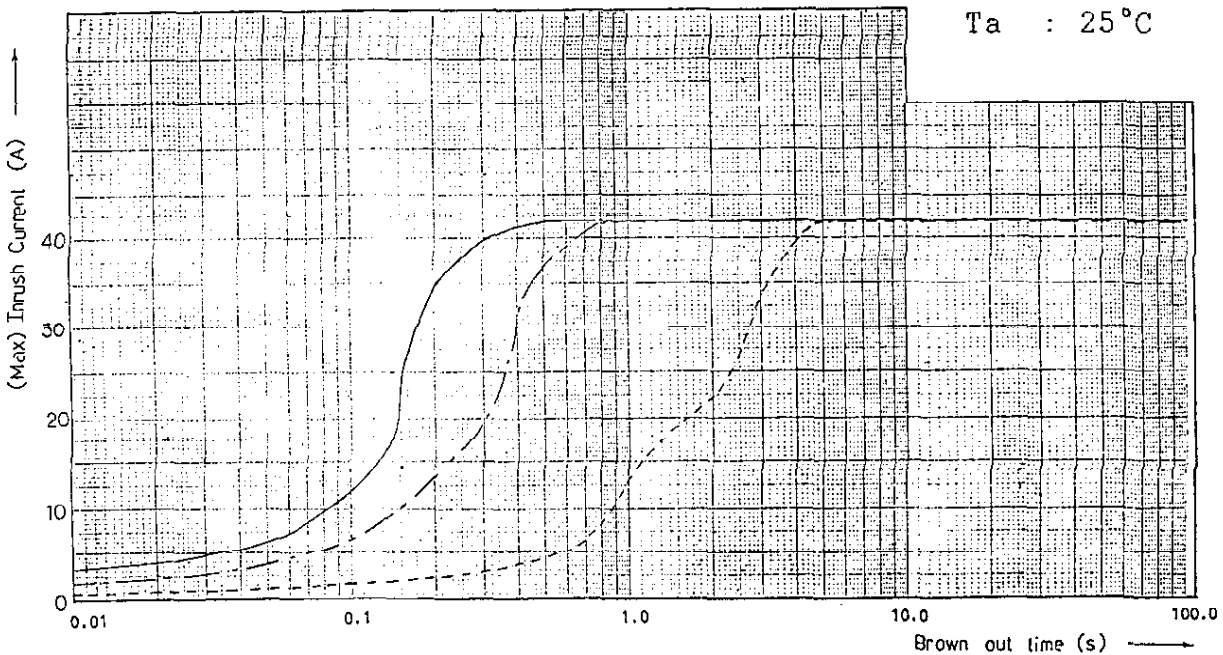

Inrush Current Waveform

KWD15

Condition Vin : AC100V
Iout : 100%
Ta : 25°C

Switch in phase
angle of input
AC voltage:

$$\phi = 0^\circ$$

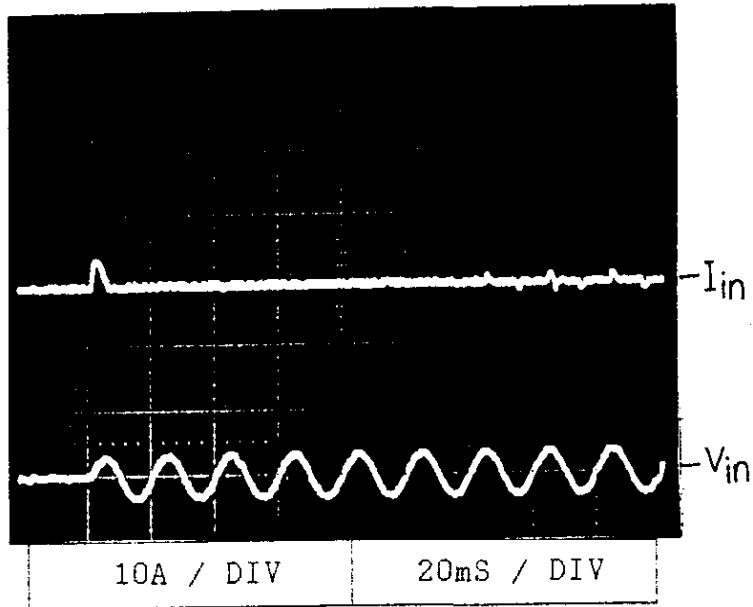

Switch in phase
angle of input
AC voltage:

$$\phi = 90^\circ$$

I_{peak}
(20A)

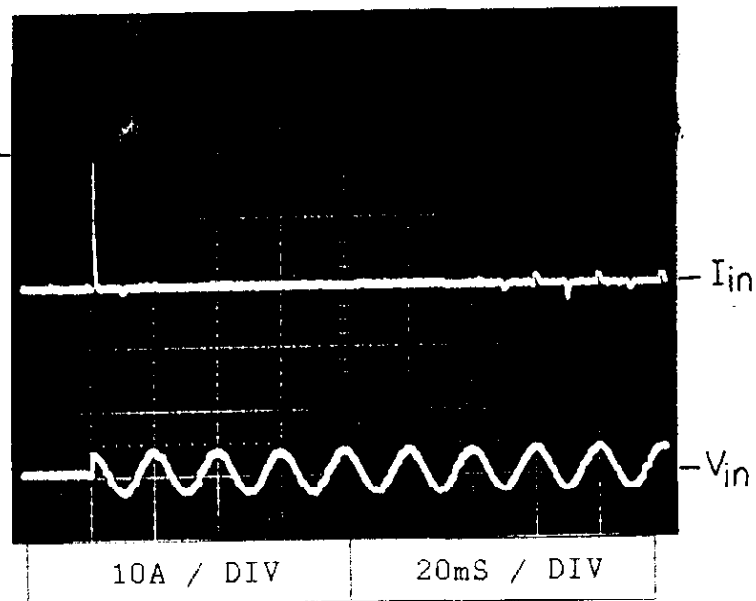

Inrush Current Waveform

KWD15

Condition Vin : AC230V
Iout : 100%
Ta : 25°C

Switch in phase angle of input AC voltage:

$$\phi = 0^\circ$$

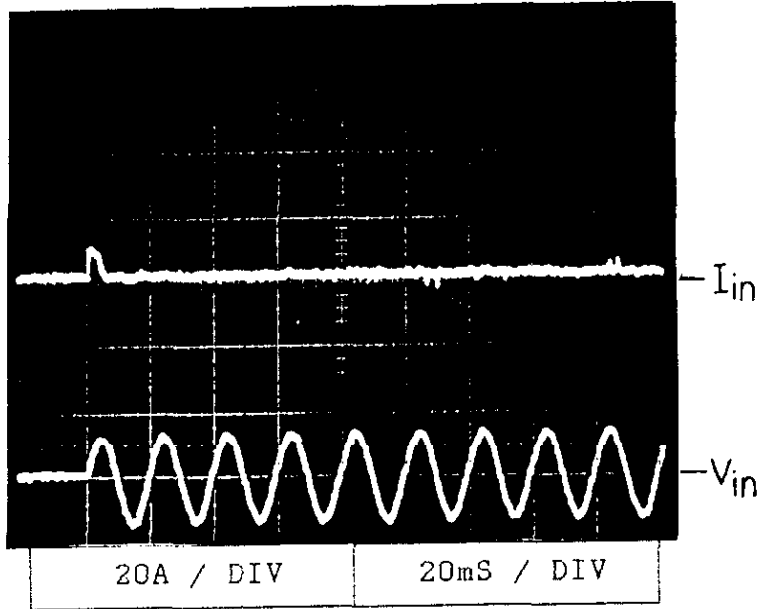

Switch in phase angle of input AC voltage:

$$\phi = 90^\circ$$

I_{peak}
(42A)

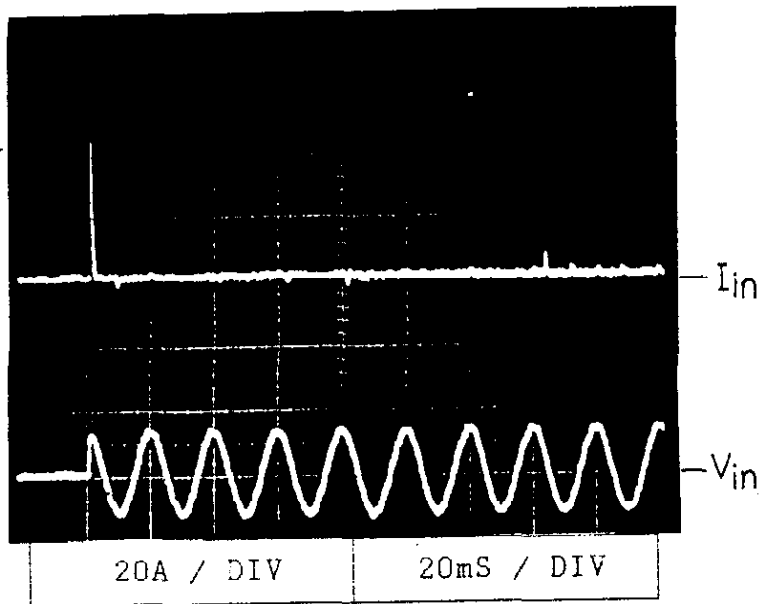

KWD15

Leakage Current

Condition

I_{out}: 100% —
0% - - -
T_a : 25°C

24V

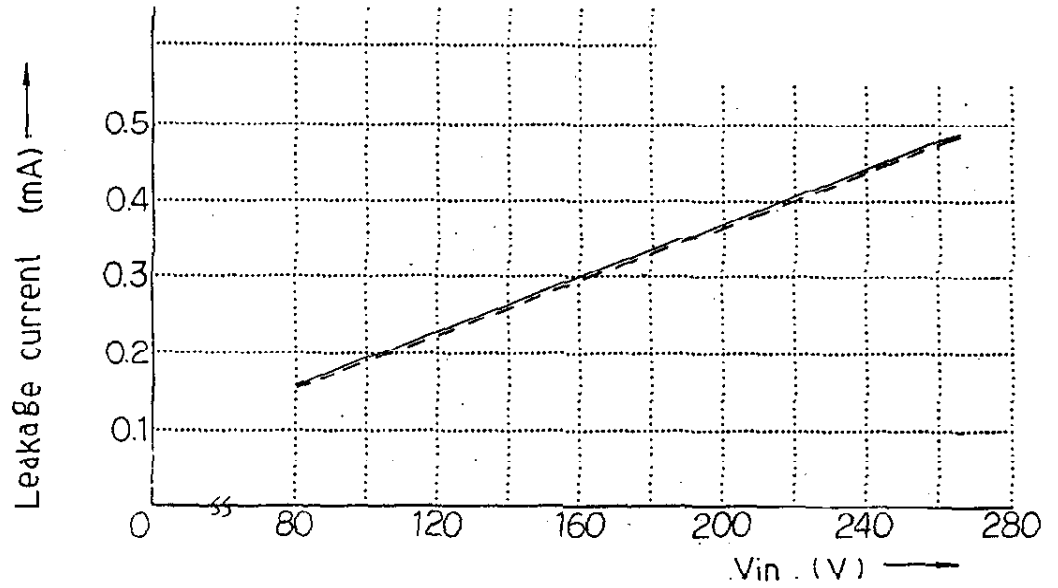

30V

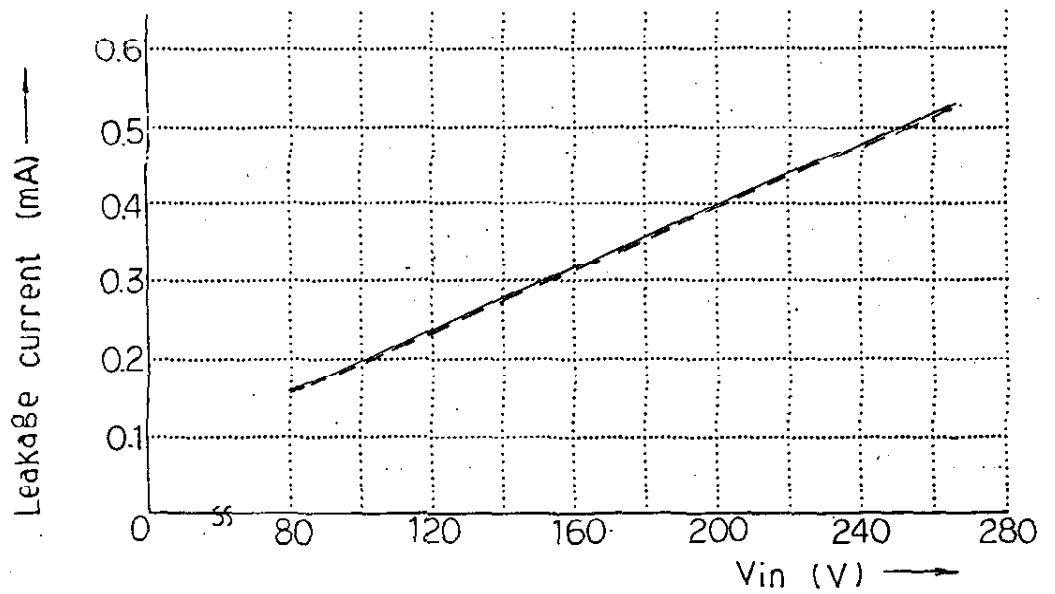

Condition Vin : AC100V
Iout : 100%
Ta : 25°C

Normal Mode

±12V

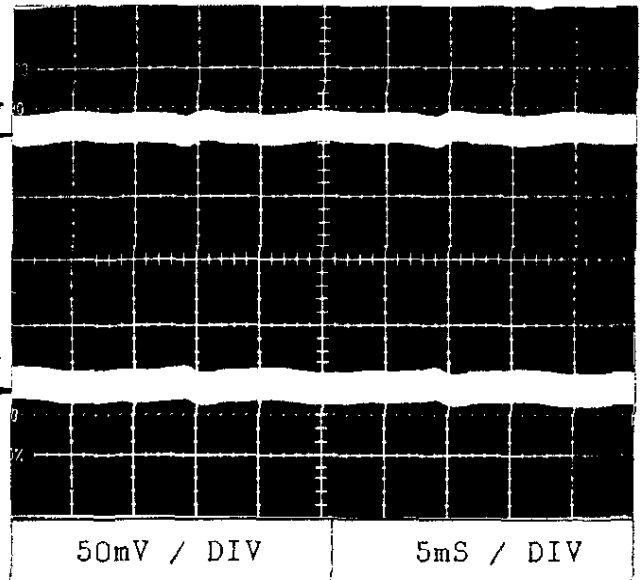
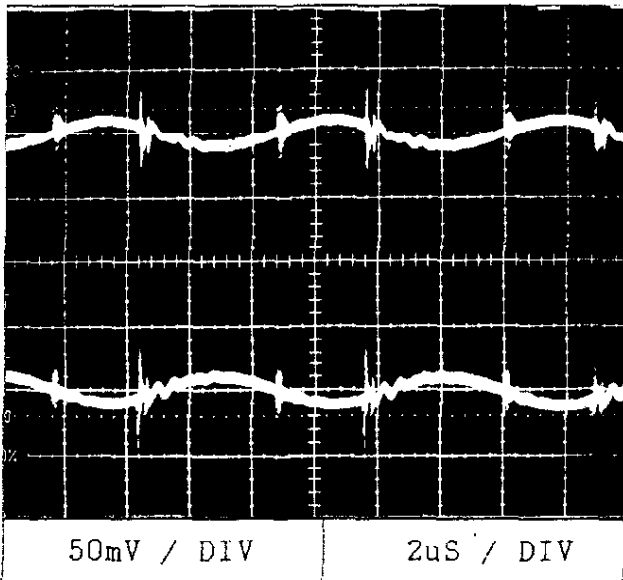

24V

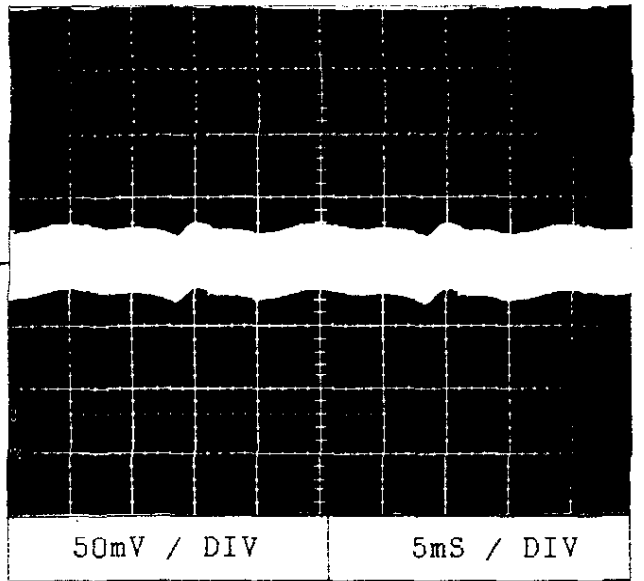
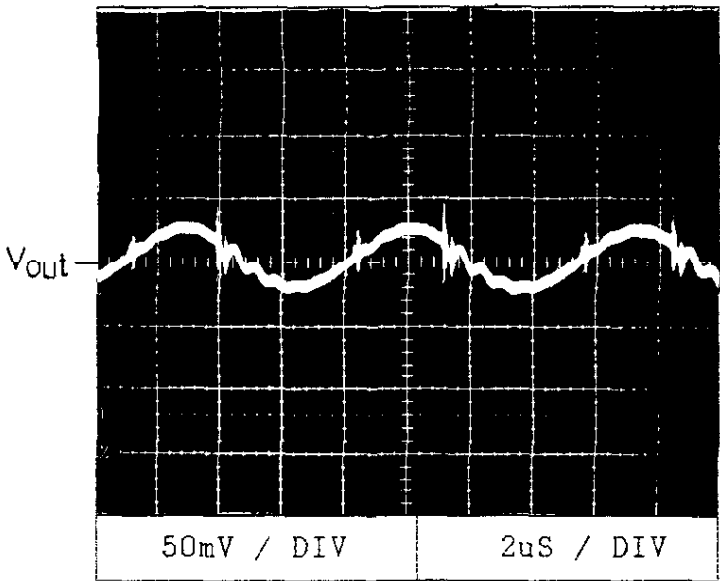

Output Ripple, Noise

KWD15

Condition Vin : AC100V
Iout : 100%
Ta : 25°C

Normal Mode

±15V

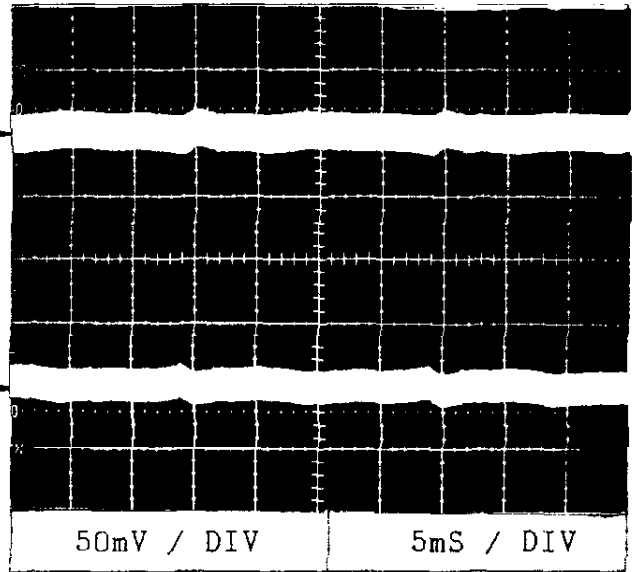
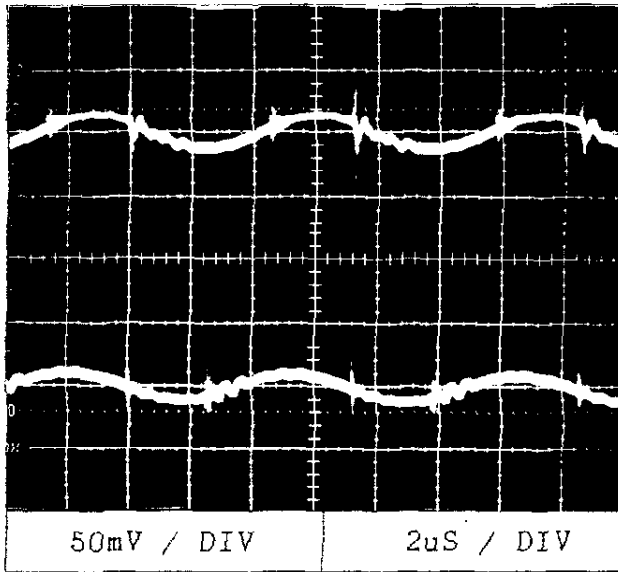

30V

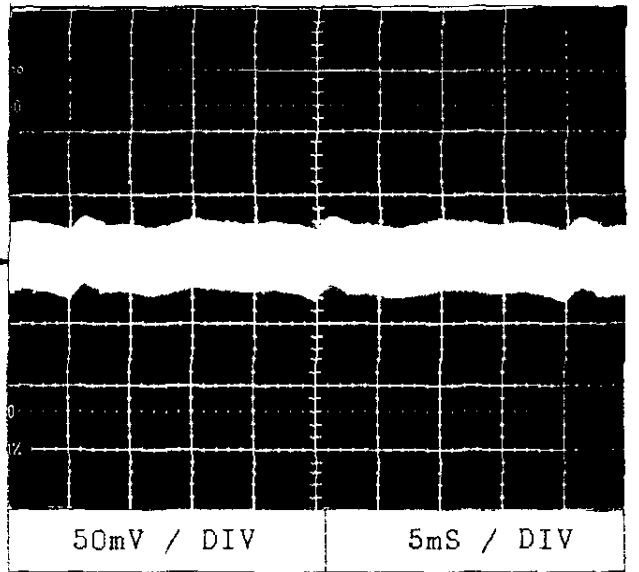
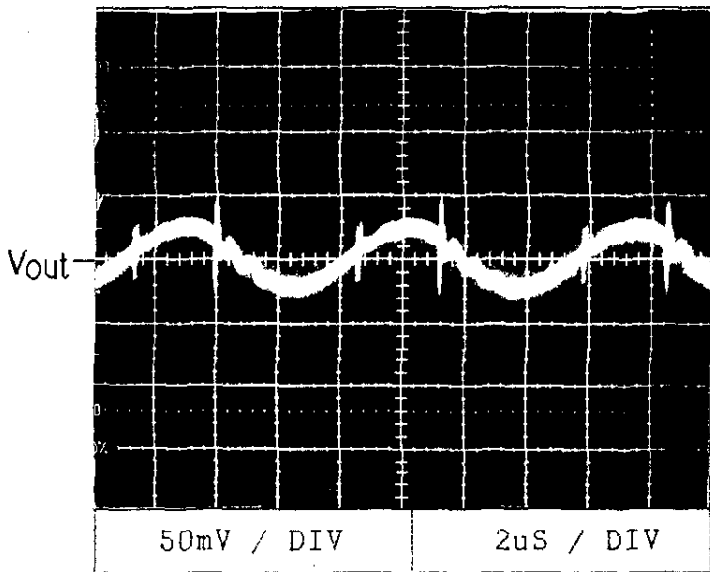

Output Ripple, Noise

KWD15

Condition Vin : AC100V
Iout : 100%
Ta : 25°C

Common + Normal Mode

±12V

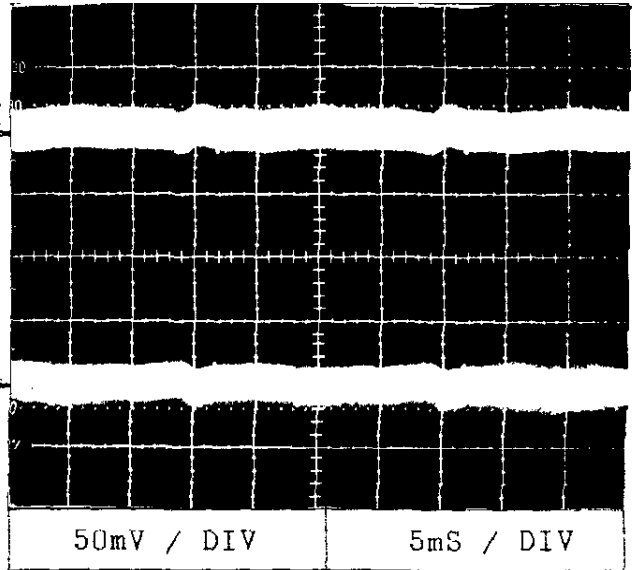
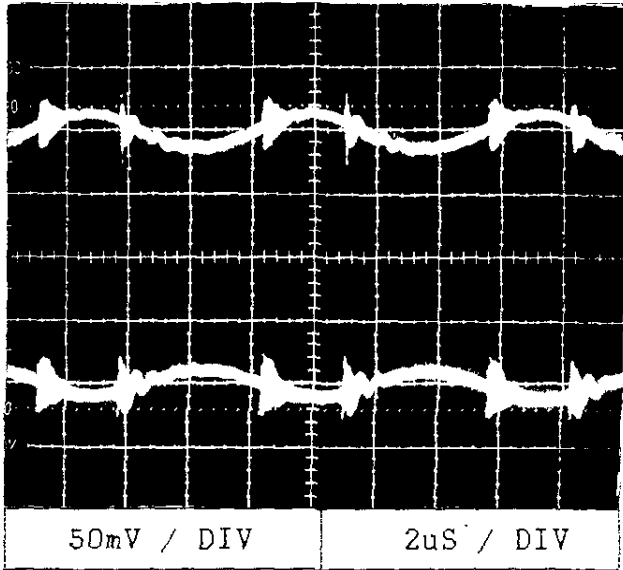

24V

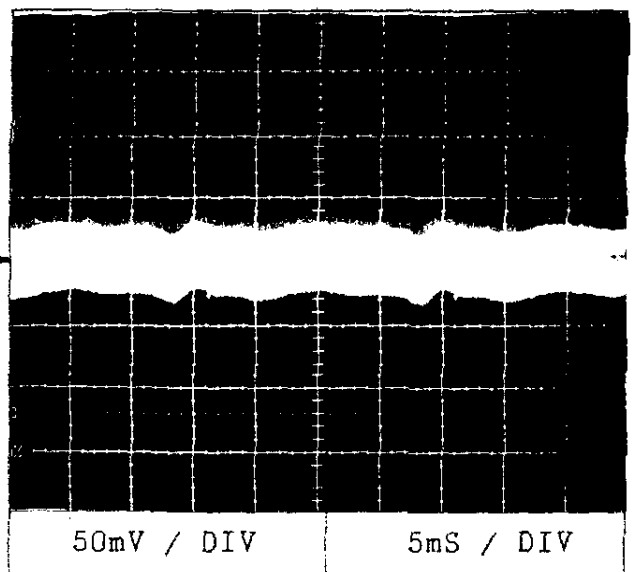
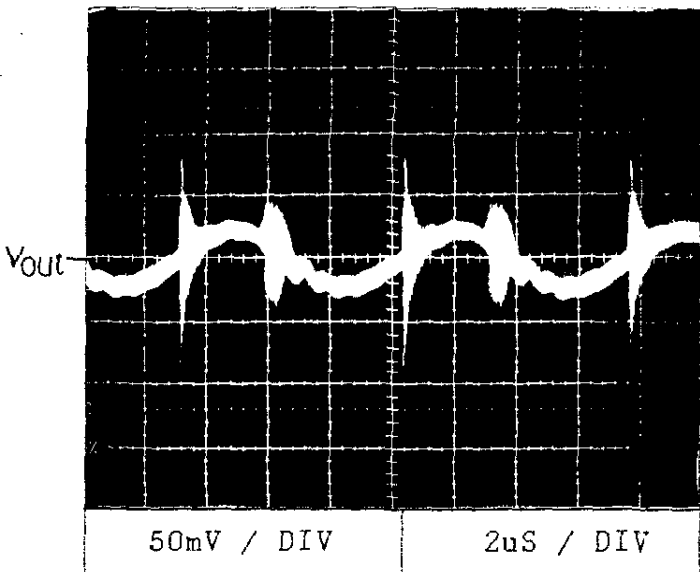

Output Ripple, Noise

KWD15

Condition Vin : AC100V
Iout : 100%
Ta : 25°C

Common + Normal Mode

±15V

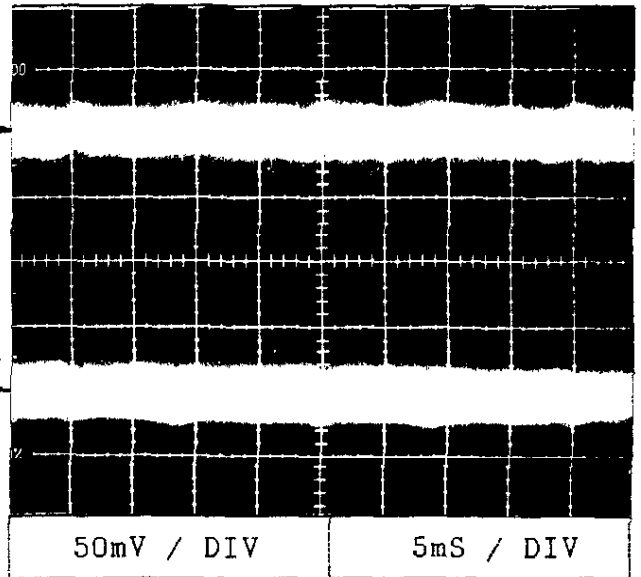
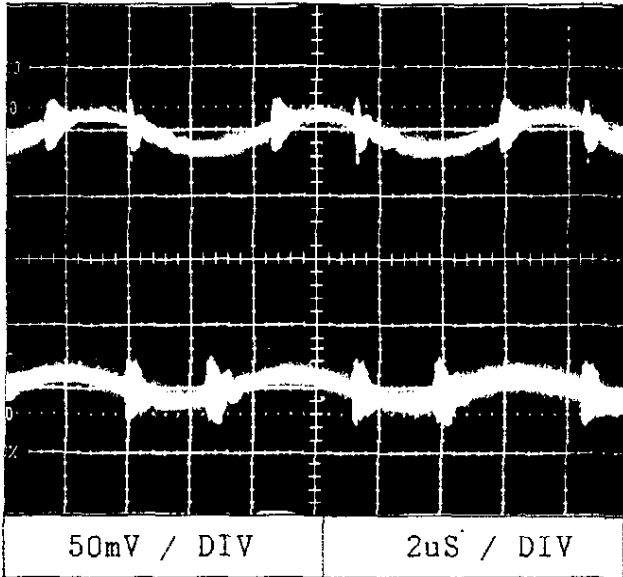

30V

