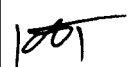

SWS300A

EVALUATION DATA

DWG.No CA768-53-01		
APPD	CHK	DWG
 8-DEC-09	Kevin 7-DEC-09	Mia Fea 4-DEC-09

INDEX

	PAGE
1. Evaluation Method	
1.1 Circuit used for determination	T-1~4
(1) Steady state data	
(2) Warm up voltage drift characteristics	
(3) Over current protection (OCP) characteristics	
(4) Over voltage protection (OVP) characteristics	
(5) Output rise characteristics	
(6) Output fall characteristics	
(7) Dynamic line response characteristics	
(8) Dynamic load response characteristics	
(9) Inrush current characteristics	
(10) Leakage current characteristics	
(11) Output ripple and noise waveform	
(12) Electro-Magnetic Interference characteristics	
1.2 List of equipment used	T-5
2. Characteristics	
2.1 Steady state data	
(1) Regulation - line and load, temperature drift	T-6
(2) Output voltage and Ripple noise voltage vs. input voltage	T-7
(3) Efficiency and Input current vs. Output current	T-8
(4) Power factor and Input current vs. Output current	T-9
2.2 Warm up voltage drift characteristics	T-10
2.3 Over current protection (OCP) characteristics	T-11~12
2.4 Over voltage protection (OVP) characteristics	T-13
2.5 Output rise characteristics	T-14~15
2.6 Output fall characteristics	T-16~17

2.7	Hold up time characteristics	T-18
2.8	Dynamic line response characteristics	T-19
2.9	Dynamic load response characteristics	T-20~25
2.10	Response to brownout characteristics	T-26~27
2.11	Inrush current waveform	T-28~29
2.12	Input current waveform	T-30
2.13	Input current harmonics	T-31
2.14	Leakage current characteristics	T-32
2.15	Output ripple and noise waveform	T-33~36
2.16	Electro-Magnetic Interference characteristics	T-37~48

Terminology used

	Definition	
V_{in}	Input voltage
V_{out}	Output voltage
I_{in}	Input current
I_{out}	Output current
T_a	Ambient temperature
f	Frequency
FG	Frame Ground

1. Evaluation method

1.1 Circuit used for determination

(1) Steady state data

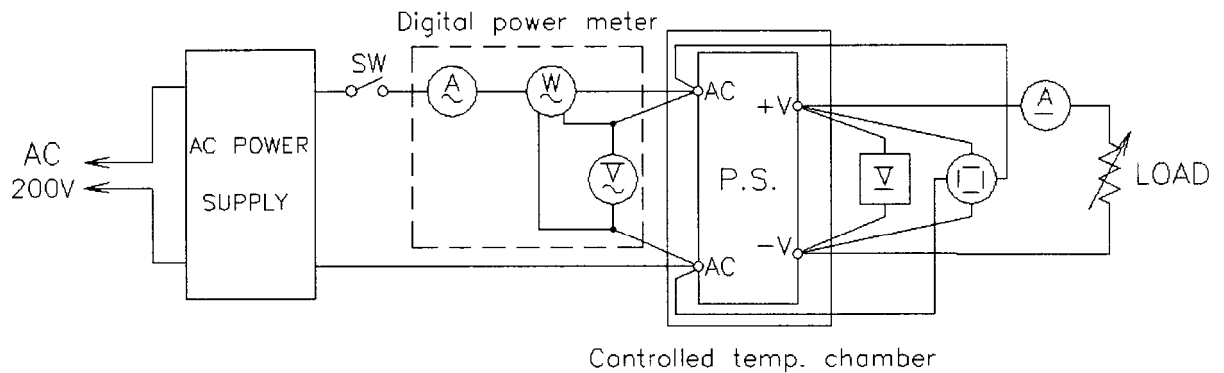

(2) Warm up voltage drift characteristics
Same as Steady state data

(3) Over current protection (OCP) characteristics
Same as Steady state data

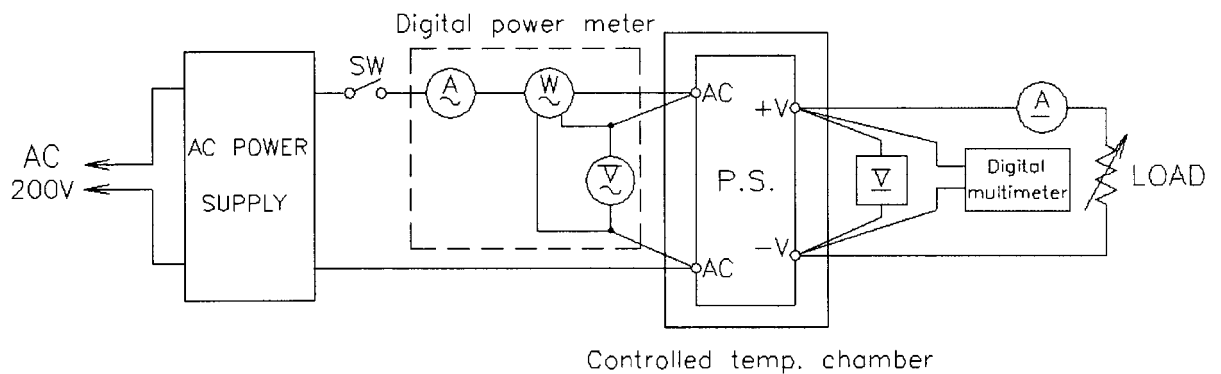

(4) Over voltage protection (OVP) characteristics
Same as Steady state data

(5) Output rise characteristics
Same as Steady state data

(6) Output fall characteristics
Same as Steady state data

(7) Dynamic line response characteristics
Same as Steady state data

(8) Dynamic load response characteristics

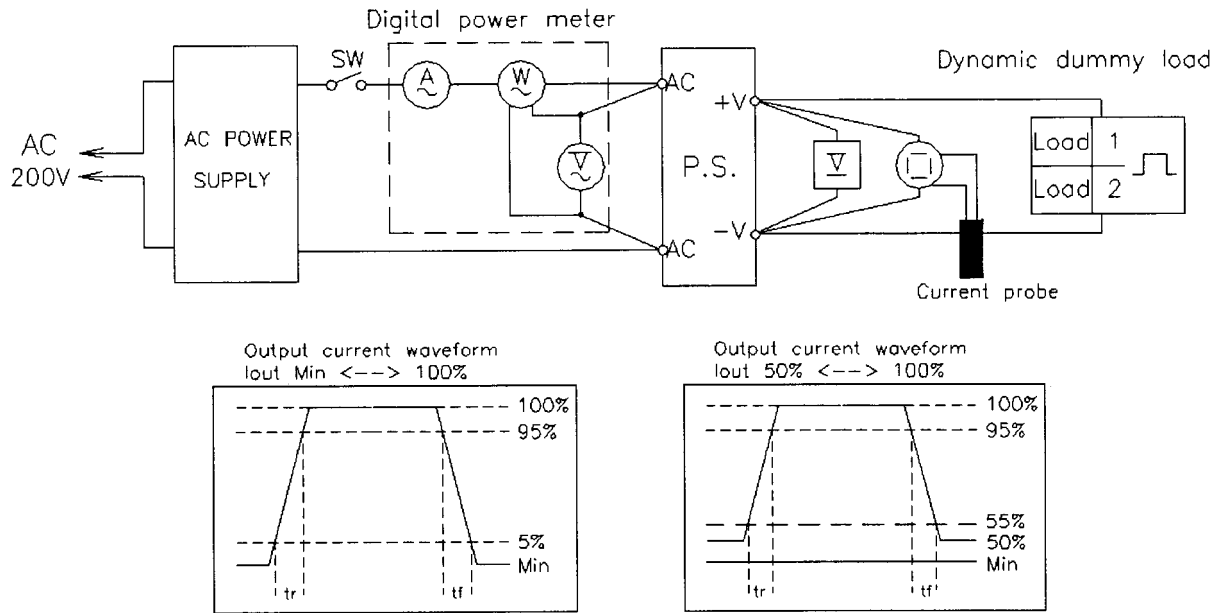

(9) Inrush current characteristics

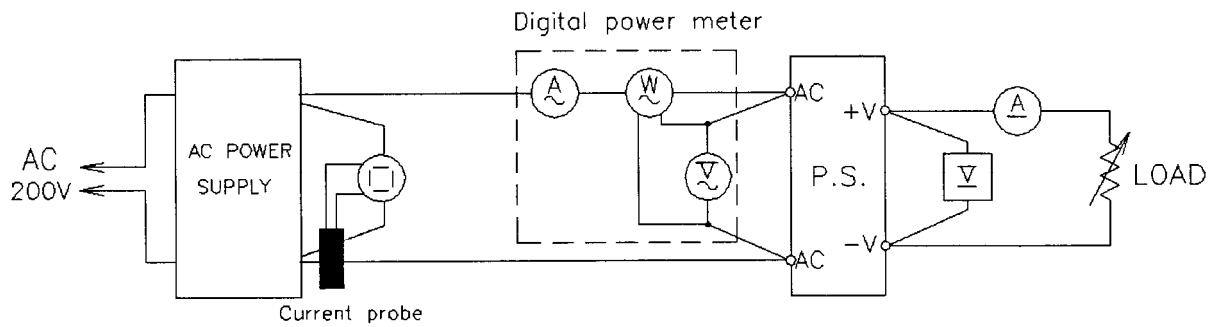

(10) Leakage current characteristics

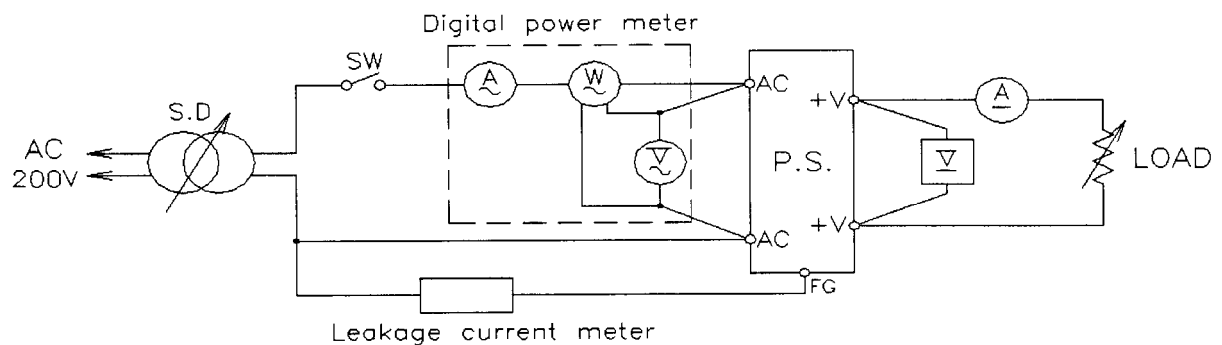

Range used---AC (For SIMPSON TYPE 228)

(11) Output ripple and noise waveform

(a) Normal Mode (using a twisted pair terminated with 0.1uF and 47uF capacitor at 20MHz)

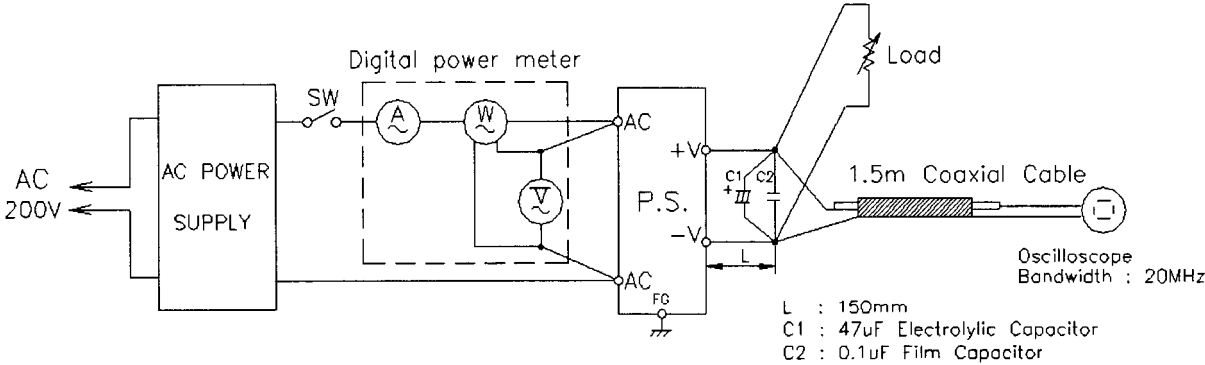

(b) Normal + Common Mode

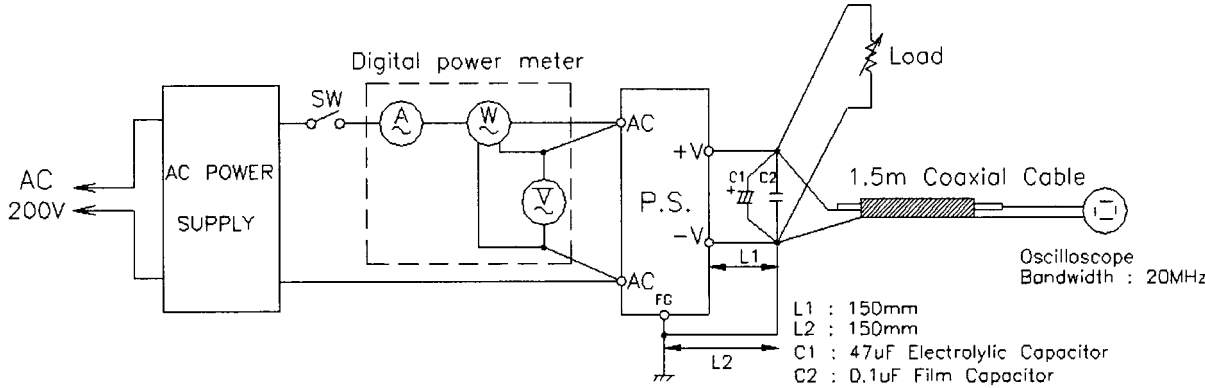

(12) Electro-Magnetic Interference characteristics

(a) Conducted Emission Noise

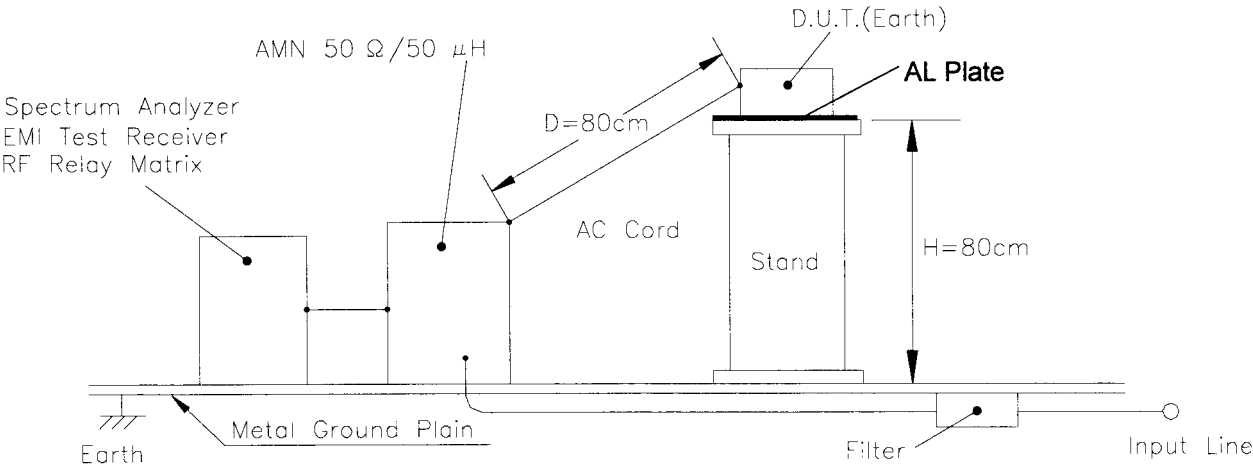

(12) Electro-Magnetic Interference characteristics

(b) Radiated Emission Noise

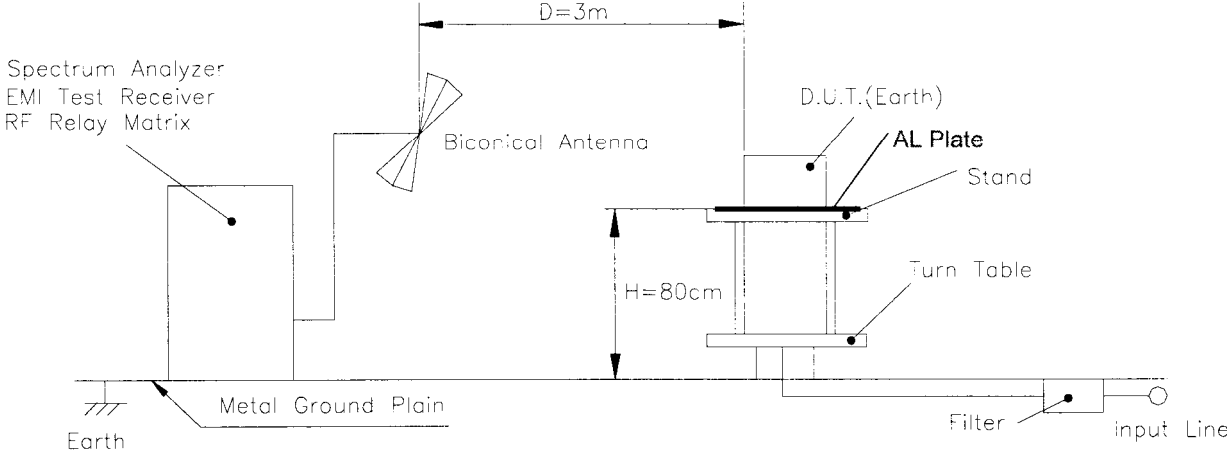

1.2 List of equipment used

	EQUIPMENT USED	MANUFACTURER	MODEL NO.
1	OSCILLOSCOPE	TEKTRONIX	TAS 475
2	DIGITAL STORAGE OSCILLOSCOPE	TEKTRONIX	TDS 724D/540A
3	DIGITAL MULTIMETER	FLUKE	45
4	DIGITAL POWER METER	YOKOGAWA	WT110/WT210
5	CURRENT PROBE/AMPLIFIER	TEKTRONIX	TCP404XL/TCPA400
6	DYNAMIC DUMMY LOAD	CHROMA	63030/63201
7	DYNAMIC DUMMY LOAD	KIKUSUI	PLZ1004W
8	CONTROLLED TEMP. CHAMBER	ESPEC	SU-241
9	LEAKAGE CURRENT METER	SIMPSON	228
10	AC SOURCE	KIKUSUI	PCR-2000L
11	AC SOURCE	CHROMA	6530
12	POWER ANALYZER	CHROMA	6630
13	EMI TEST RECEIVER	ROHDE&SCHWARZ	ESCI
14	EMI TEST RECEIVER	ROHDE&SCHWARZ	ESI26
15	LISN	ROHDE&SCHWARZ	ENV216
16	ANTENNA	ROHDE&SCHWARZ	HL562

2. Characteristics

2.1 Steady state data

(1) Regulation - line and load, Temperature drift

5V

1. Regulation-line and load Condition: Ta : 25°C

Iout \ Vin	85VAC	115VAC	230VAC	265VAC	line regulation	
0%	5.003V	5.002V	5.002V	5.002V	0.001V	0.020%
50%	4.996V	4.994V	4.994V	4.994V	0.002V	0.040%
100%	4.989V	4.986V	4.986V	4.986V	0.003V	0.060%
load regulation	0.014V	0.016V	0.016V	0.016V		
	0.280%	0.320%	0.320%	0.320%		

2. Temperature drift Conditions: Vin = 115VAC
Iout = 100%

Ta	-10°C	+25°C	+50°C	temperature stability	
Vout	4.981V	4.986V	4.984V	0.005V	0.100%

12V

1. Regulation-line and load Condition: Ta : 25°C

Iout \ Vin	85VAC	115VAC	230VAC	265VAC	line regulation	
0%	12.019V	12.016V	12.017V	12.016V	0.003V	0.025%
50%	12.013V	12.011V	12.012V	12.011V	0.002V	0.017%
100%	12.007V	12.004V	12.005V	12.005V	0.003V	0.025%
load regulation	0.012V	0.012V	0.012V	0.011V		
	0.100%	0.100%	0.100%	0.092%		

2. Temperature drift Conditions: Vin = 115VAC
Iout = 100%

Ta	-10°C	+25°C	+50°C	temperature stability	
Vout	12.021V	12.004V	11.969V	0.052V	0.433%

24V

1. Regulation-line and load Condition: Ta : 25°C

Iout \ Vin	85VAC	115VAC	230VAC	265VAC	line regulation	
0%	24.015V	24.015V	24.014V	24.014V	0.001V	0.004%
50%	24.013V	24.012V	24.012V	24.012V	0.001V	0.004%
100%	24.011V	24.009V	24.009V	24.009V	0.002V	0.008%
load regulation	0.004V	0.006V	0.005V	0.005V		
	0.017%	0.025%	0.021%	0.021%		

2. Temperature drift Conditions: Vin = 115VAC
Iout = 100%

Ta	-10°C	+25°C	+50°C	temperature stability	
Vout	24.010V	24.009V	23.986V	0.024V	0.100%

(2) Output voltage and Ripple voltage vs. Input voltage

Conditions: Iout : 100%

Ta : -10°C -----
 : 25°C - - - - -
 : 50°C ———

5V

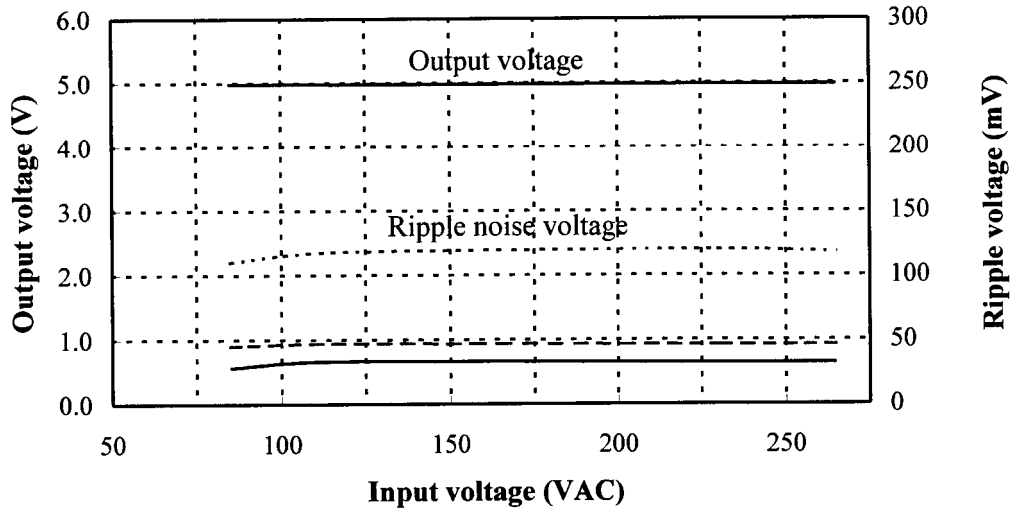

12V

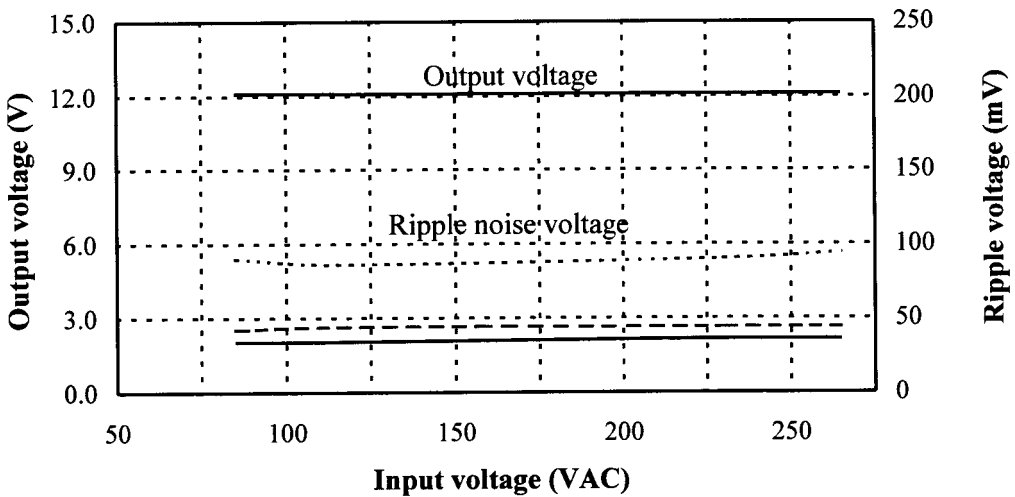

24V

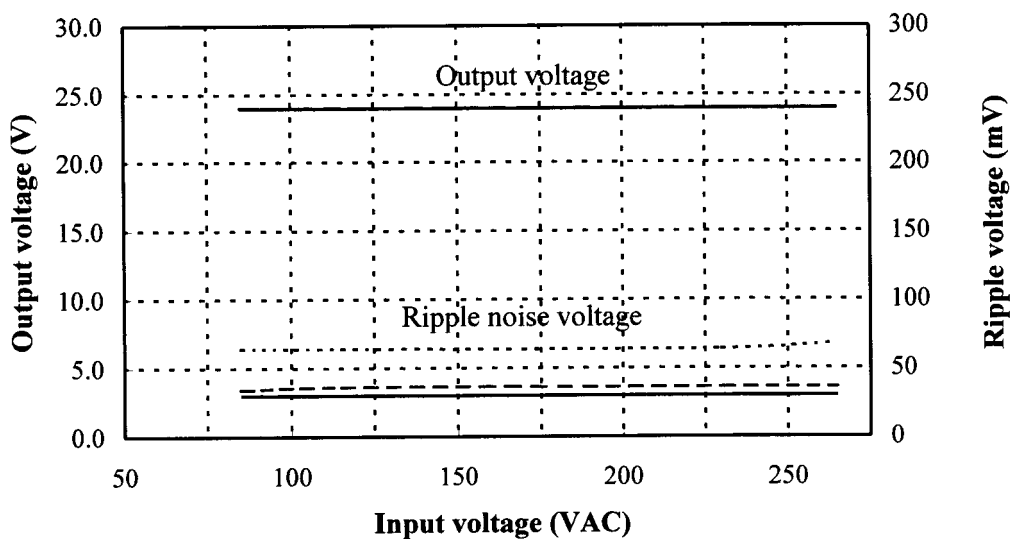

(3) Efficiency and input current vs. output current

Conditions: V_{in} : 85VAC -----
 : 115VAC - - - - -
 : 230VAC ————
 : 265VAC - · - · -

T_a : 25°C

5V

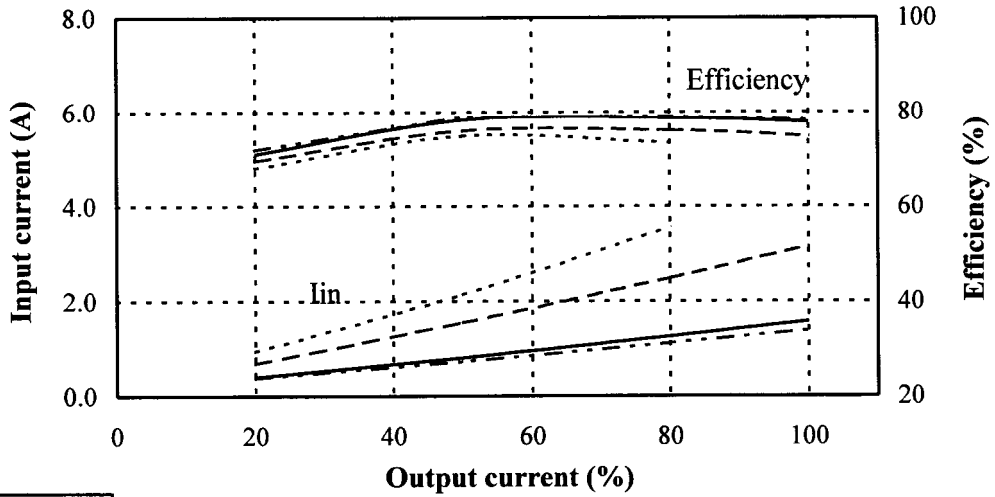

12V

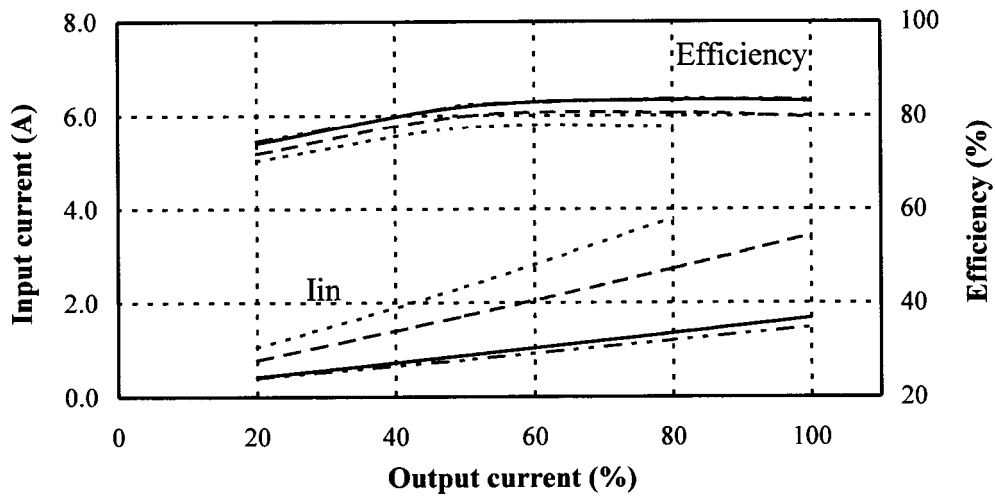

24V

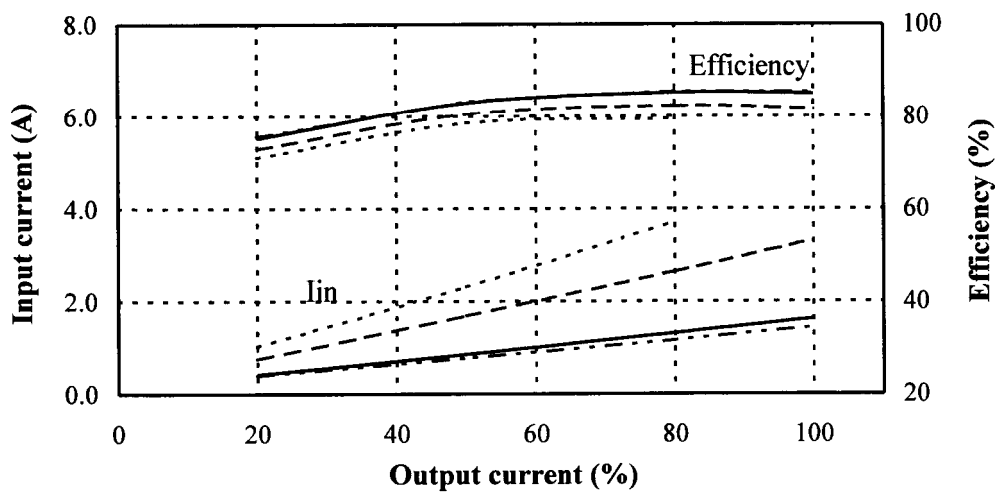

(4) Power factor and input current vs. output current Conditions: V_{in} : 85VAC -----
 : 115VAC - - - - -
 : 230VAC ————
 : 265VAC - · - · -
 T_a : 25°C

5V

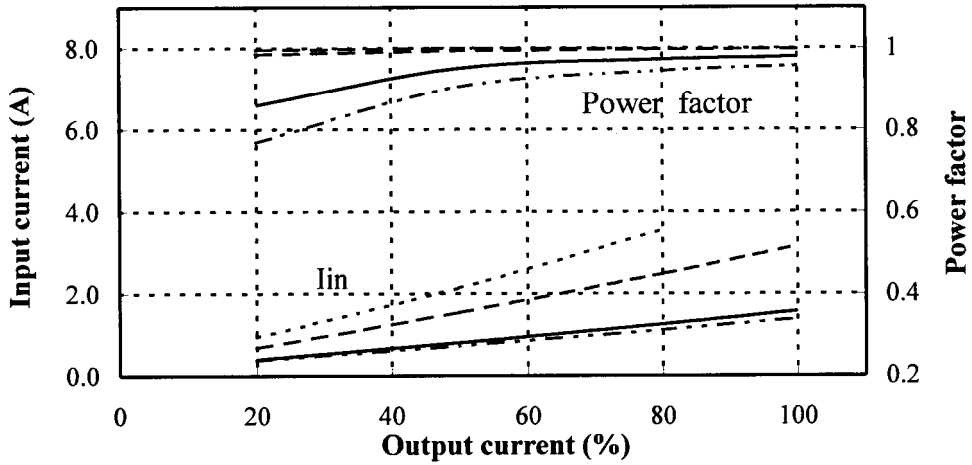

12V

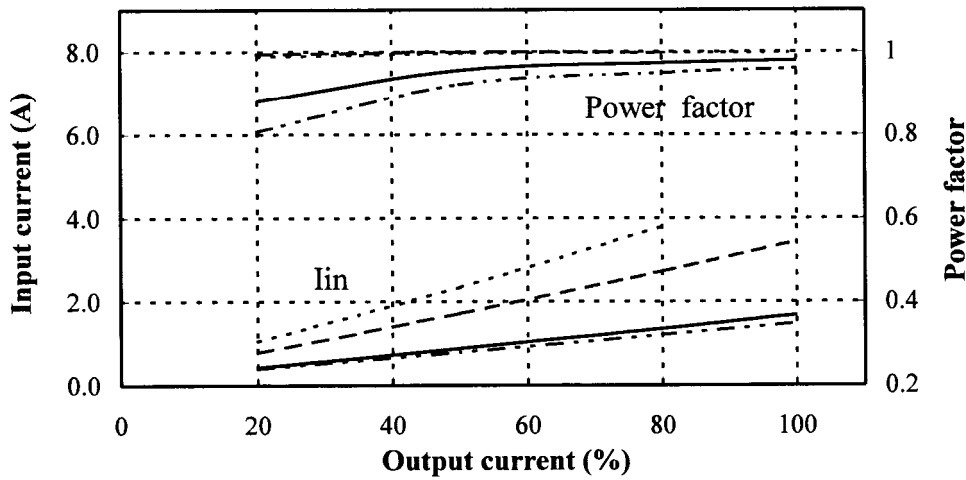

24V

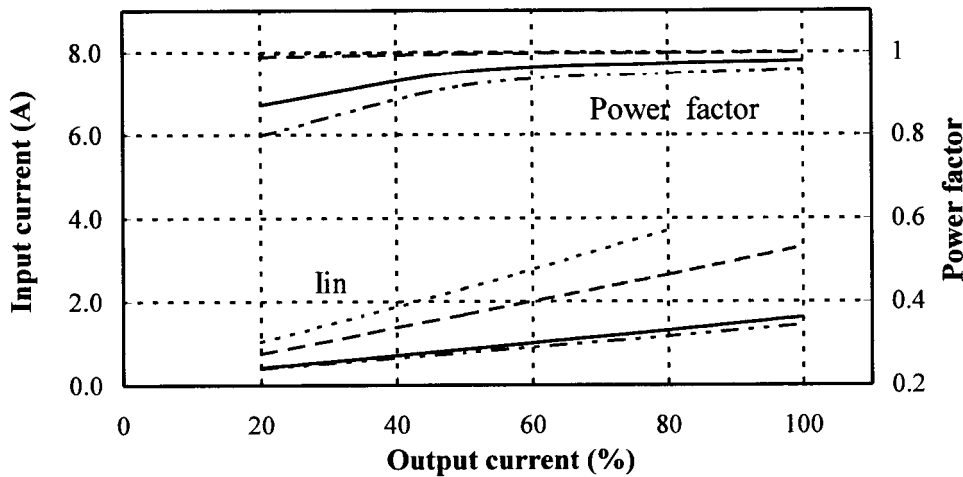

2.2 Warm up voltage drift characteristics

Conditions: V_{in} : 115VAC
 I_{out} : 100%
 T_a : 25°C

5V

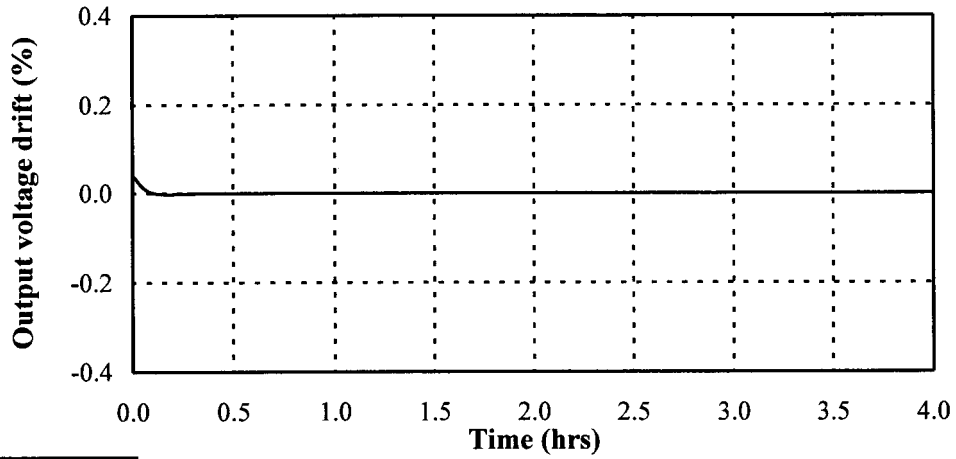

12V

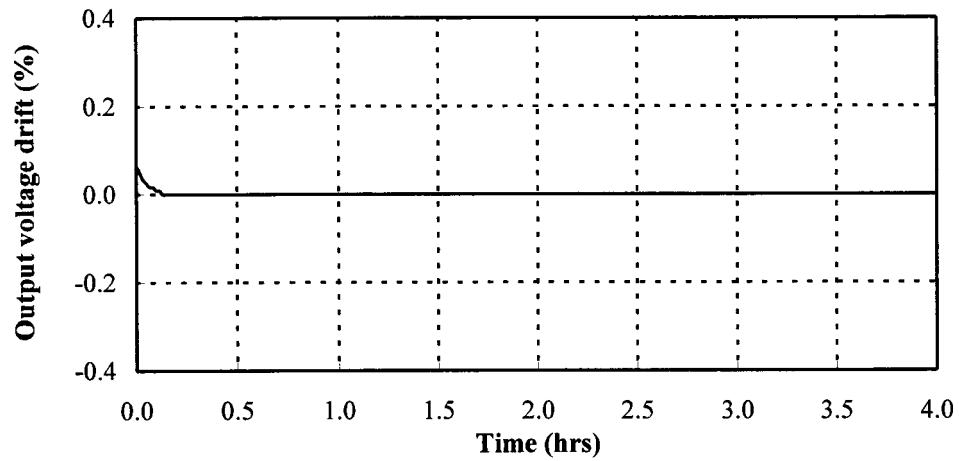

24V

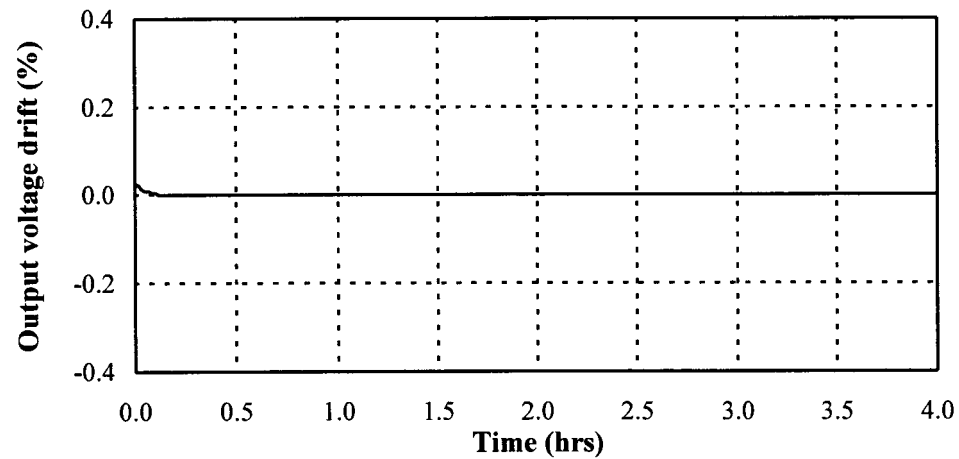

2.3 Over current protection (OCP) characteristics

Conditions: Vin : 85 VAC -----
 115 VAC -.-.-.-.-
 230 VAC —————
 265 VAC -.-.-.-.-
 Ta : 25°C

5V

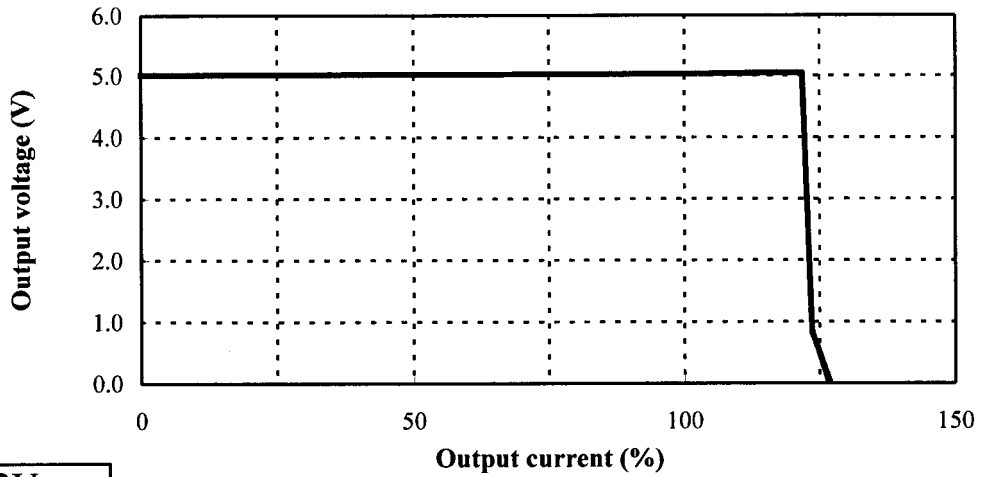

12V

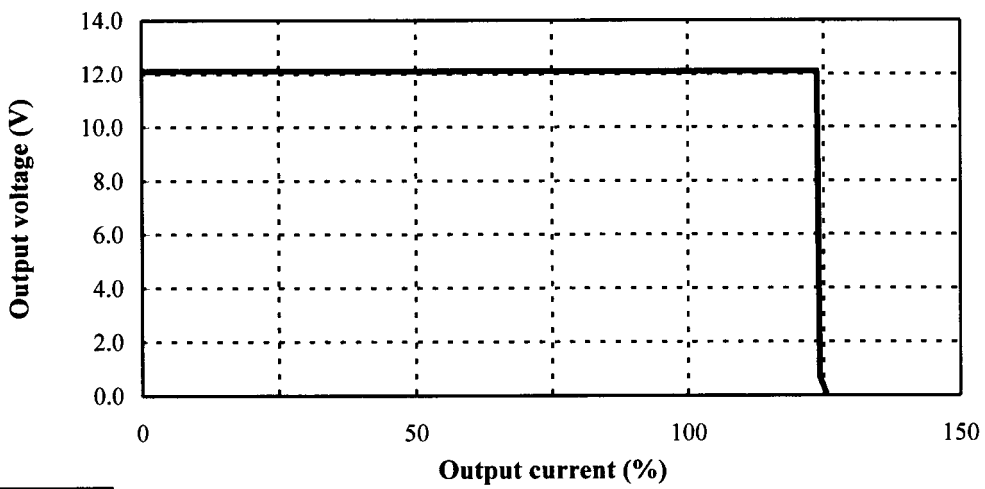

24V

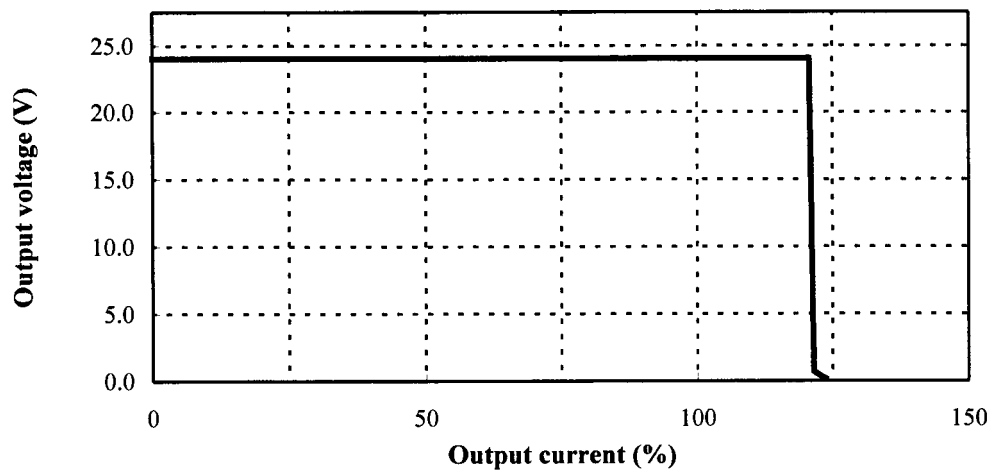

2.3 Over current protection (OCP) characteristics

Conditions: Vin : 115VAC

Ta : -10°C -----
25°C
50°C ———

5V

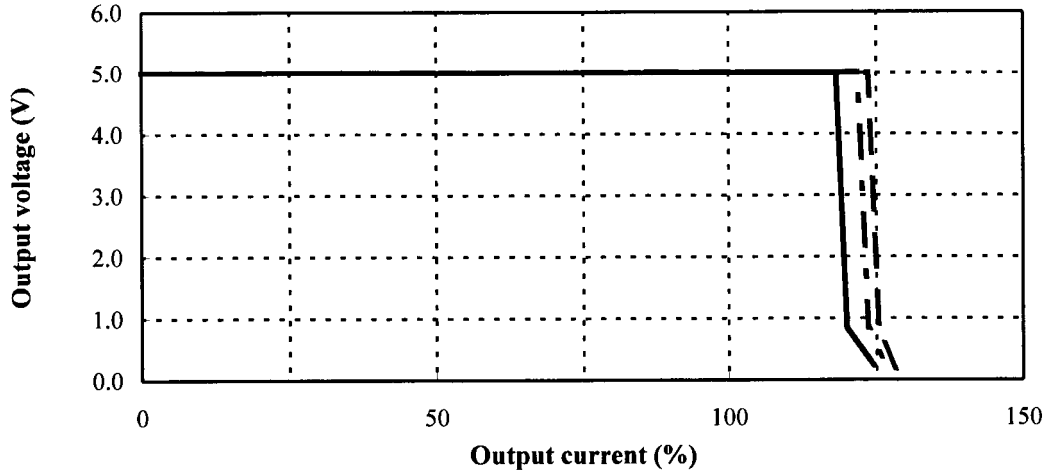

12V

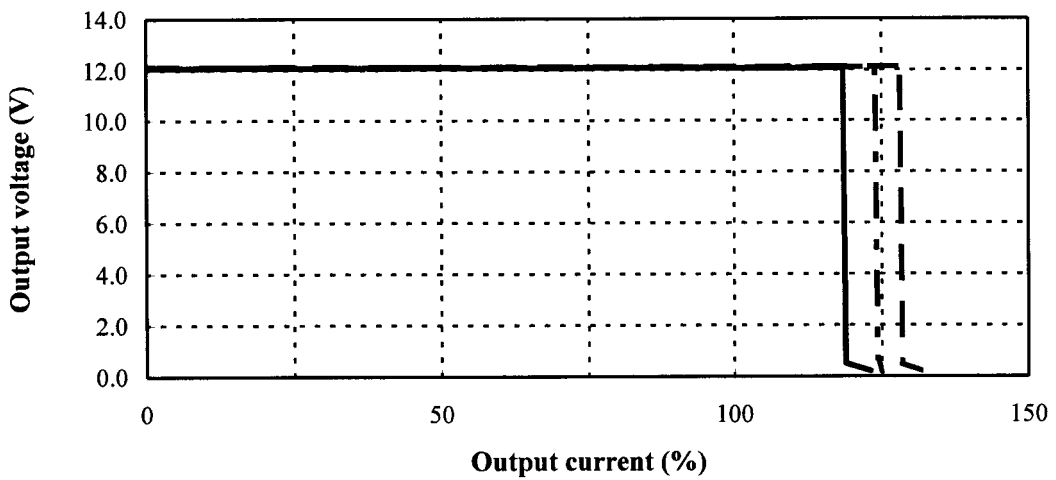

24V

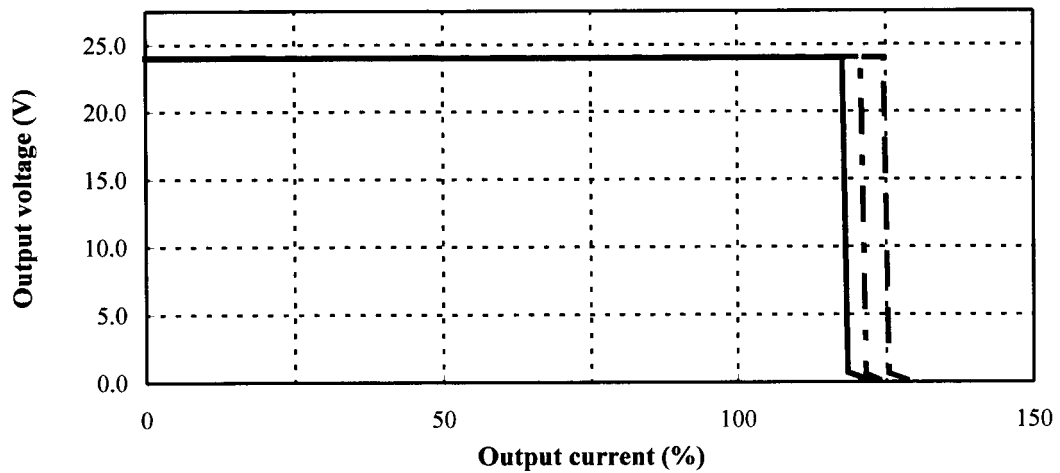

2.4 Over voltage protection (OVP) characteristics

Conditions: V_{in} : 115VAC

I_{out} : 0%

T_a : 25°C

5V

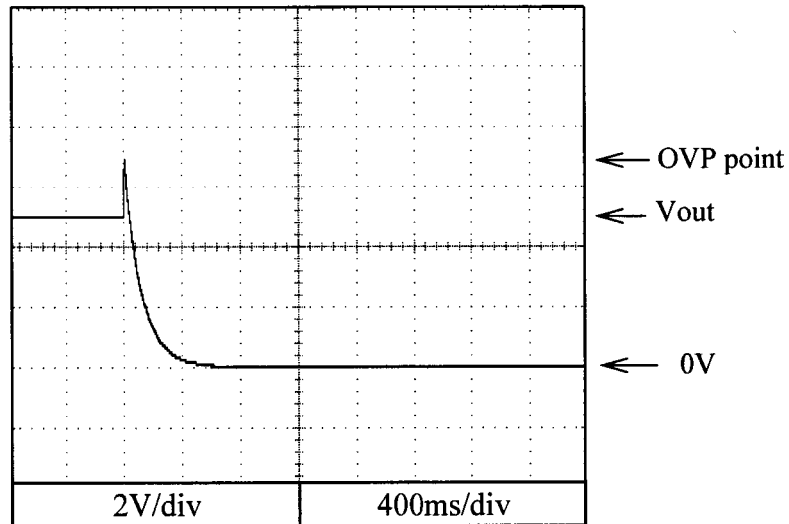

12V

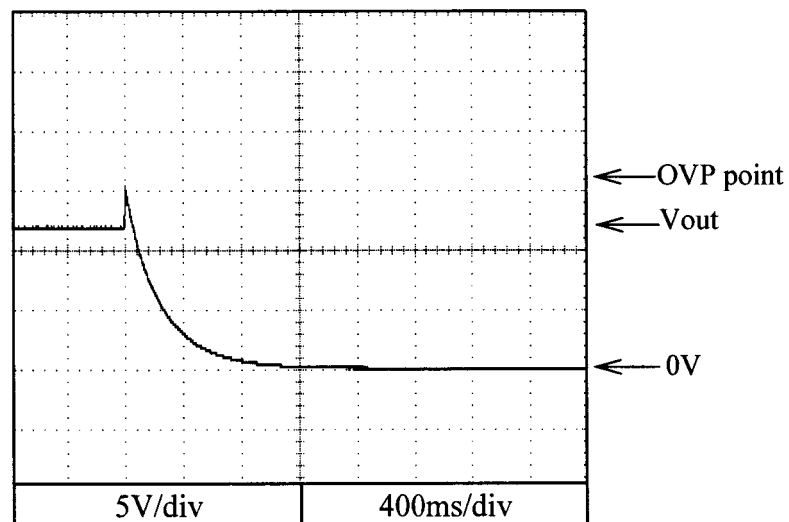

24V

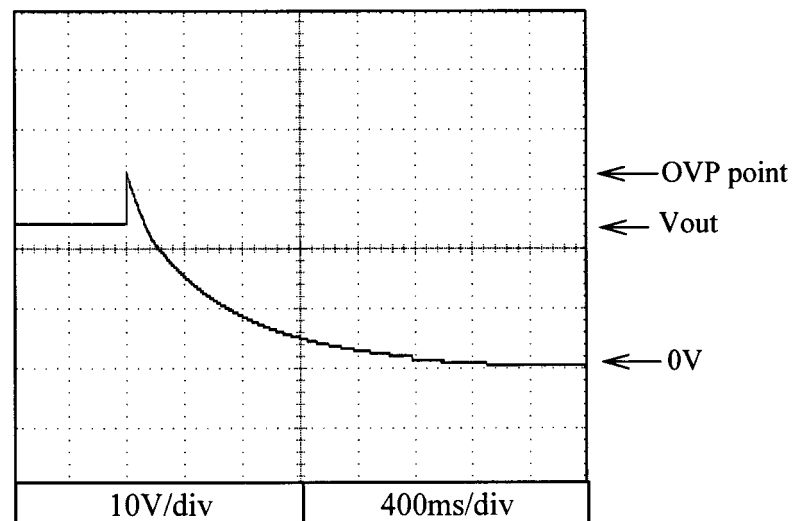

2.5 Output rise characteristics

Conditions: V_{in} : 85VAC (A)
 : 115VAC (B)
 : 230VAC (C)
 : 265VAC (D)
 I_{out} : 0%
 T_a : 25°C

5V

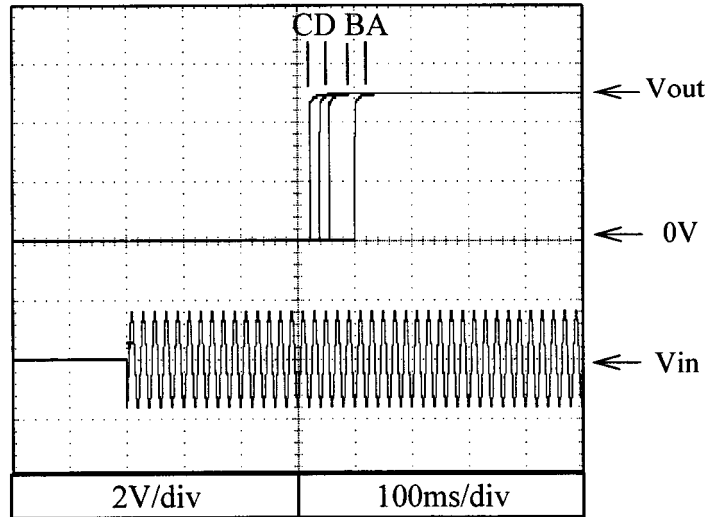

12V

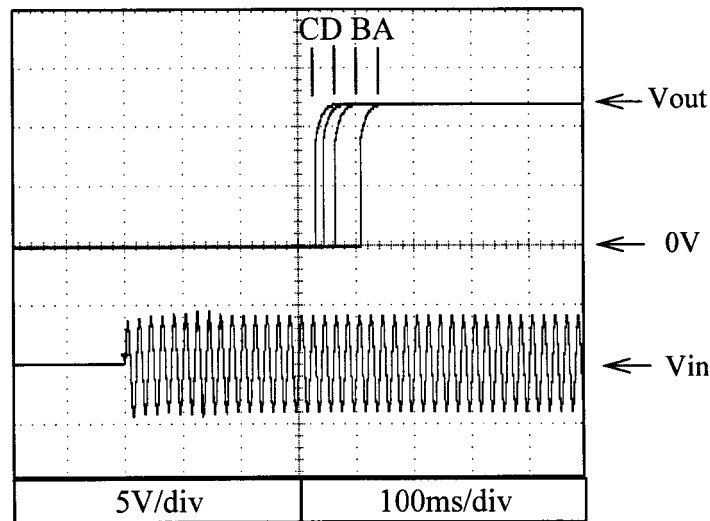

24V

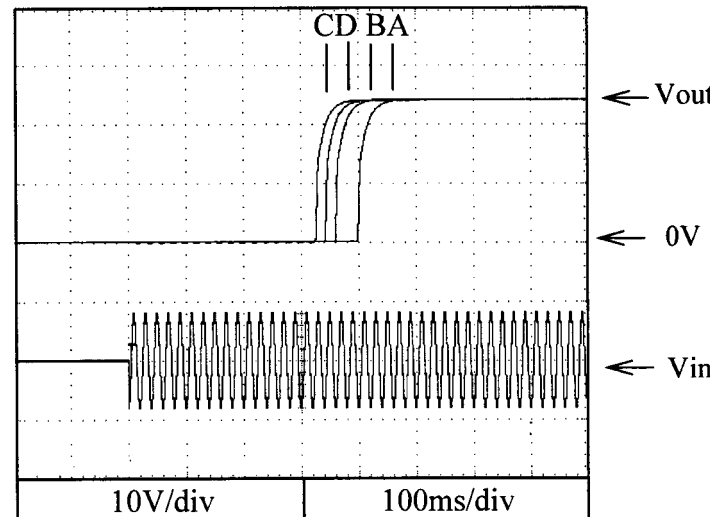

2.5 Output rise characteristics

Conditions: V_{in}

: 85VAC (A)

: 115VAC (B)

: 230VAC (C)

: 265VAC (D)

T_a : 25°C

I_{out}

(A) : 80%

(B,C,D) : 100%

5V

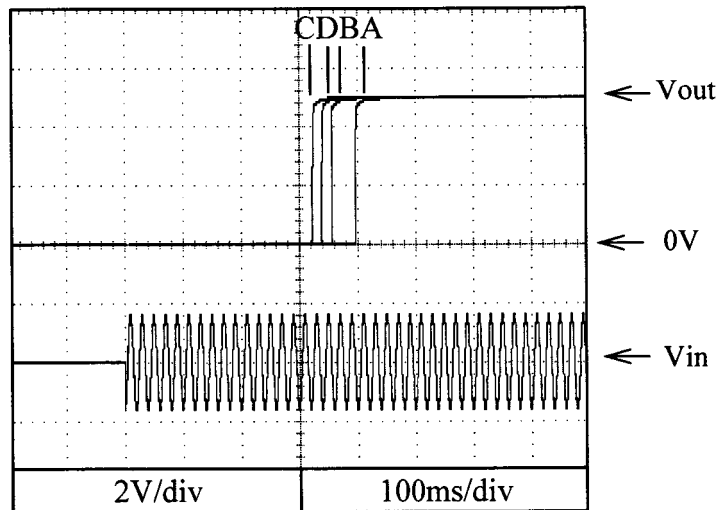

12V

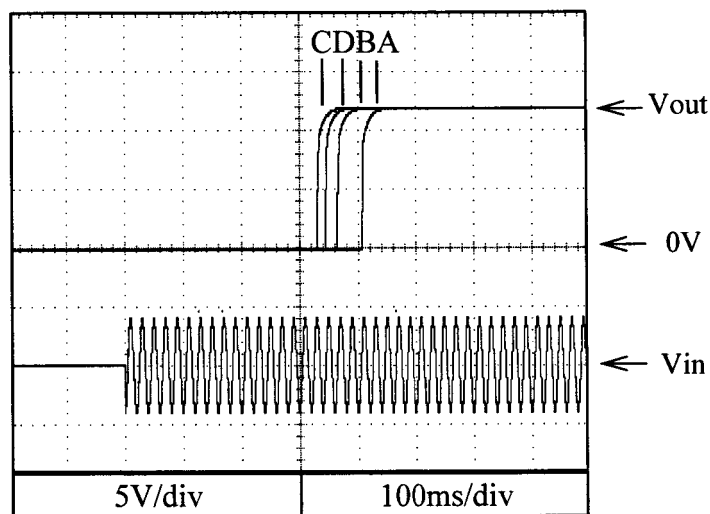

24V

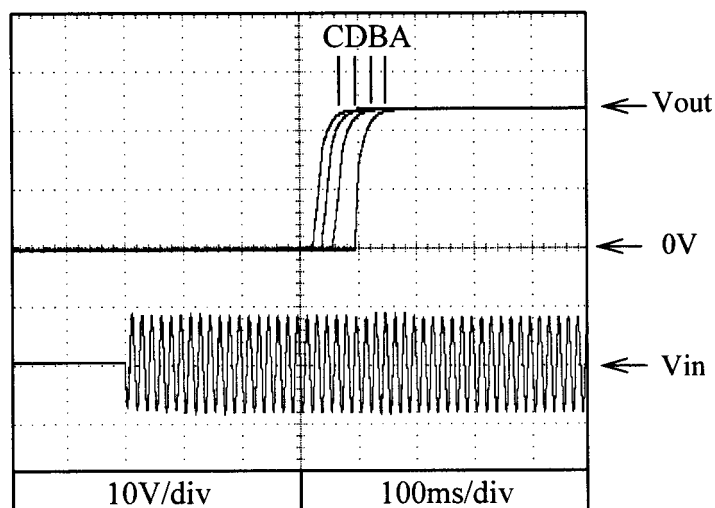

2.6 Output fall characteristics

Conditions: Vin : 85VAC (A)
 : 115VAC (B)
 : 230VAC (C)
 : 265VAC (D)
 Iout : 0%
 Ta : 25°C

5V

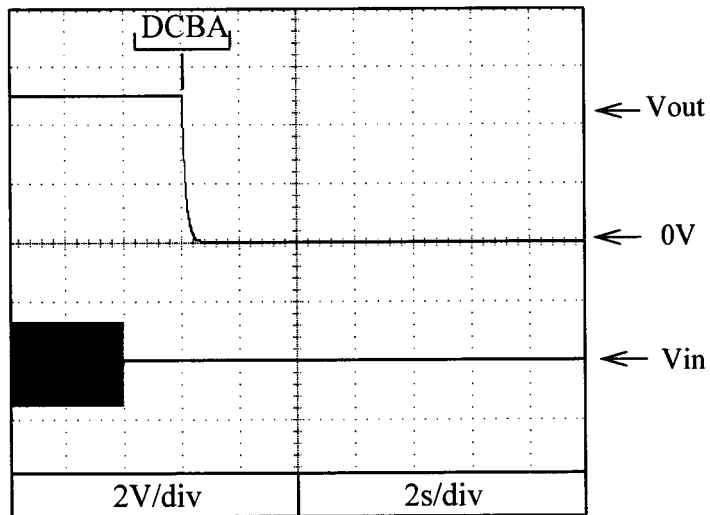

12V

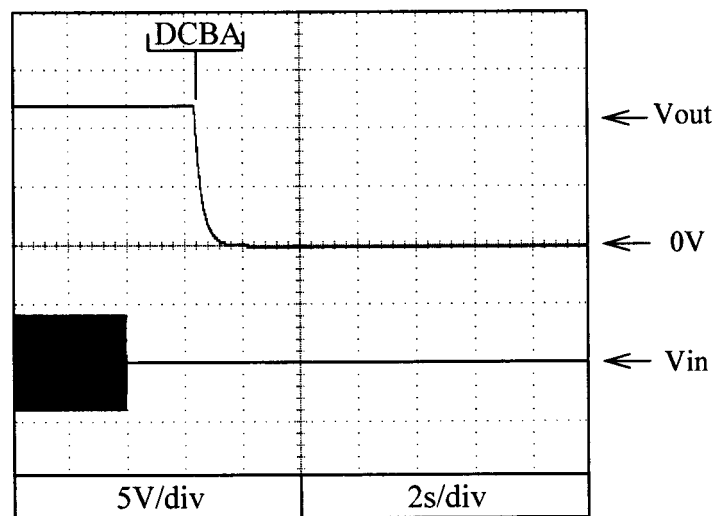

24V

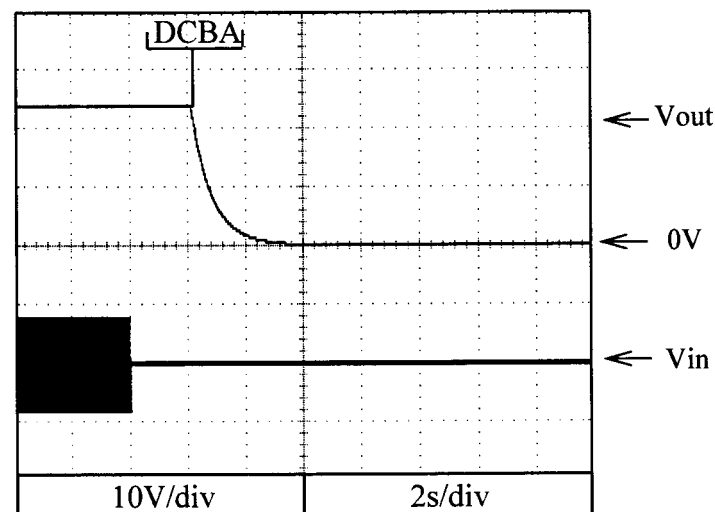

2.6 Output fall characteristics

Conditions: V_{in}

- : 85VAC (A)
- : 115VAC (B)
- : 230VAC (C)
- : 265VAC (D)

I_{out}

- (A): 80%
- (B,C,D): 100%

T_a : 25°C

5V

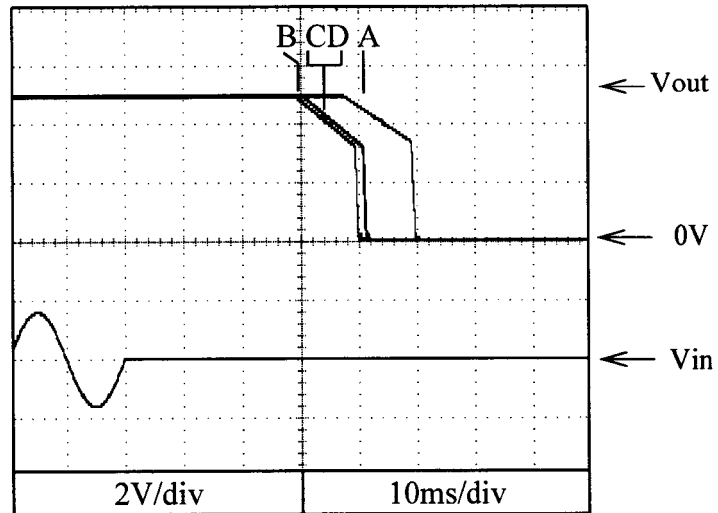

12V

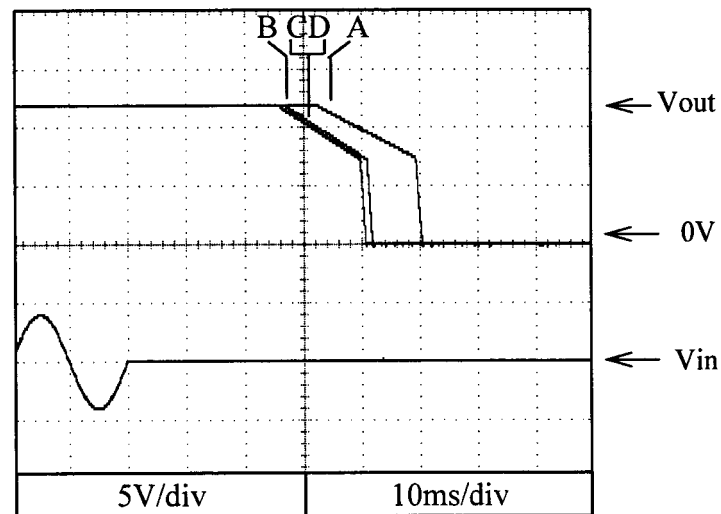

24V

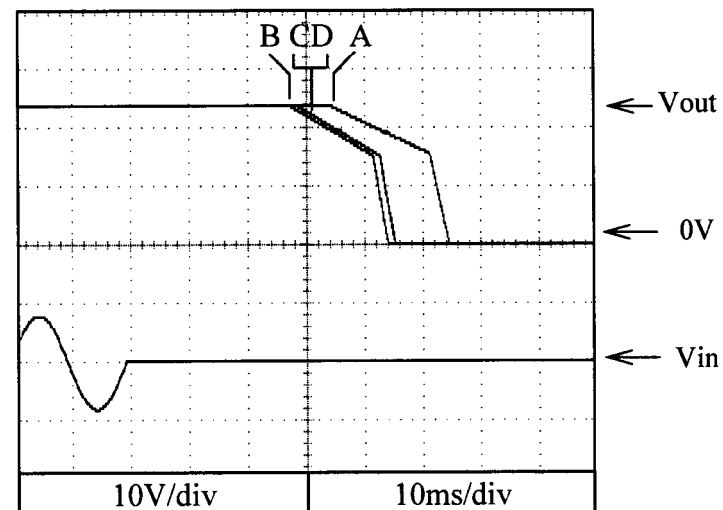

2.7 Hold up time characteristics

Conditions: V_{in} : 115VAC -----
 : 230VAC ————
 T_a : 25°C

5V

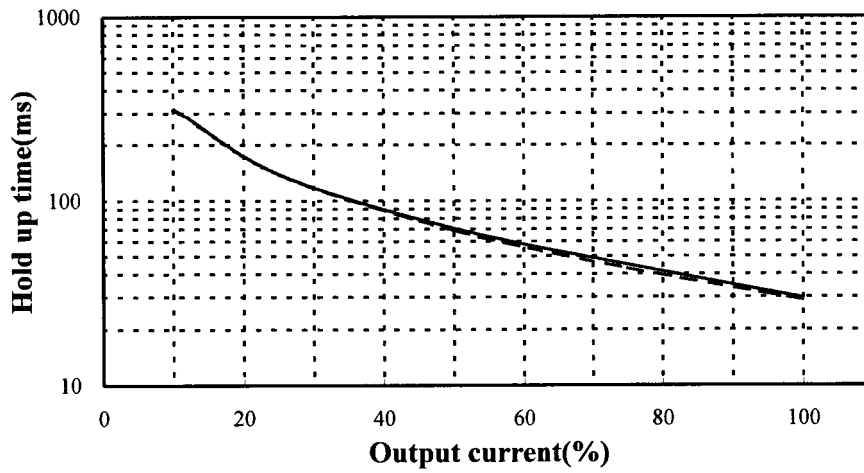

12V

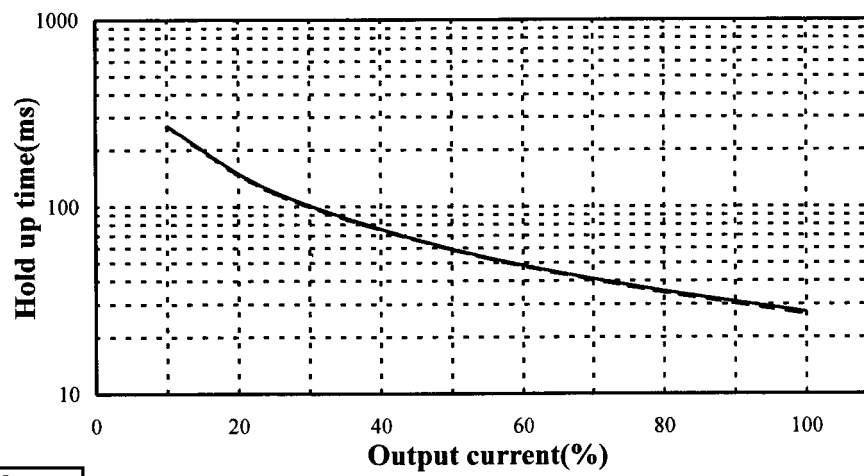

24V

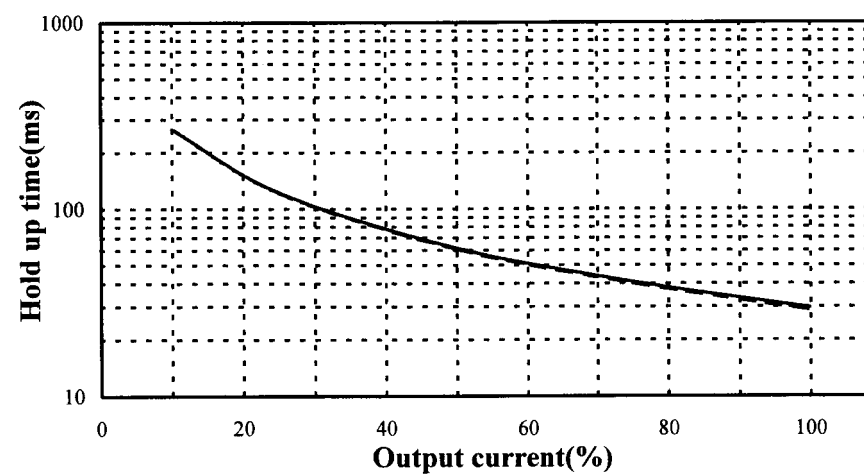

2.8 Dynamic line response characteristics

Conditions: V_{in} : 85VAC \leftrightarrow 132VAC(A)
170VAC \leftrightarrow 265VAC(B)
 I_{out} : 100%
 T_a : 25°C

5V

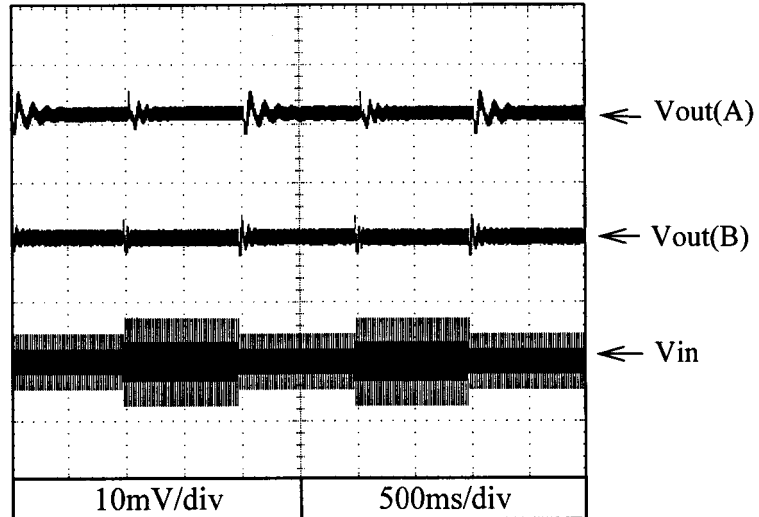

12V

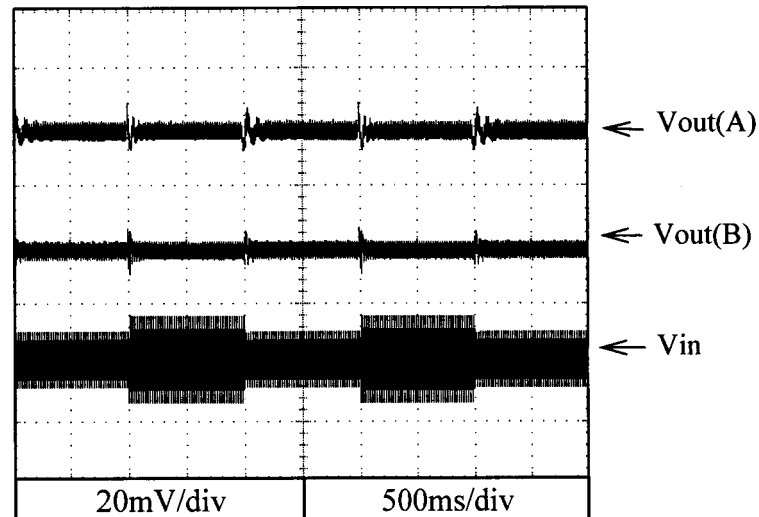

24V

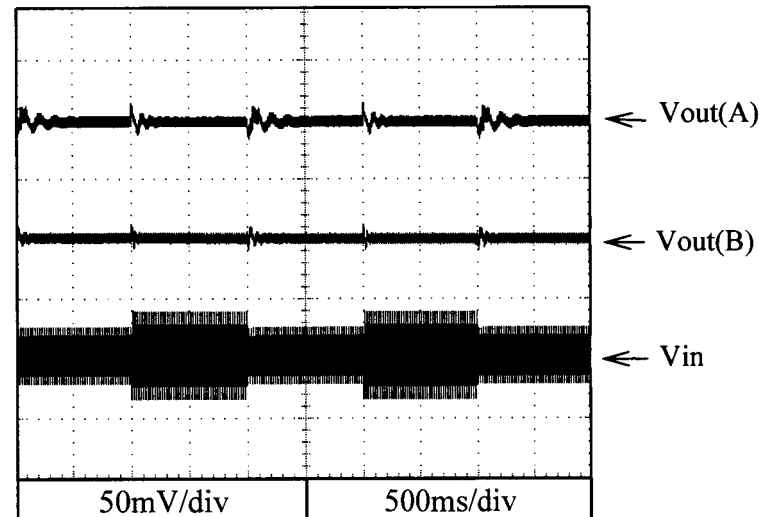

2.9 Dynamic load response characteristics

Conditions: V_{in} : 115VAC
 T_a : 25°C

5V

$f=100\text{Hz}$

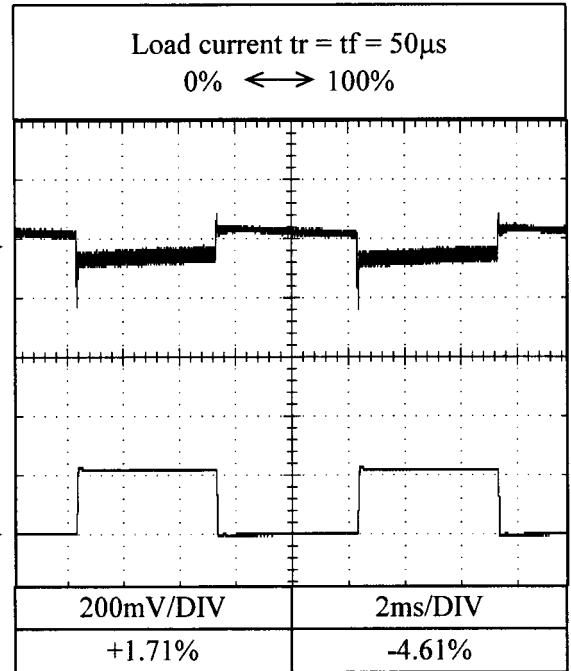
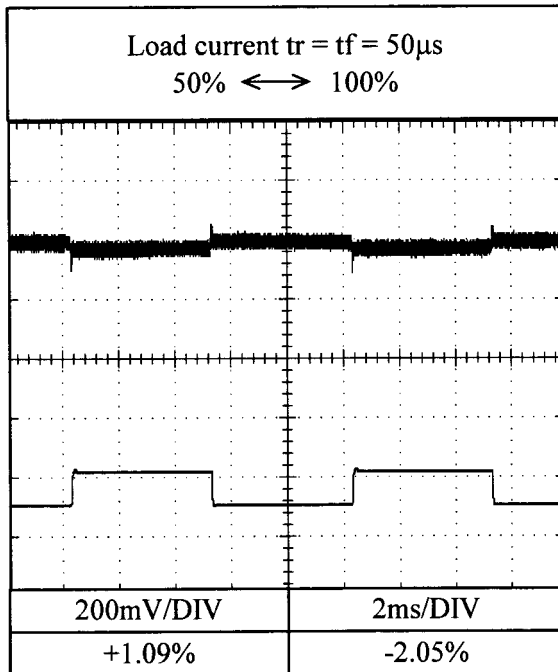

$f=1\text{kHz}$

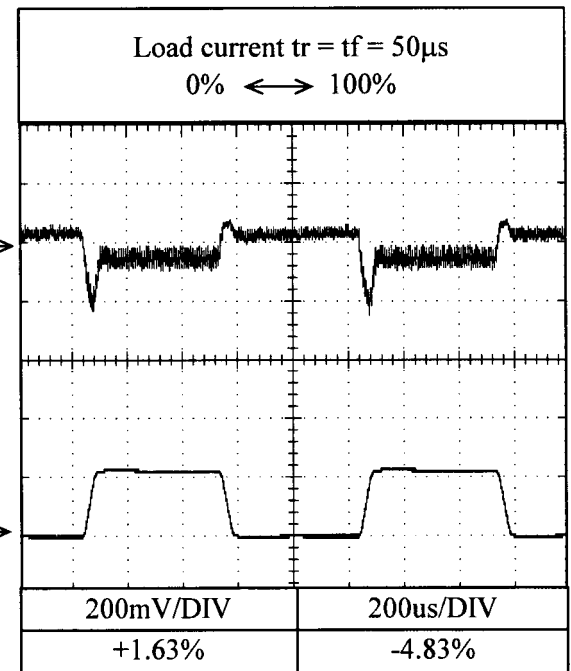
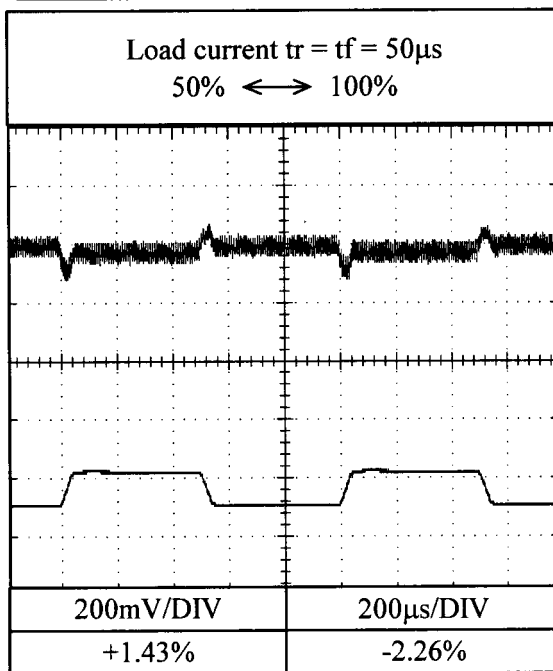

2.9 Dynamic load response characteristics

Conditions: V_{in} : 230VAC
 T_a : 25°C

5V

$f=100\text{Hz}$

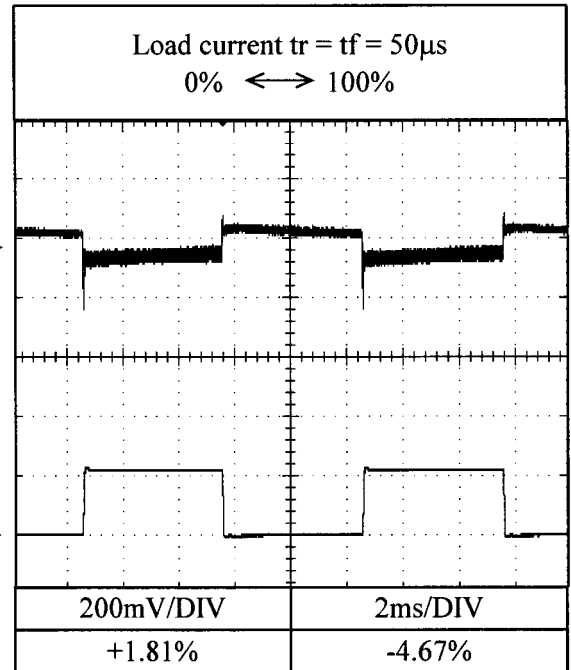
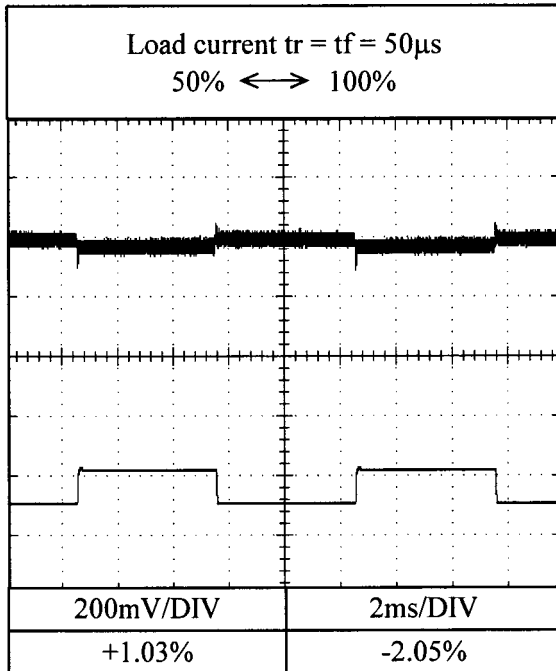

$f=1\text{kHz}$

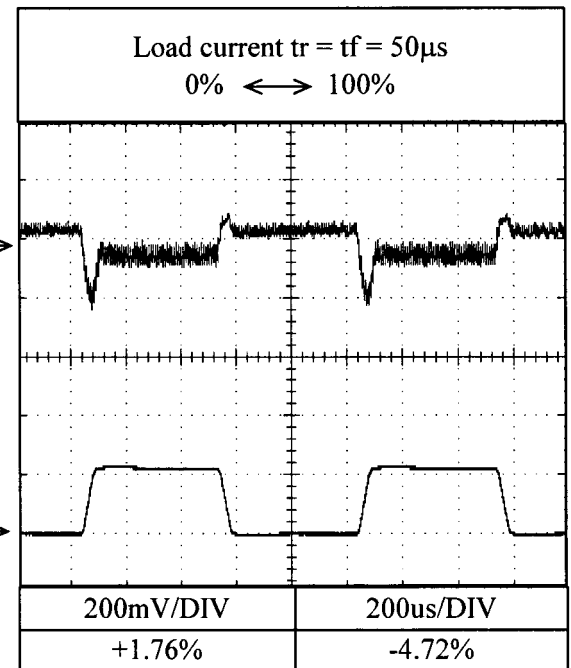
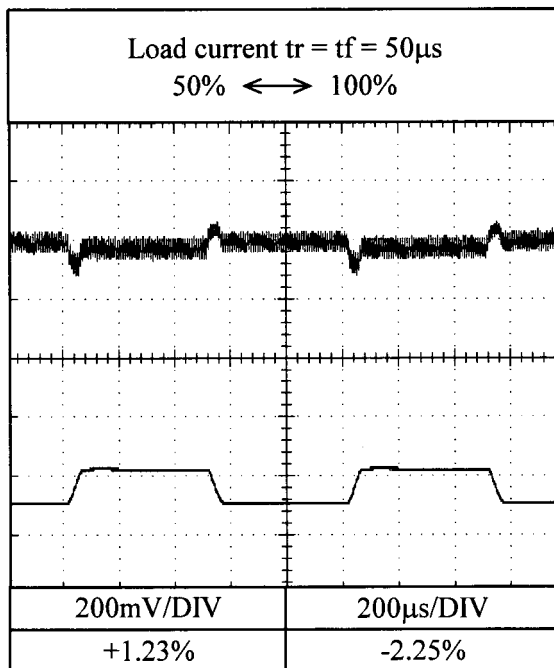

2.9 Dynamic load response characteristics

Conditions: V_{in} : 115VAC
 T_a : 25°C

12V

f=100Hz

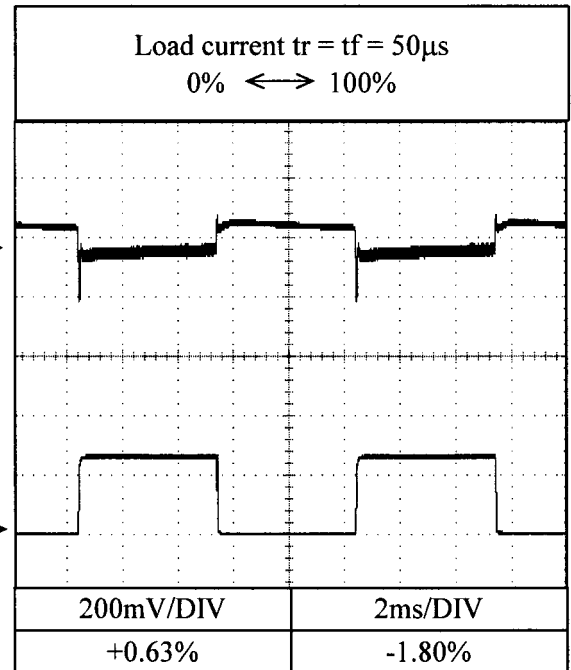
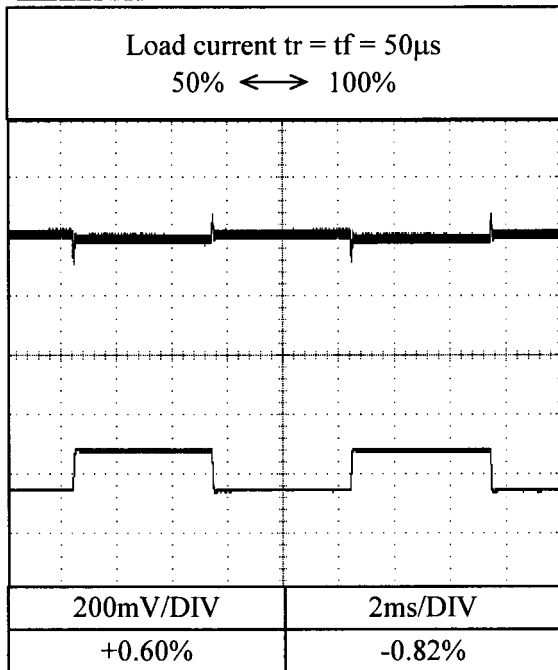

f=1kHz

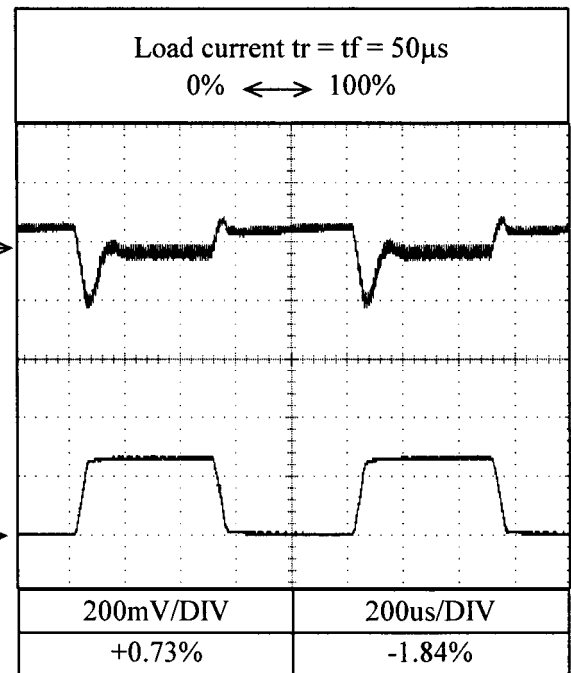
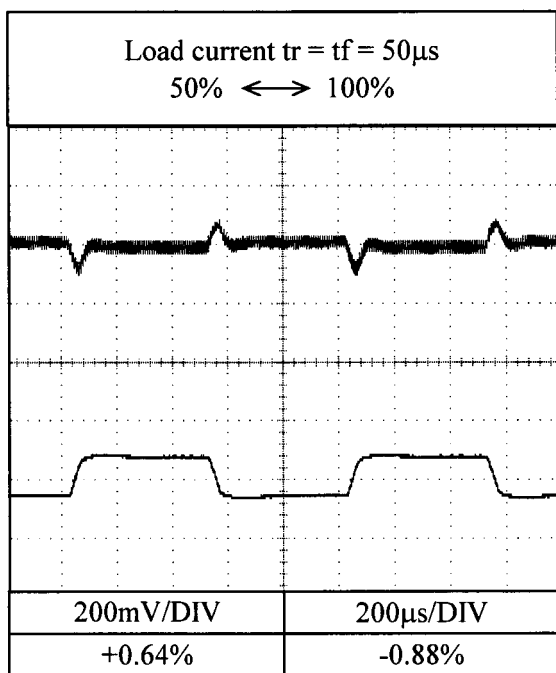

2.9 Dynamic load response characteristics

Conditions: V_{in} : 230VAC
 T_a : 25°C

12V

f=100Hz

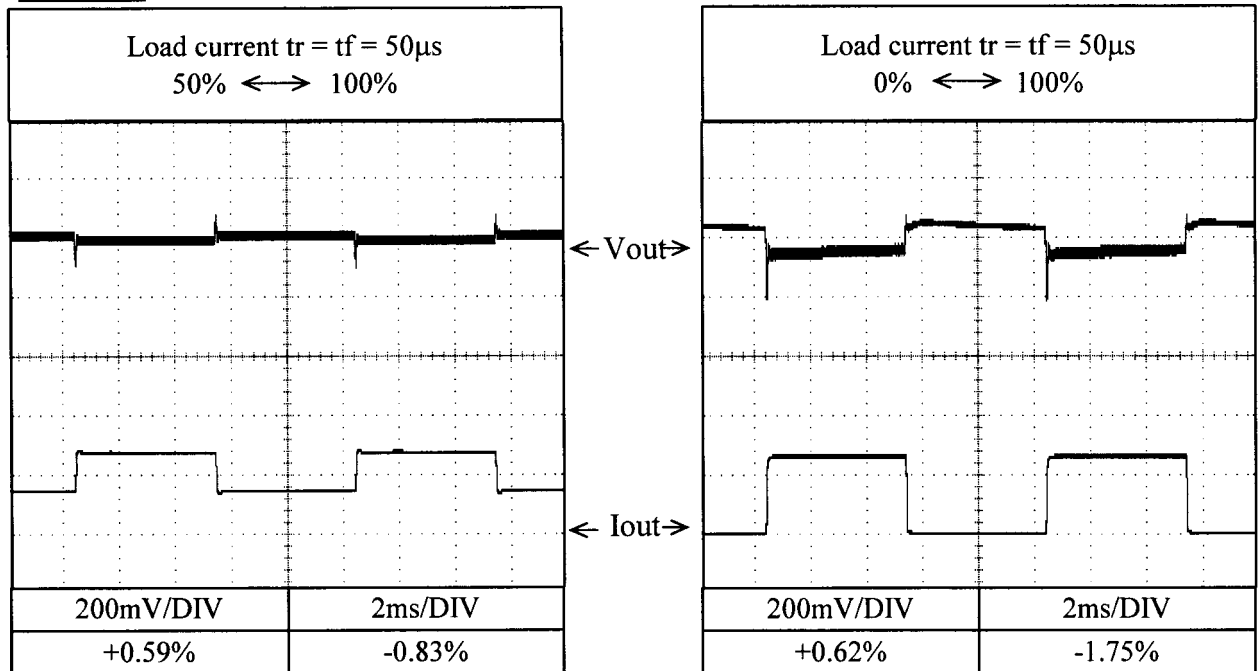

f=1kHz

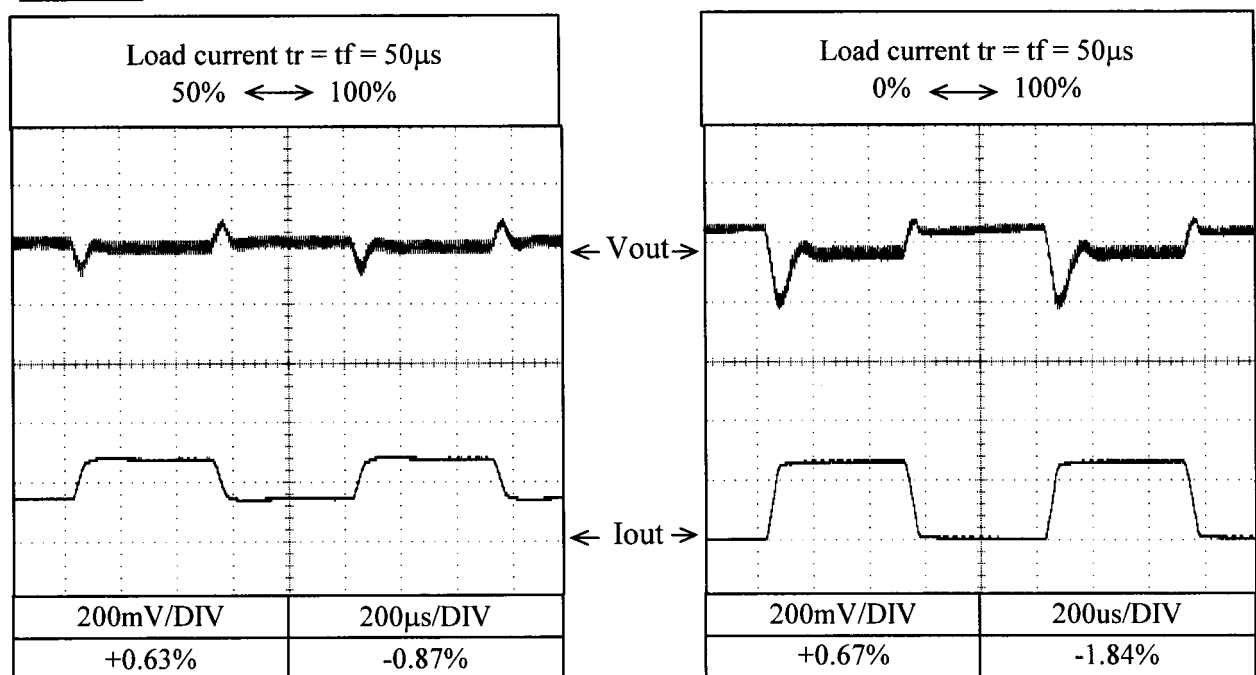

2.9 Dynamic load response characteristics

Conditions: V_{in} : 115VAC
 T_a : 25°C

24V

f=100Hz

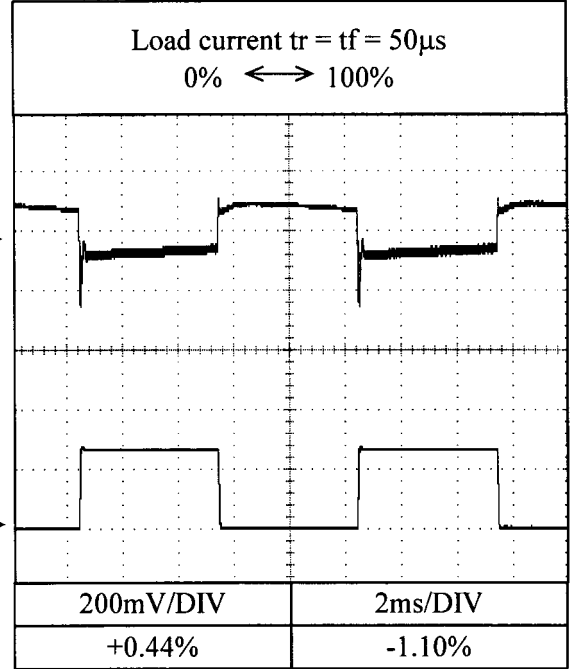
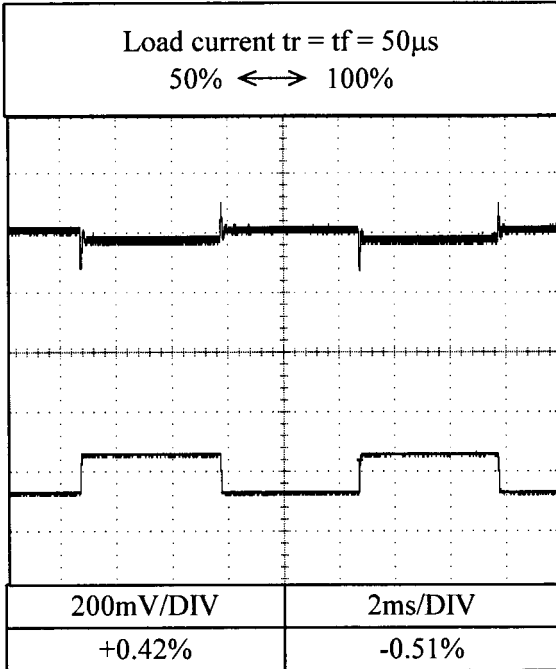

f=1kHz

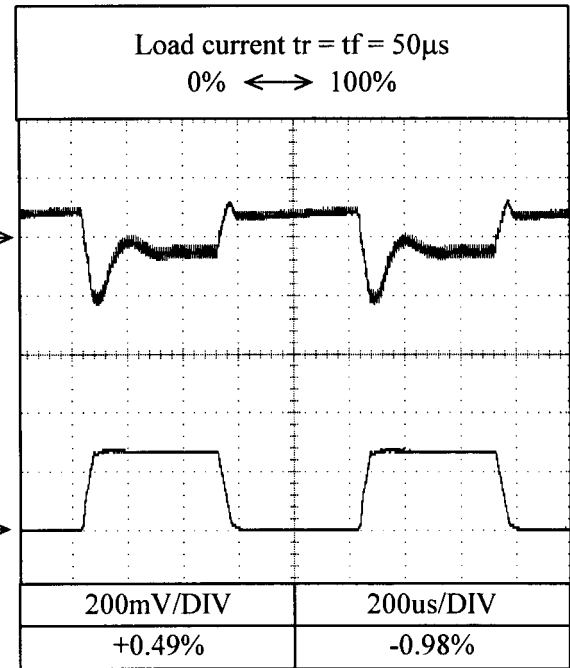
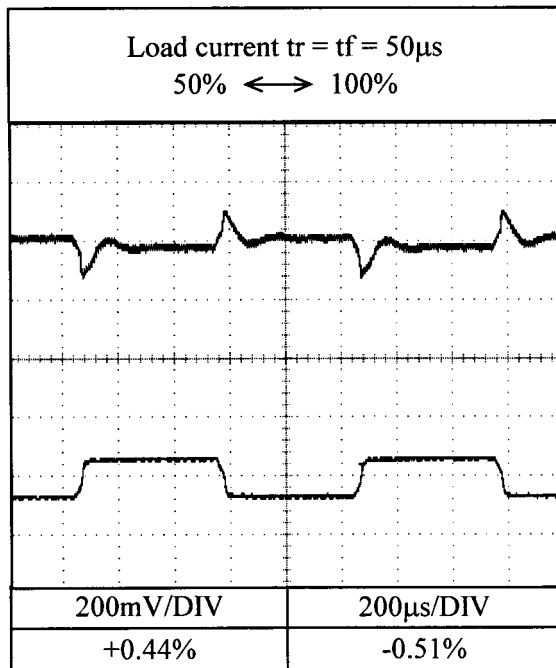

2.9 Dynamic load response characteristics

Conditions: V_{in} : 230VAC
 T_a : 25°C

24V

$f=100\text{Hz}$

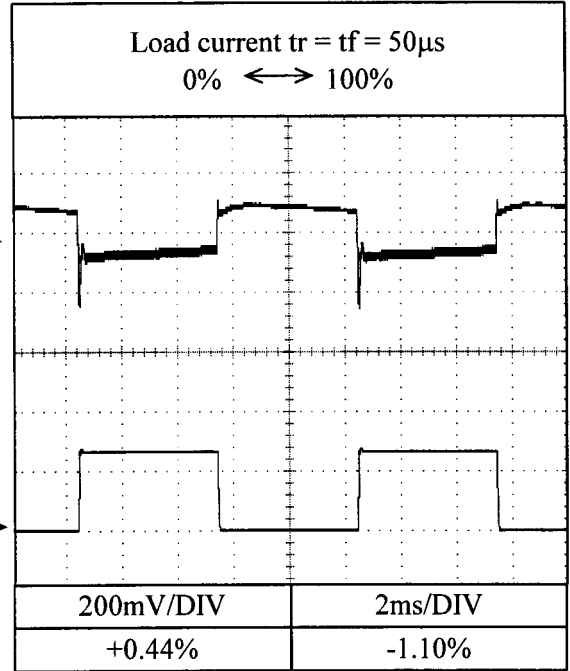
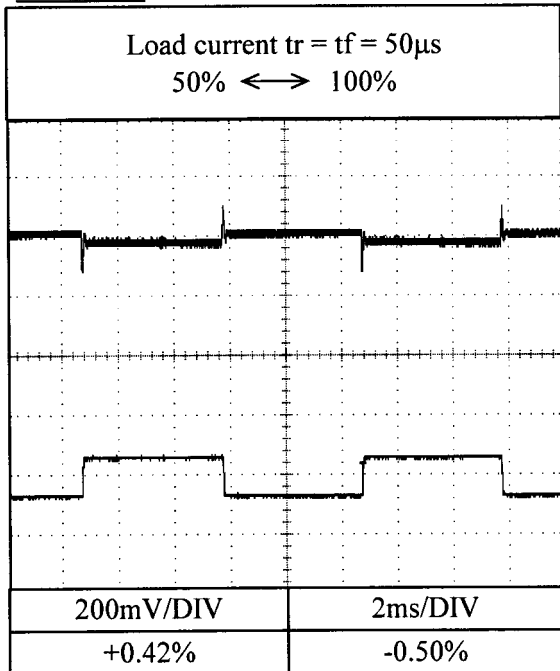

$f=1\text{kHz}$

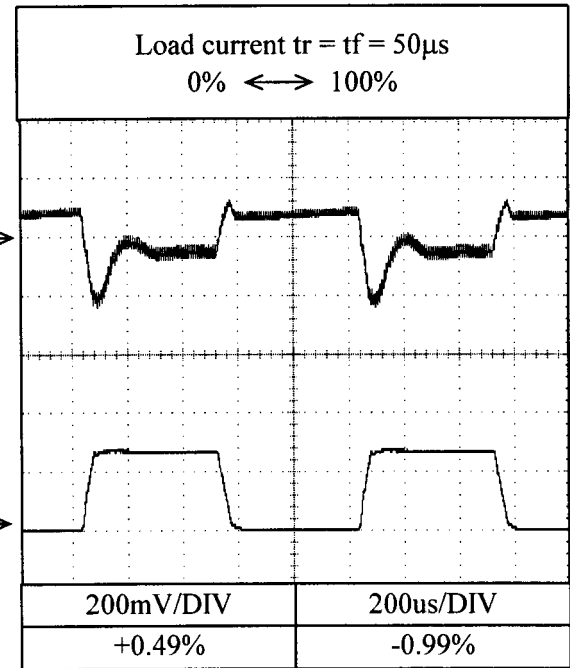
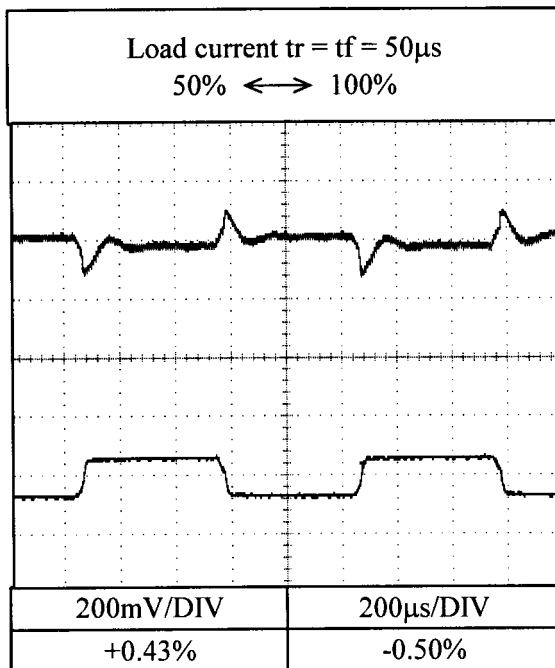

2.10 Response to brownout characteristics

Conditions: Vin : 115VAC
Iout : 100%
Ta : 25°C

5V

A=26ms
B=27ms
C=39ms
D=40ms

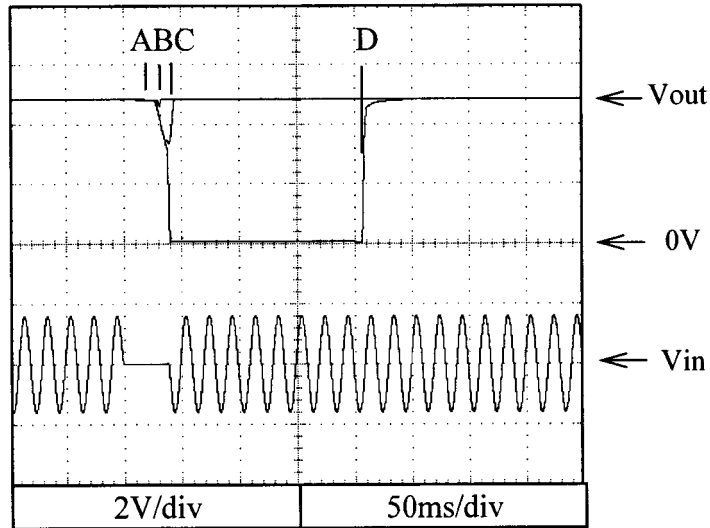

12V

A=26ms
B=27ms
C=39ms
D=40ms

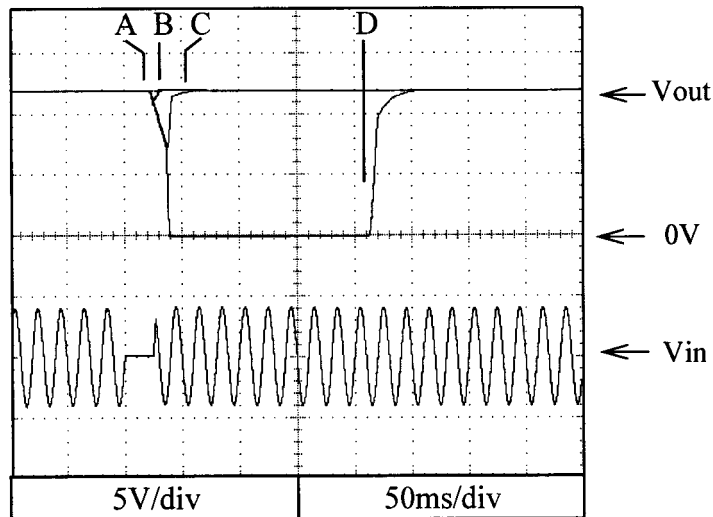

24V

A=27ms
B=28ms
C=39ms
D=40ms

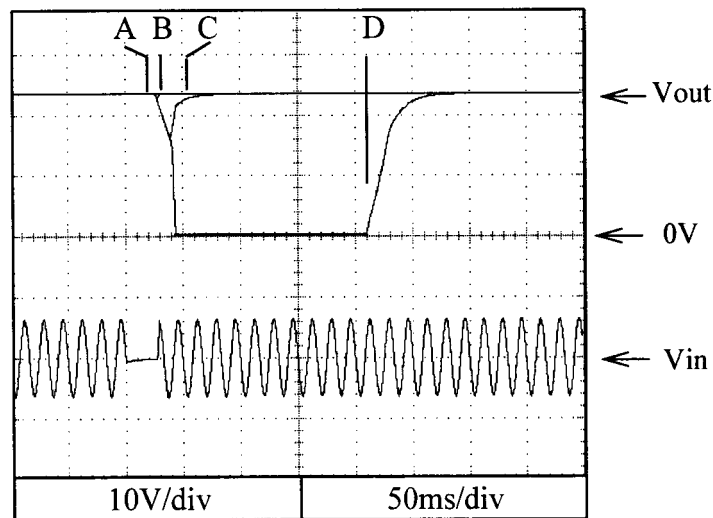

2.10 Response to brownout characteristics

Conditions: Vin : 230VAC
Iout : 100%
Ta : 25°C

5V

A=28ms
B=29ms
C=42ms
D=43ms

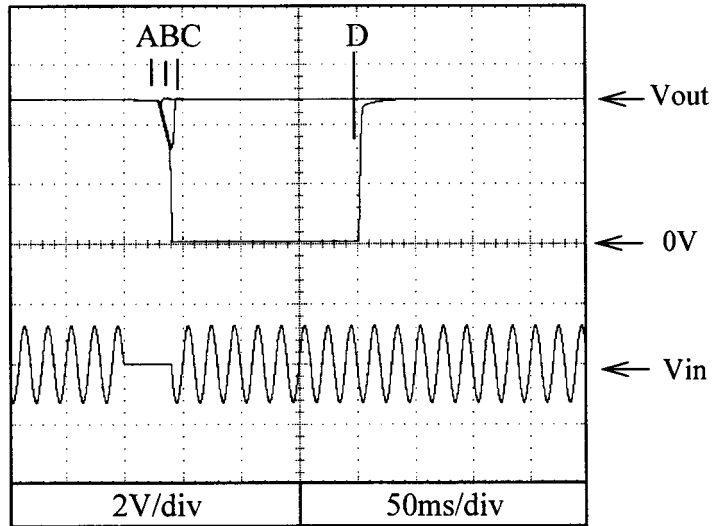

12V

A=28ms
B=29ms
C=41ms
D=42ms

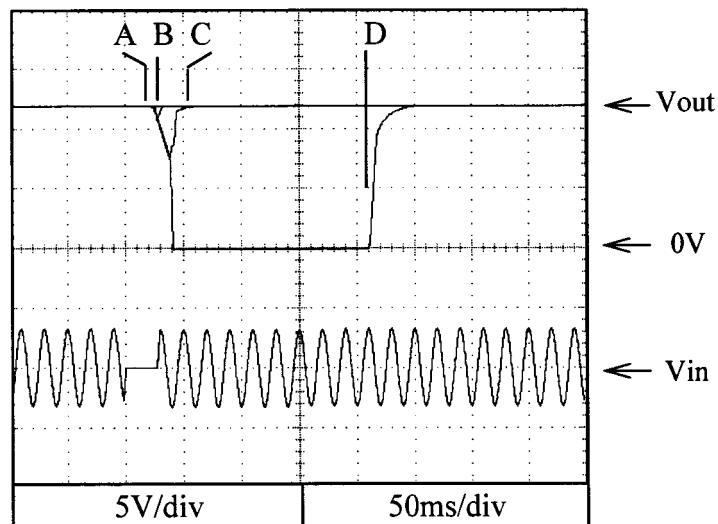

24V

A=28ms
B=29ms
C=41ms
D=42ms

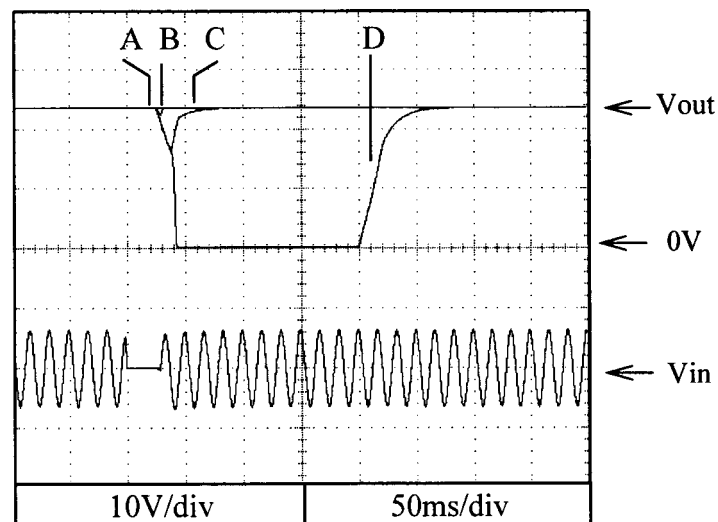

2.11 Inrush current waveform

Conditions: Vin : 115VAC
Iout : 100%
Ta : 25°C

5V

Switch on phase angle
of input AC voltage
 $\phi = 0^\circ$

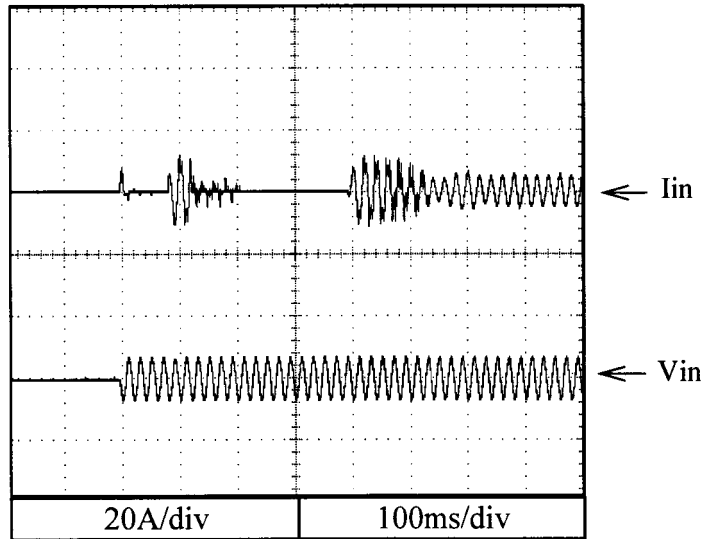

Switch on phase angle
of input AC voltage
 $\phi = 90^\circ$

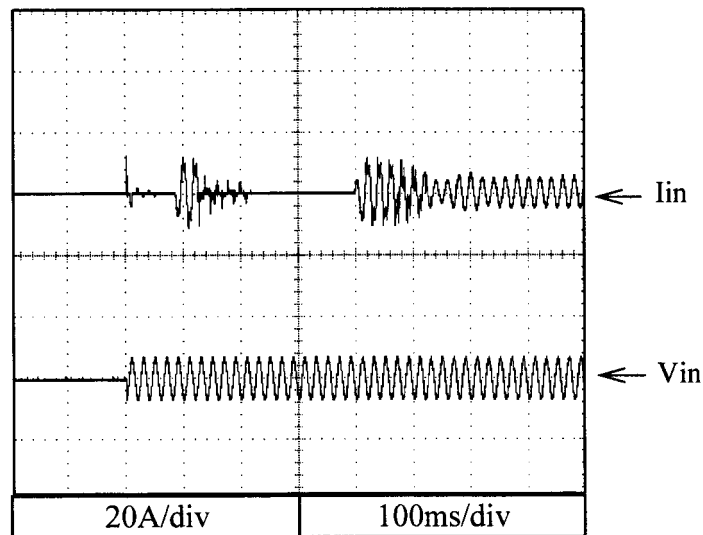

2.11 Inrush current waveform

Conditions: V_{in} : 230VAC
 I_{out} : 100%
 T_a : 25°C

5V

Switch on phase angle
of input AC voltage
 $\phi = 0^\circ$

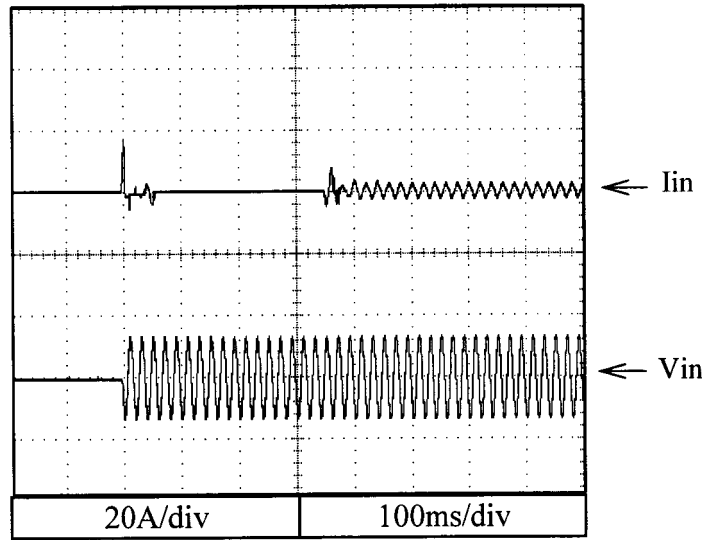

Switch on phase angle
of input AC voltage
 $\phi = 90^\circ$

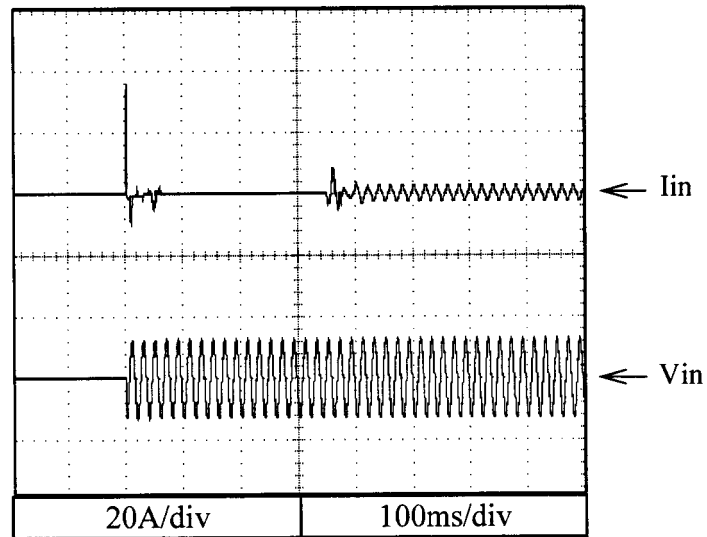

2.12 Input current waveform

Conditions: Iout : 100%
Ta : 25°C

5V

Vin : 115VAC

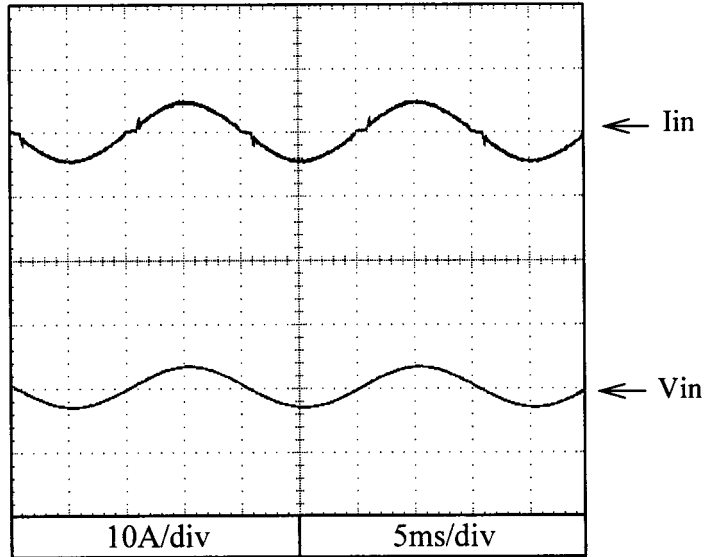

Vin : 230VAC

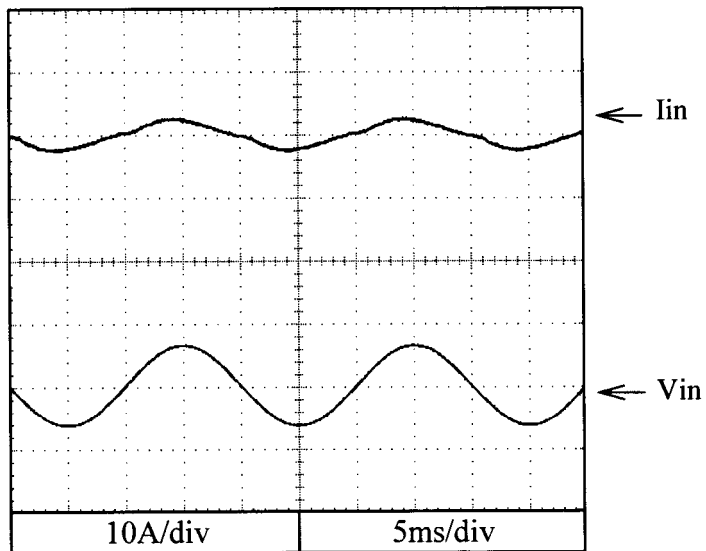

2.13 Input current harmonics

Conditions: Vin : 115VAC
Iout : 100%
Ta : 25°C

5V

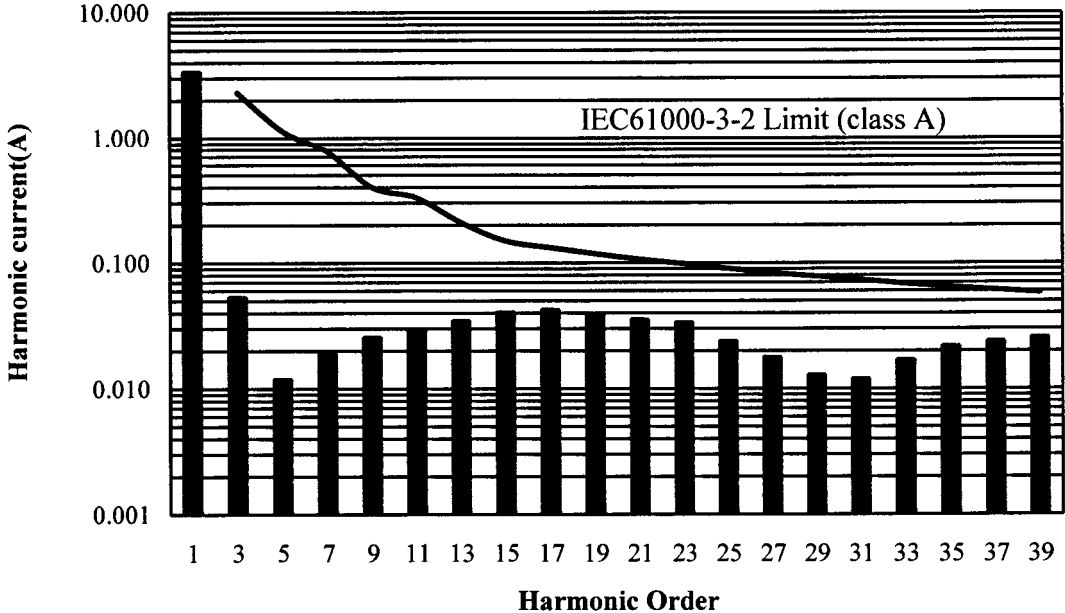

Conditions: Vin : 230VAC
Iout : 100%
Ta : 25°C

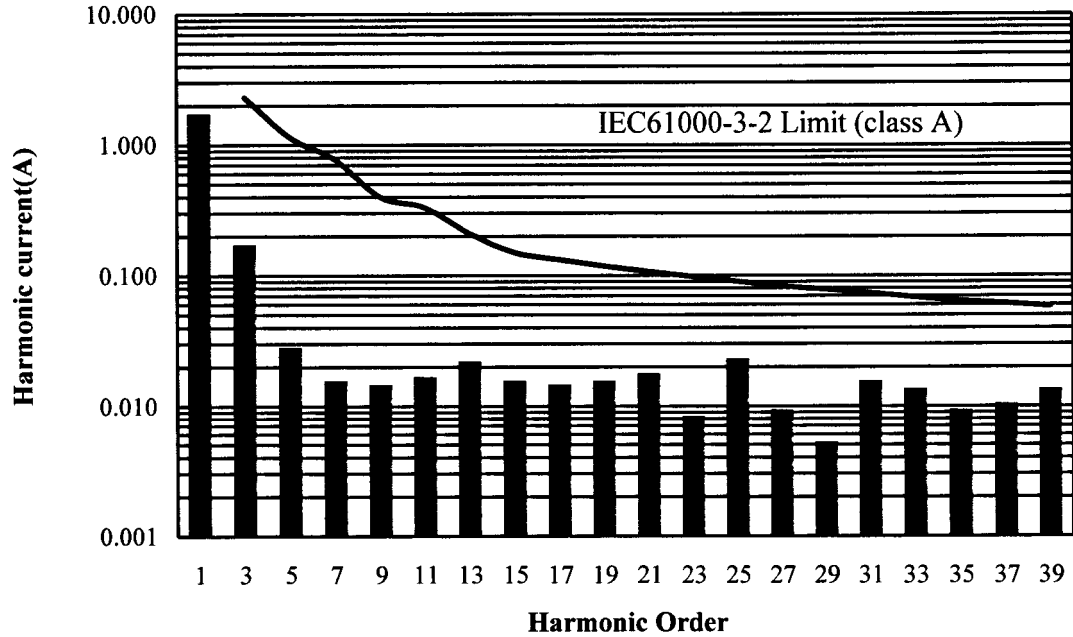

2.14 Leakage current characteristics

Conditions: Iout : 0% -----
 : 100% ————
 Ta : 25°C
 f : 50Hz
 Equipment used : MODEL 228
 (Simpson)

5V

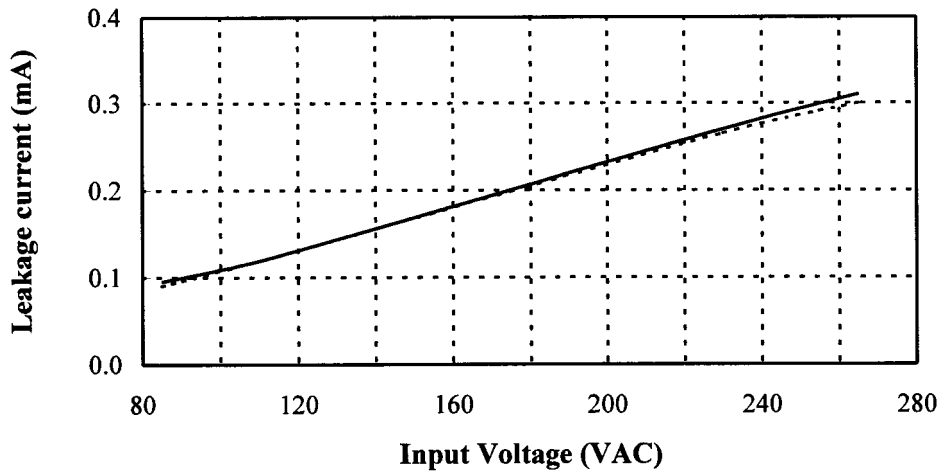

12V

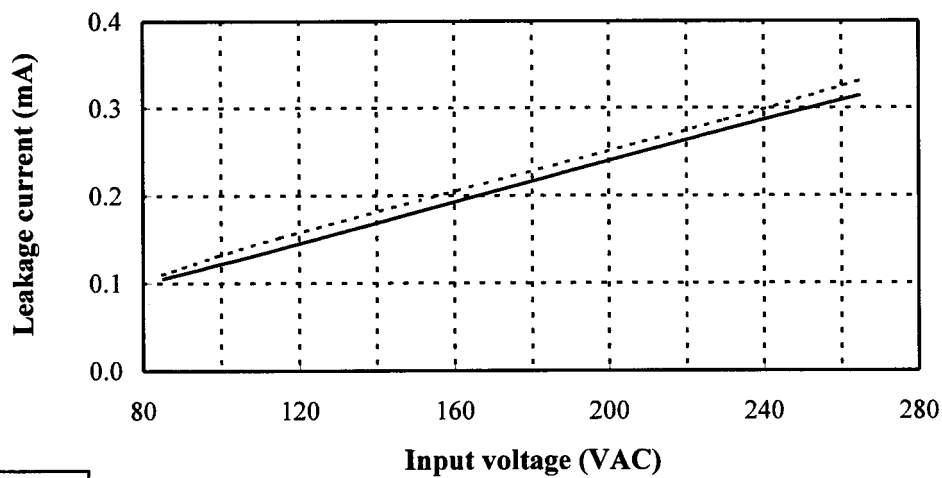

24V

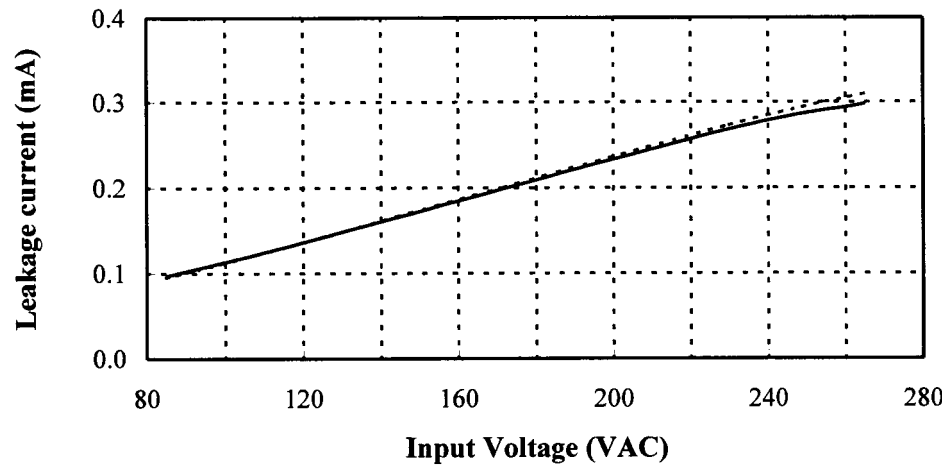

2.15 Output ripple and noise waveform

Conditions: V_{in} : 115VAC
 I_{out} : 100%
 T_a : 25°C

NORMAL MODE

5V

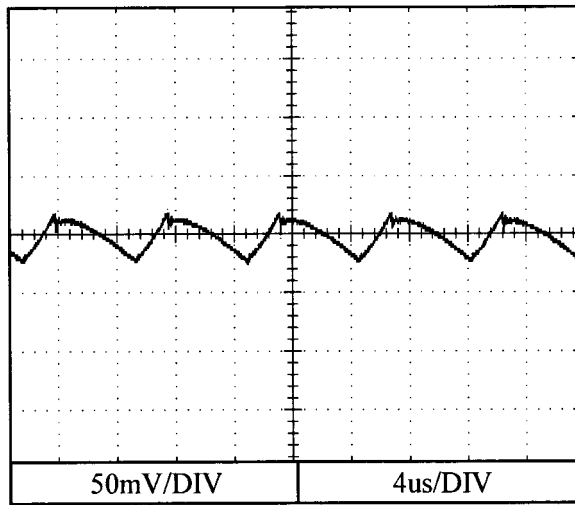

12V

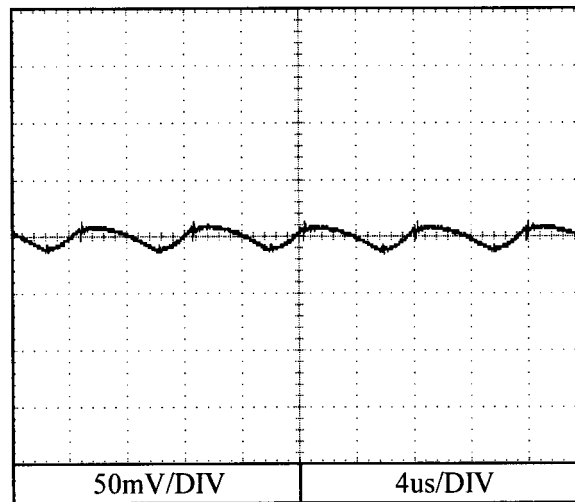

24V

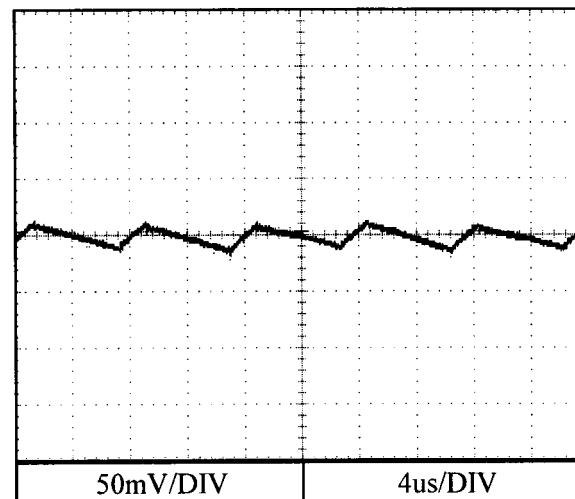

2.15 Output ripple and noise waveform

Conditions: V_{in} : 230VAC
 I_{out} : 100%
 T_a : 25°C

NORMAL MODE

5V

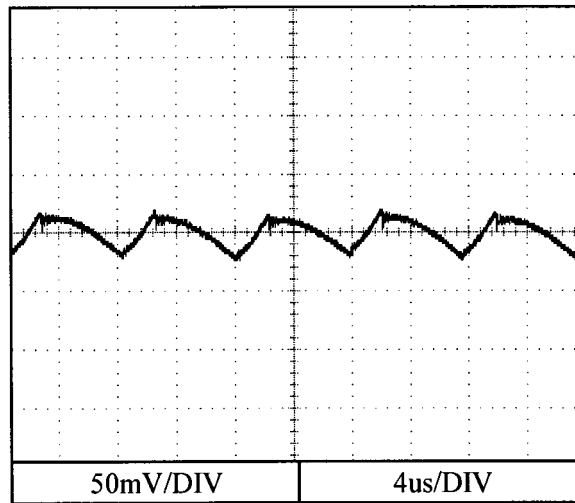

12V

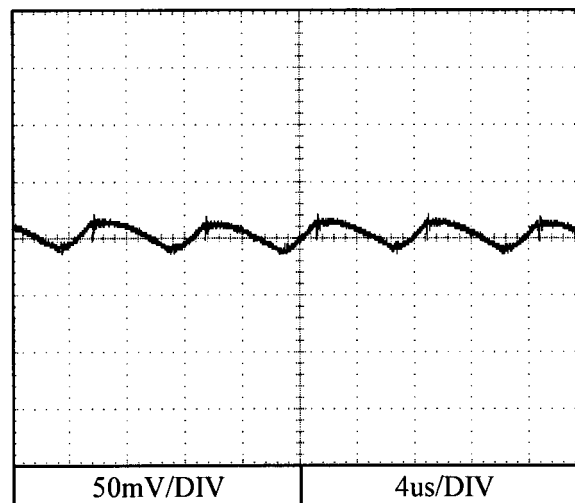

24V

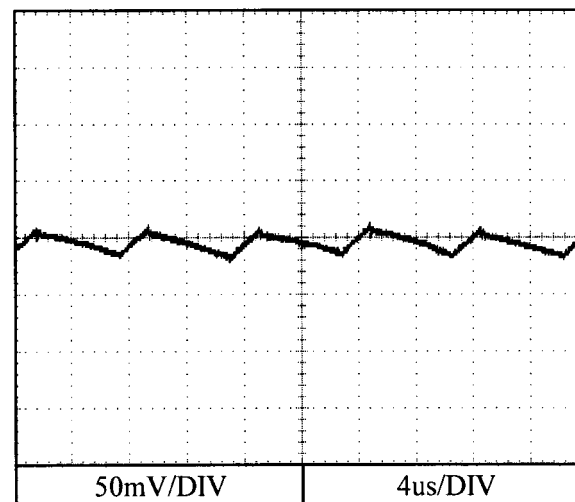

2.15 Output ripple and noise waveform

Conditions: V_{in} : 115VAC
 I_{out} : 100%
 T_a : 25°C

NORMAL+COMMON MODE

5V

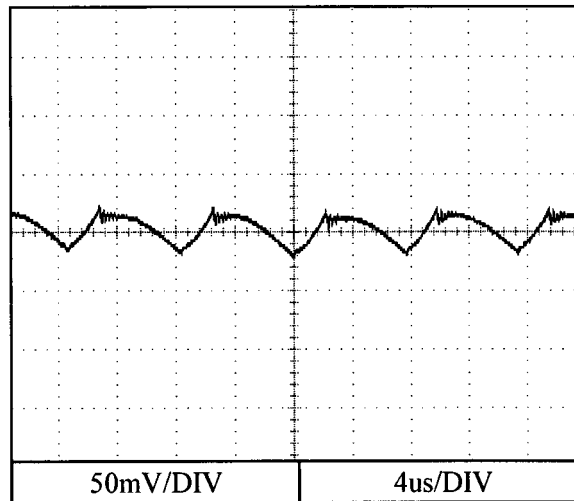

12V

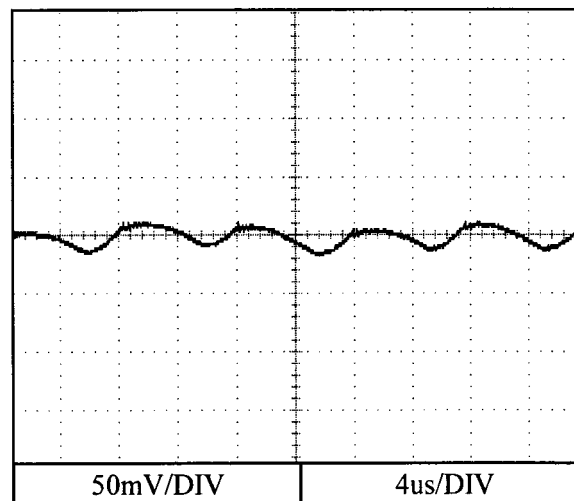

24V

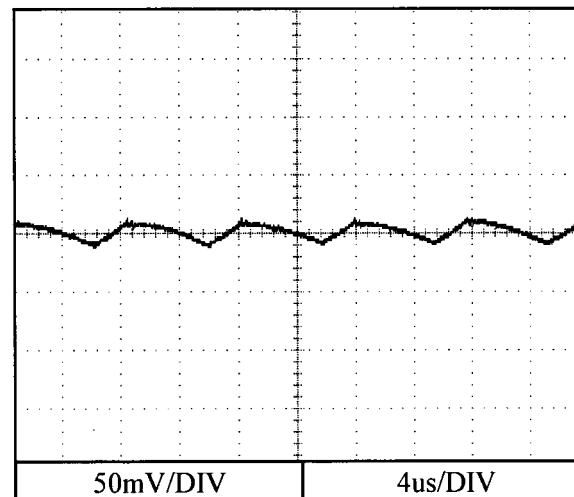

2.15 Output ripple and noise waveform

Conditions: V_{in} : 230VAC
 I_{out} : 100%
 T_a : 25°C

NORMAL+COMMON MODE

5V

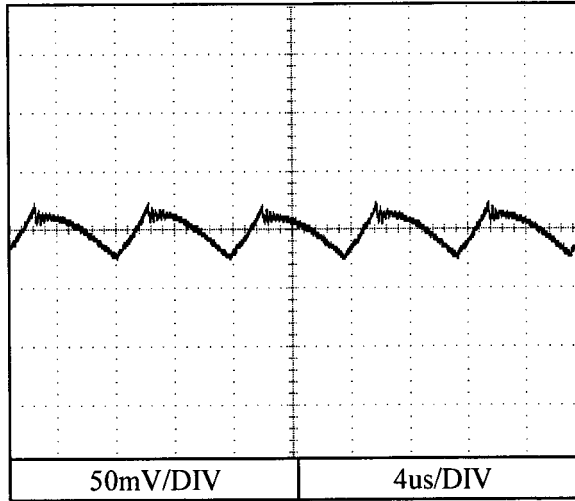

12V

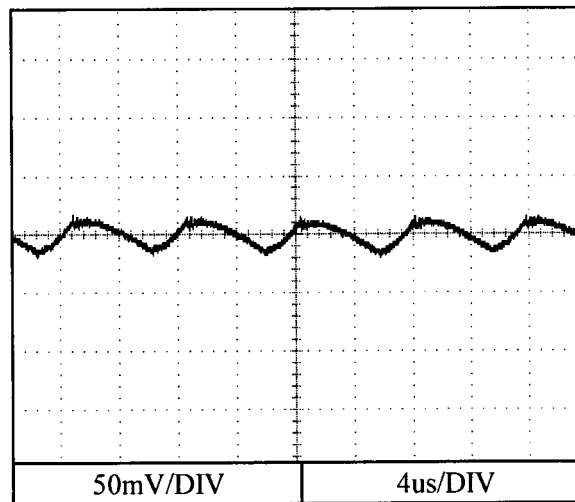

24V

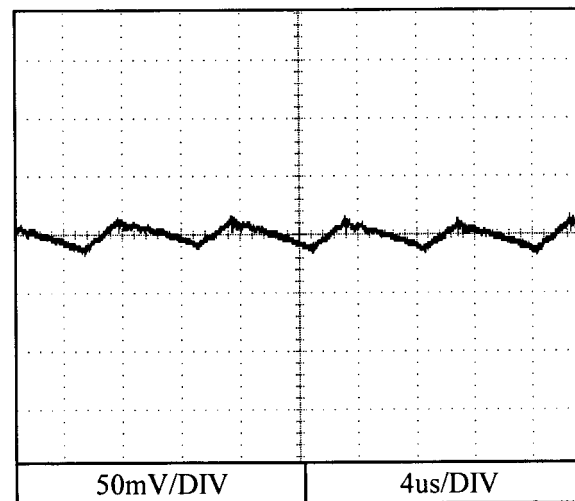

2.16 Electro-Magnetic Interference characteristics

Conditions: Vin : 115VAC
Iout : 100%

Conducted Emission

5V

Point A (0.18MHz)		
Ref.	Limit (dB μ V)	Measure (dB μ V)
QP	64.5	47.2
AV	54.5	45.2

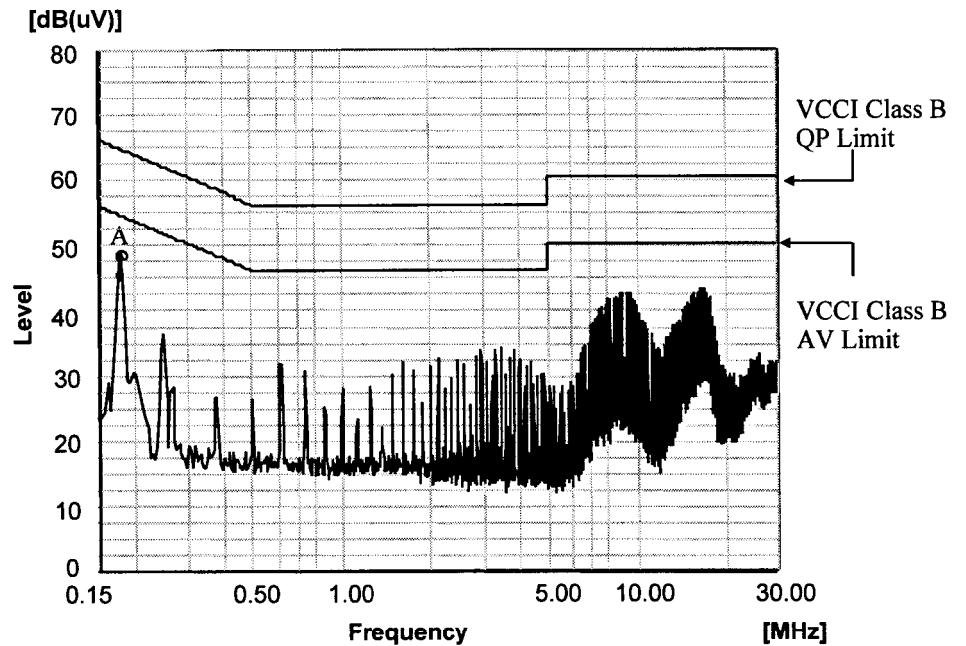

Phase : L

Point B (0.18MHz)		
Ref.	Limit (dB μ V)	Measure (dB μ V)
QP	64.5	48.8
AV	54.5	45.2

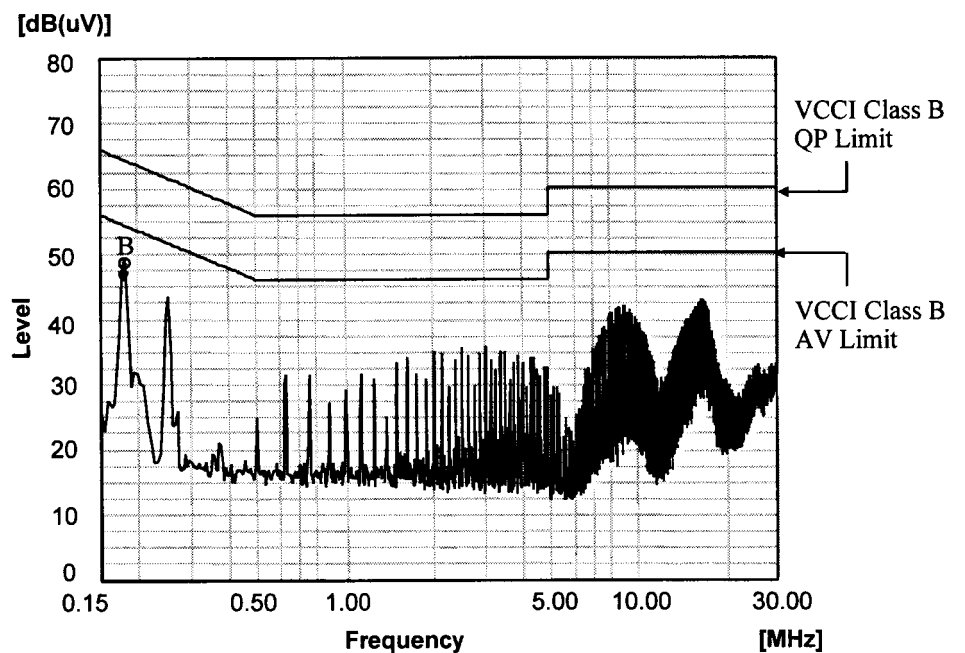

Phase : N

Limit of EN55011-B,EN55022-B are same as its VCCI Class B.

2.16 Electro-Magnetic Interference characteristics

Conditions: Vin : 230VAC
Iout : 100%

Conducted Emission

5V

Ref.	Point A (0.18MHz)	
	Limit (dB μ V)	Measure (dB μ V)
QP	64.5	49.9
AV	54.5	47.2

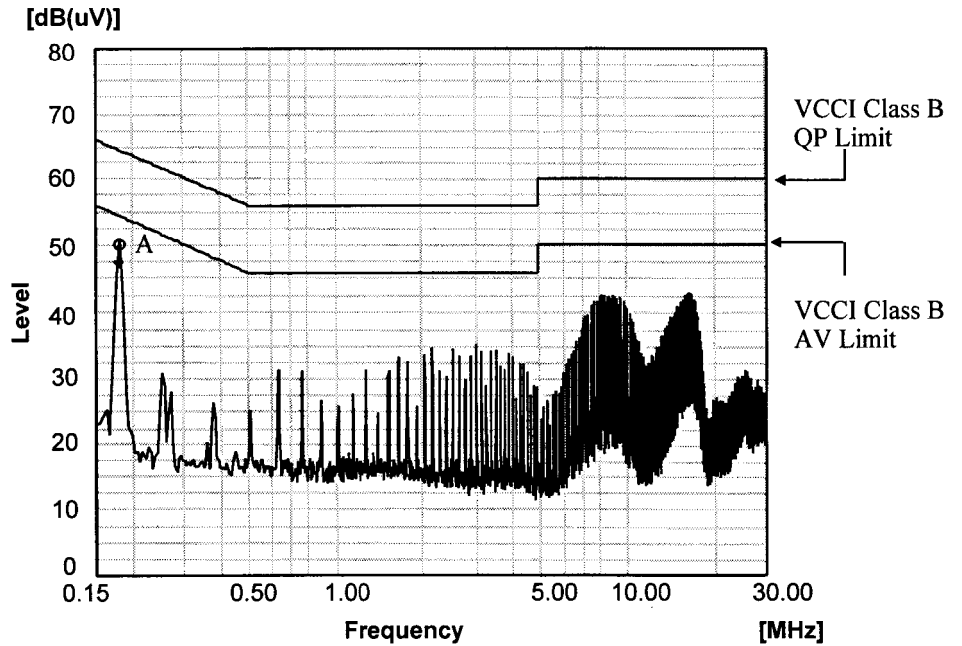

Phase : L

Ref.	Point B (0.18MHz)	
	Limit (dB μ V)	Measure (dB μ V)
QP	64.5	49.2
AV	54.5	46.5

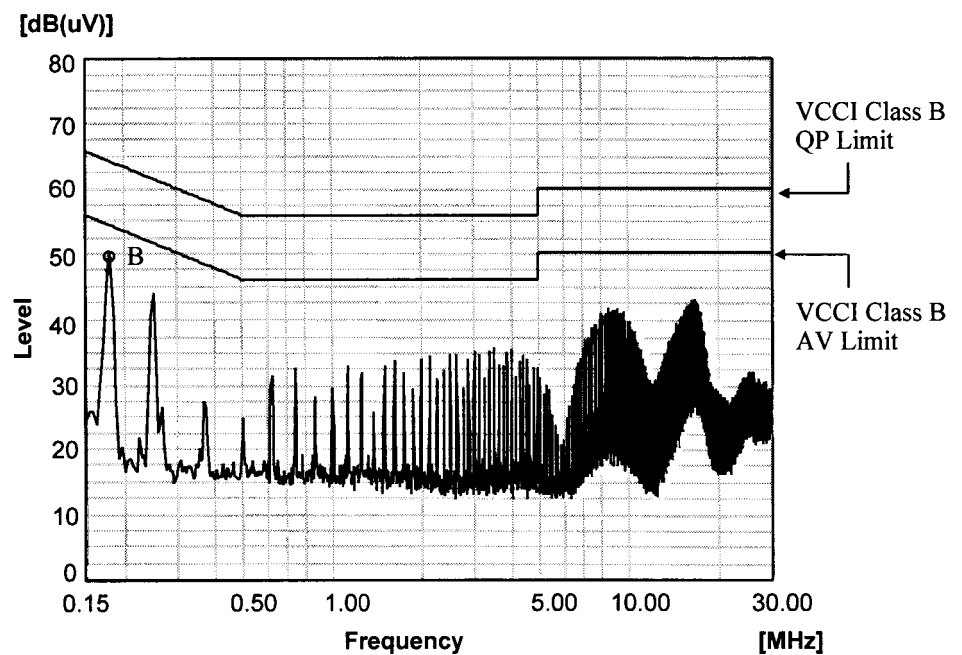

Phase : N

Limit of EN55011-B,EN55022-B are same as its VCCI Class B.

2.16 Electro-Magnetic Interference characteristics

Conditions: Vin : 115VAC
Iout : 100%

Conducted Emission

12V

Ref.	Point A (0.18MHz)	
	Limit (dBμV)	Measure (dBμV)
QP	64.5	49.9
AV	54.5	47.5

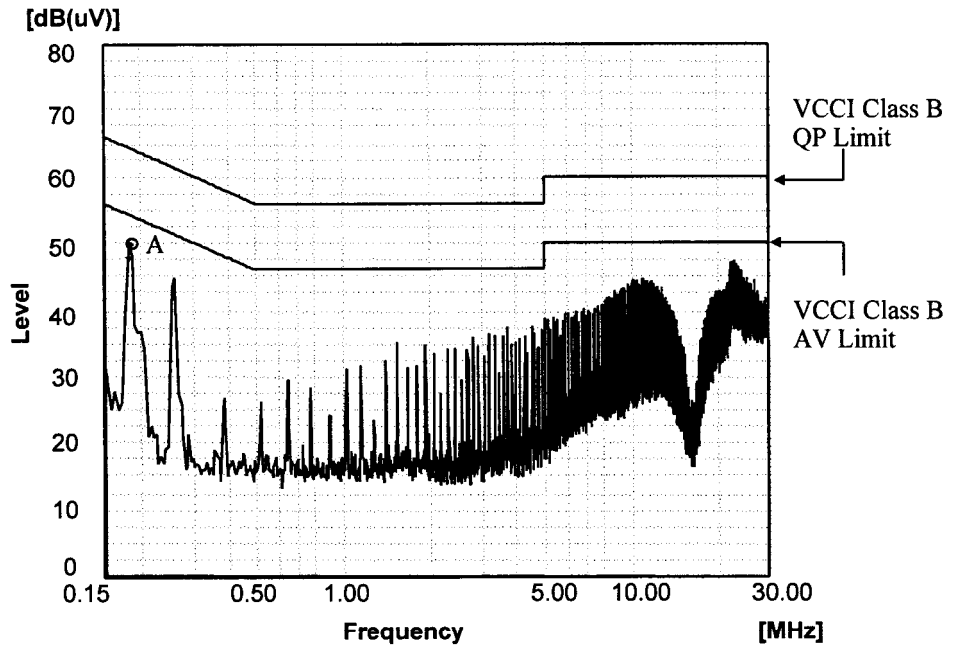

Phase : L

Ref.	Point B (0.18MHz)	
	Limit (dBμV)	Measure (dBμV)
QP	64.5	51.2
AV	54.5	47.7

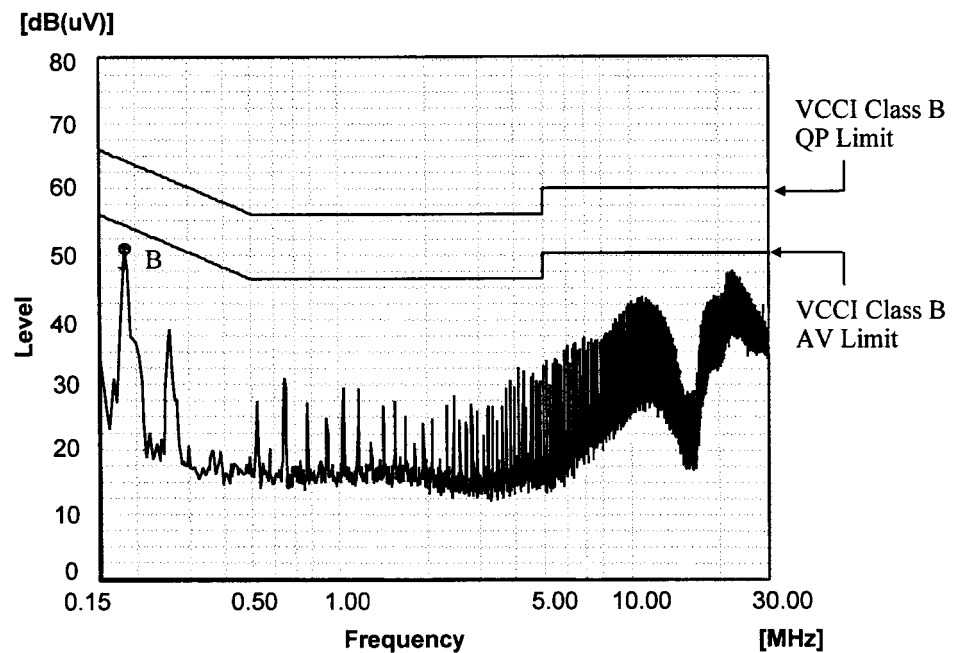

Phase : N

Limit of EN55011-B,EN55022-B are same as its VCCI Class B.

2.16 Electro-Magnetic Interference characteristics

Conditions: Vin : 230VAC
Iout : 100%

Conducted Emission

12V

Ref.	Point A (0.18MHz)	
	Limit (dB μ V)	Measure (dB μ V)
QP	64.5	50.1
AV	54.5	48.1

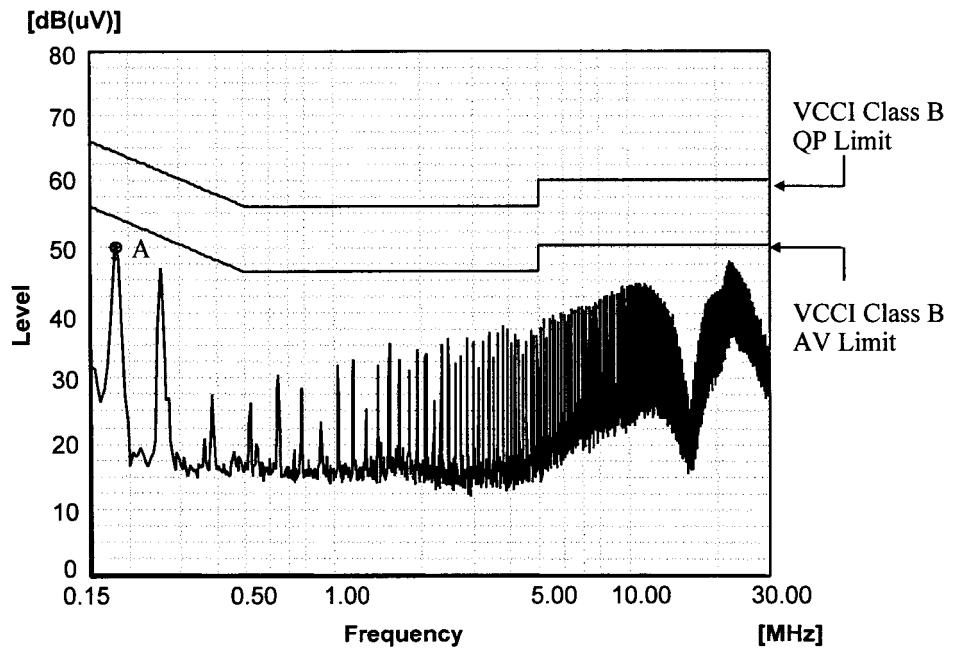

Phase : L

Ref.	Point B (0.18MHz)	
	Limit (dB μ V)	Measure (dB μ V)
QP	64.5	50.6
AV	54.5	48.2

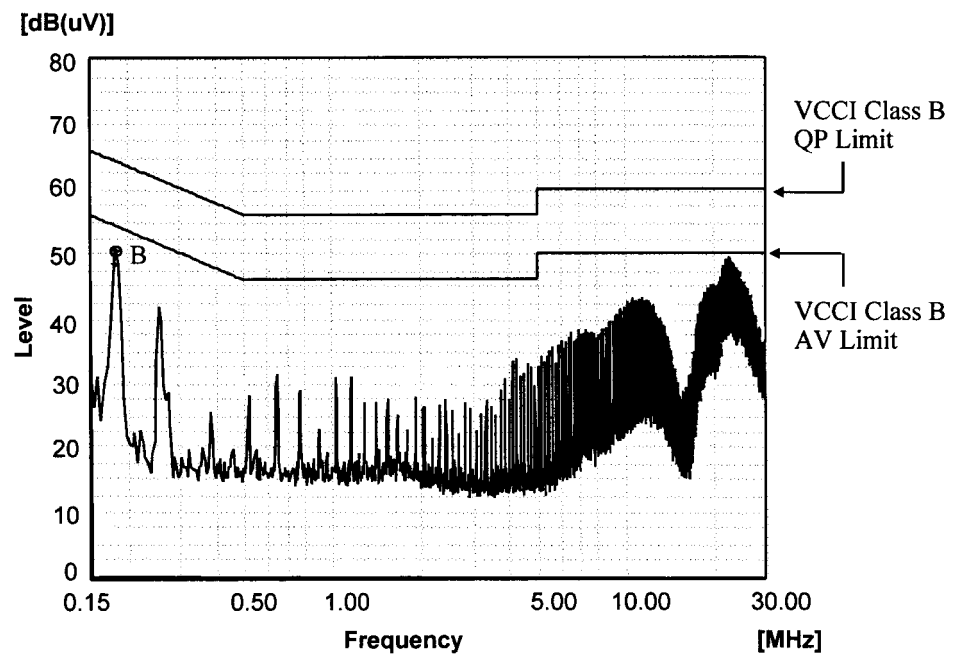

Phase : N

Limit of EN55011-B,EN55022-B are same as its VCCI Class B.

2.16 Electro-Magnetic Interference characteristics

Conditions: Vin : 115VAC
Iout : 100%

Conducted Emission

24V

Ref.	Point A (0.18MHz)	
	Limit (dB μ V)	Measure (dB μ V)
QP	64.5	49.1
AV	54.5	47.1

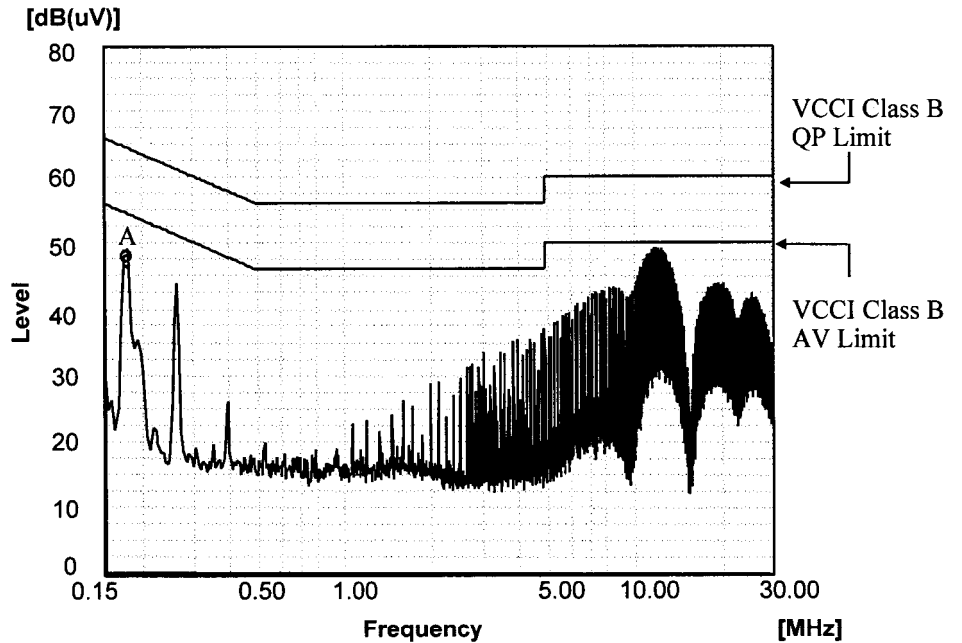

Phase : L

Ref.	Point B (0.18MHz)	
	Limit (dB μ V)	Measure (dB μ V)
QP	64.5	49.5
AV	54.5	47.1

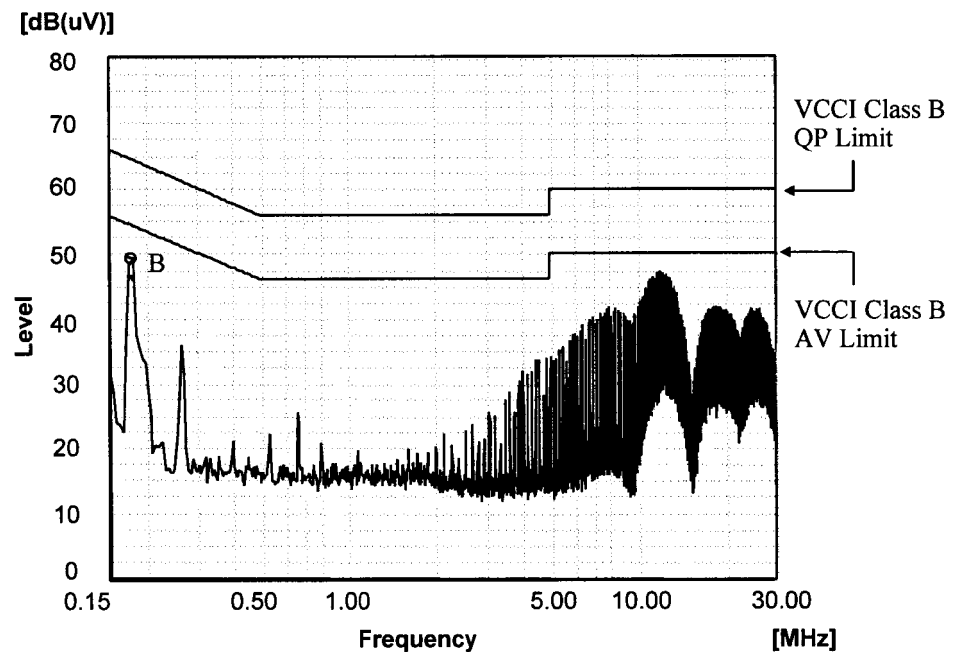

Phase : N

Limit of EN55011-B, EN55022-B are same as its VCCI Class B.

2.16 Electro-Magnetic Interference characteristics

Conditions: Vin : 230VAC
Iout : 100%

Conducted Emission

24V

Ref.	Point A (0.18MHz)	
	Limit (dB μ V)	Measure (dB μ V)
QP	64.5	49.1
AV	54.5	47.1

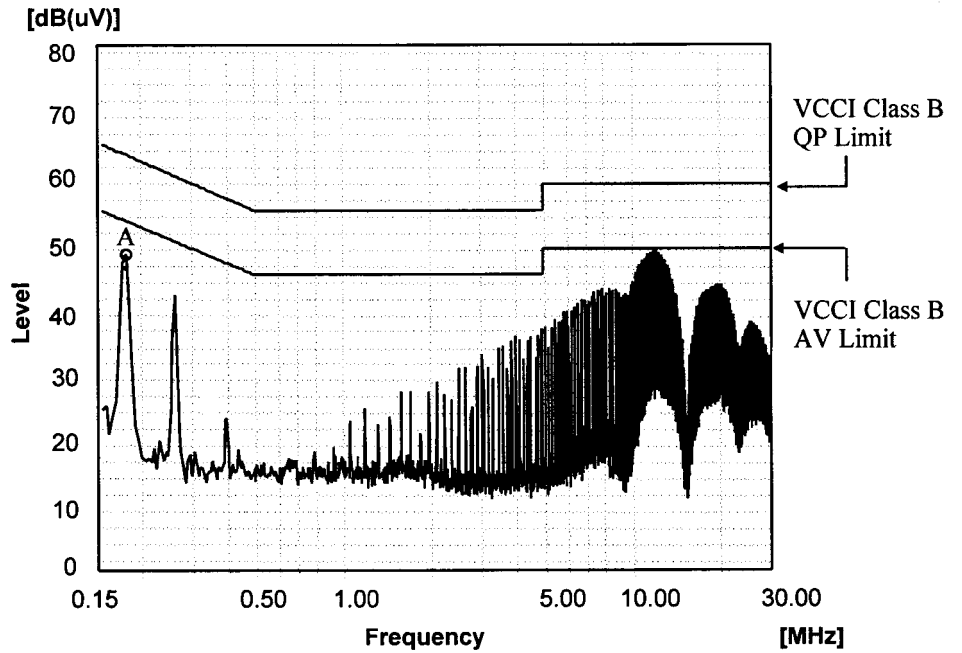

Phase : L

Ref.	Point B (0.18MHz)	
	Limit (dB μ V)	Measure (dB μ V)
QP	64.5	49.5
AV	54.5	47.1

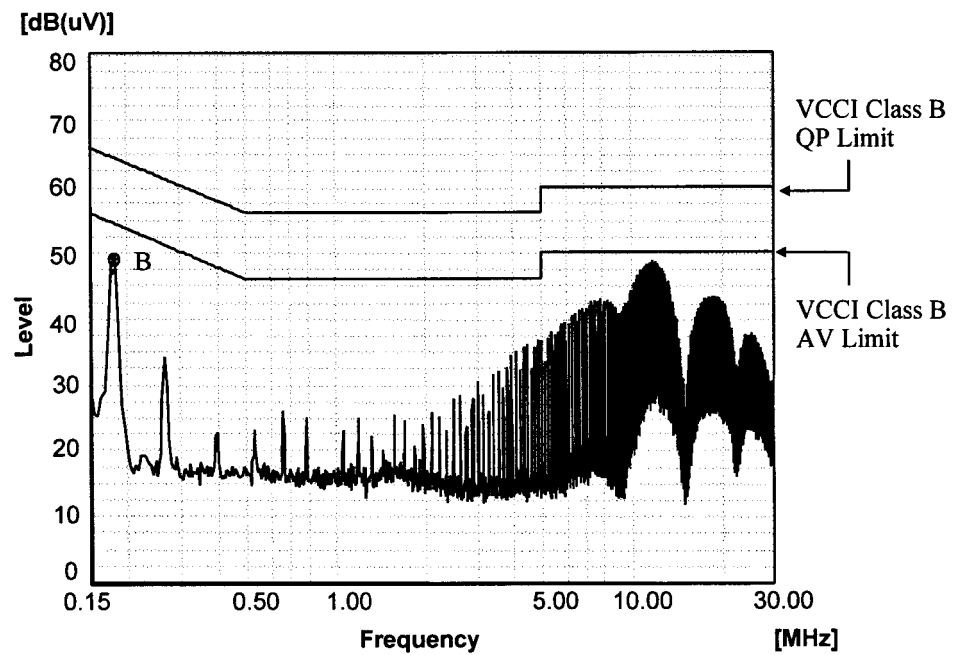

Phase : N

Limit of EN55011-B,EN55022-B are same as its VCCI Class B.

2.16 Electro-Magnetic Interference characteristics

Conditions: Vin : 115VAC
Iout : 100%

Radiated Emission

5V

HORIZONTAL

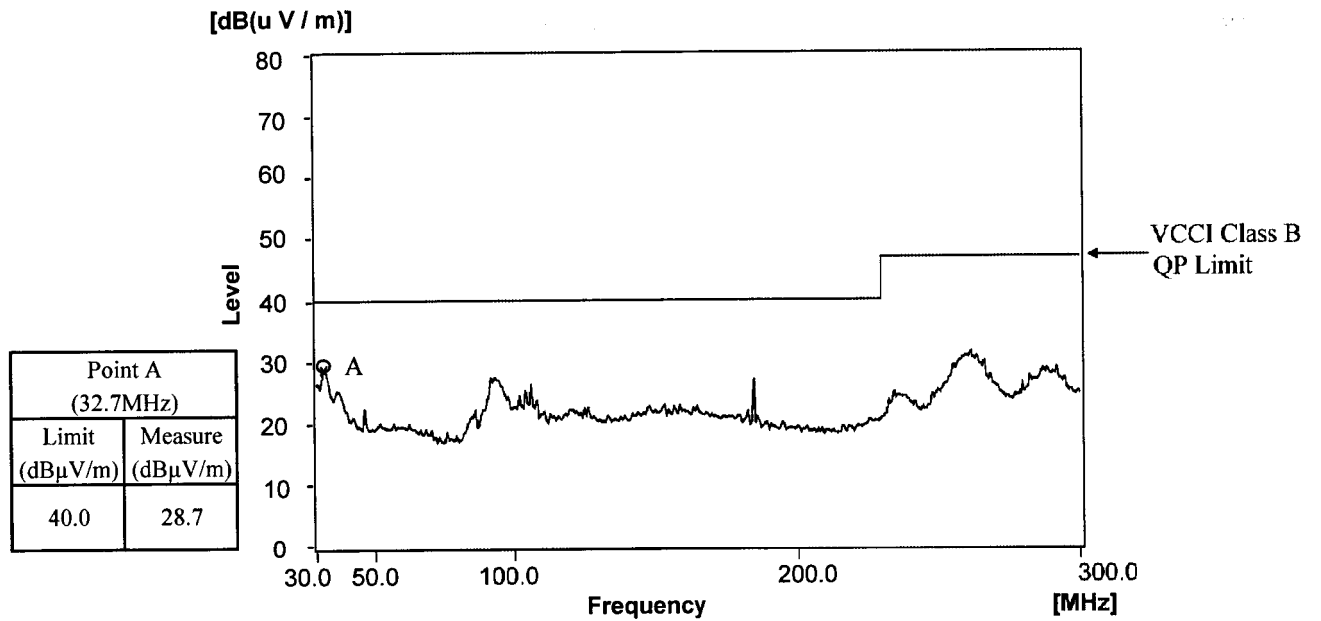

VERTICAL

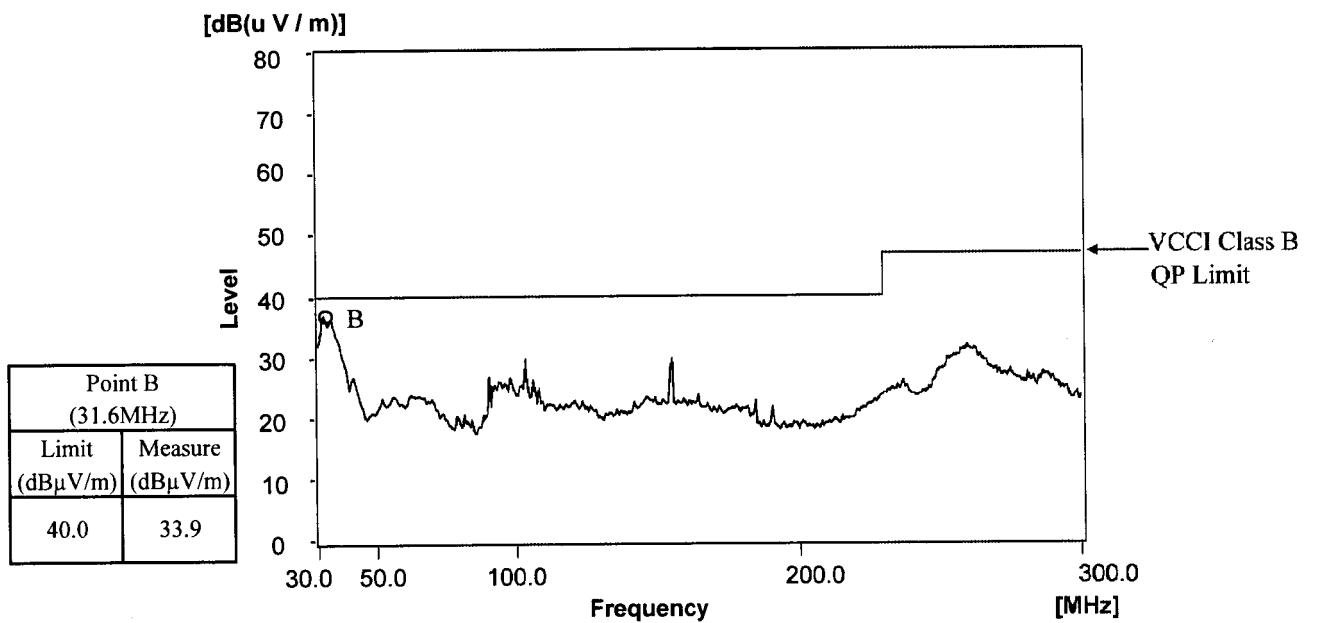

Limit of EN55011-B, EN55022-B are same as its VCCI Class B.

2.16 Electro-Magnetic Interference characteristics

Conditions: Vin : 230VAC
Iout : 100%

Radiated Emission

5V

HORIZONTAL

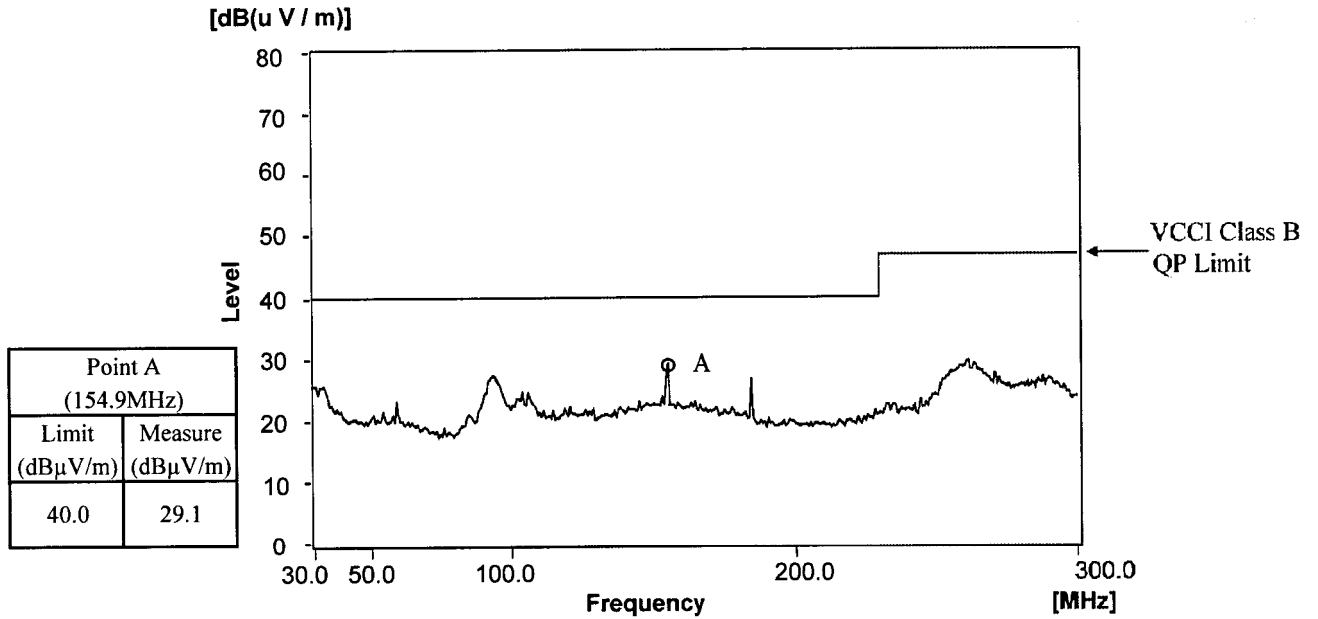

VERTICAL

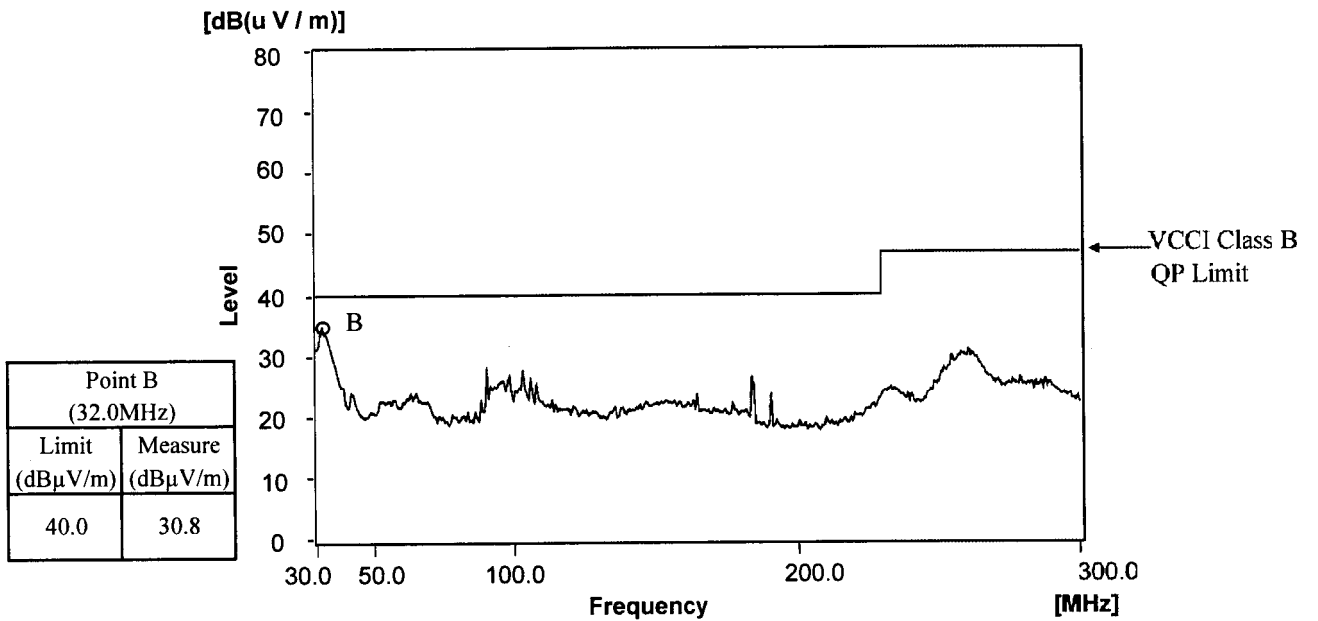

Limit of EN55011-B, EN55022-B are same as its VCCI Class B.

2.16 Electro-Magnetic Interference characteristics

Conditions: V_{in} : 115VAC
 I_{out} : 100%

Radiated Emission

12V

HORIZONTAL

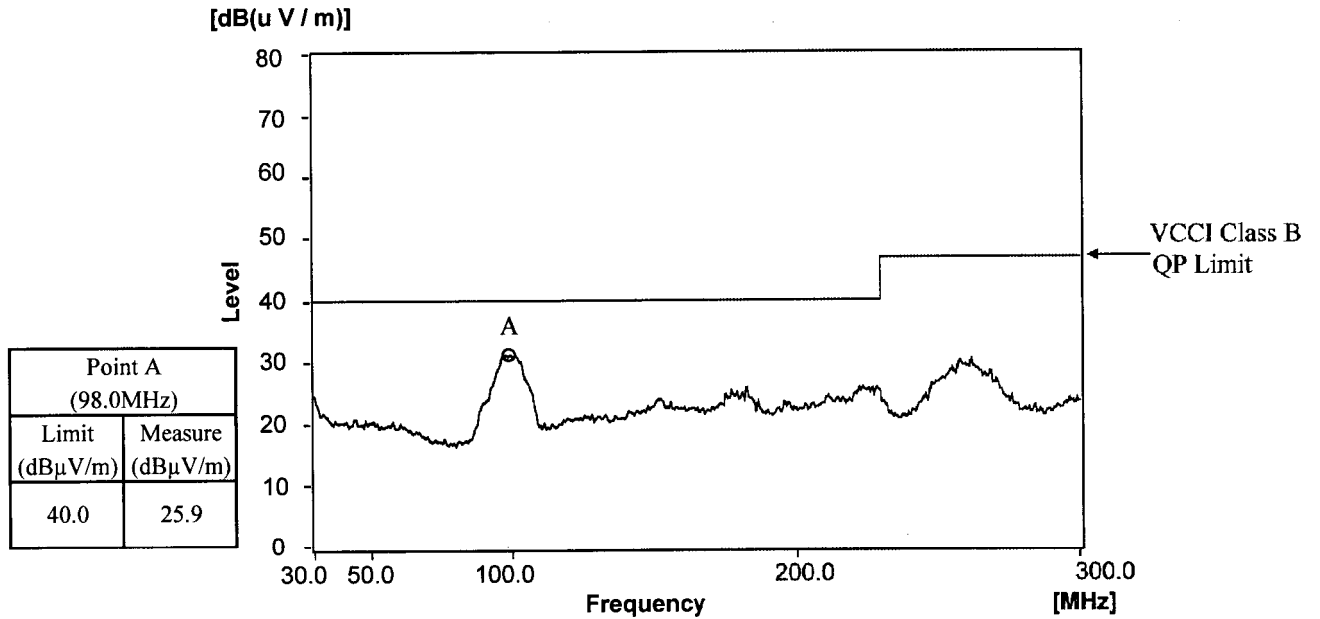

VERTICAL

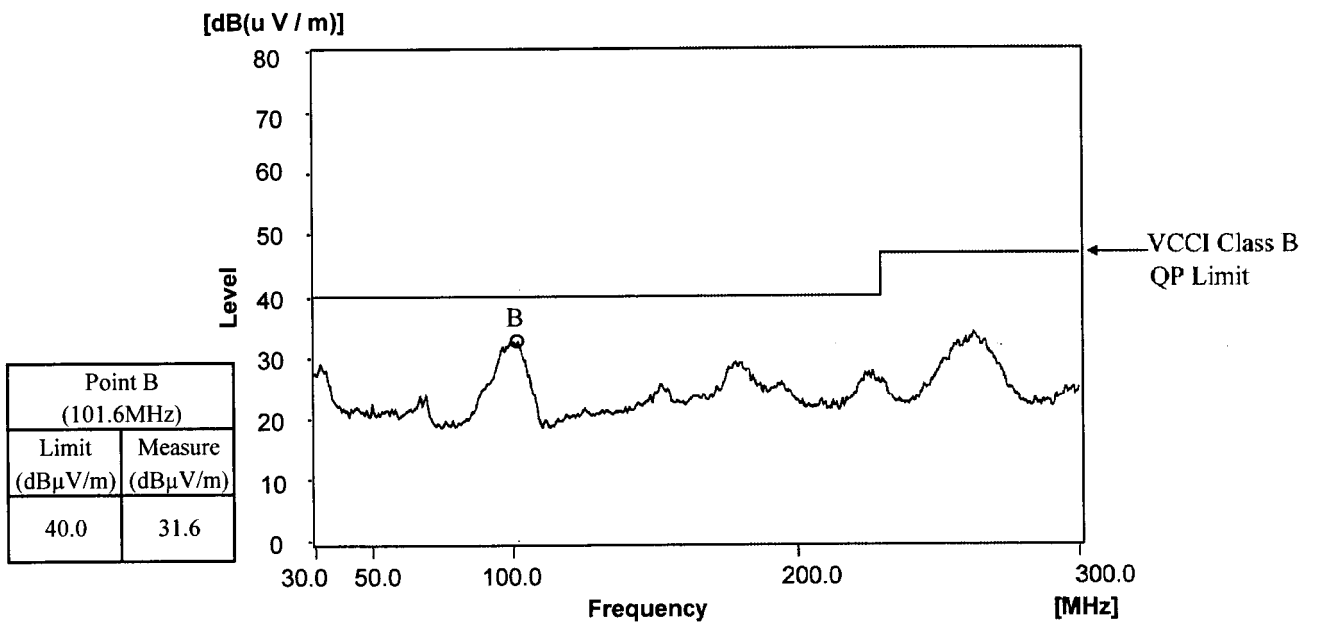

Limit of EN55011-B,EN55022-B are same as its VCCI Class B.

2.16 Electro-Magnetic Interference characteristics

Conditions: Vin : 230VAC
Iout : 100%

Radiated Emission

12V

HORIZONTAL

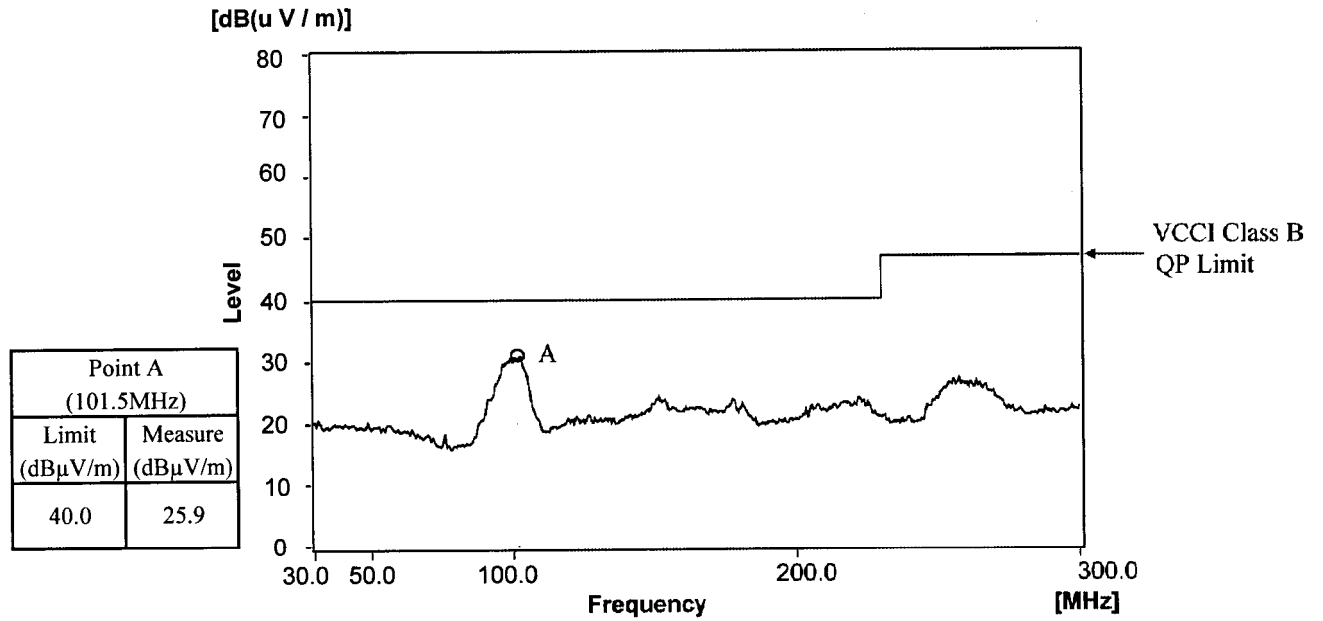

VERTICAL

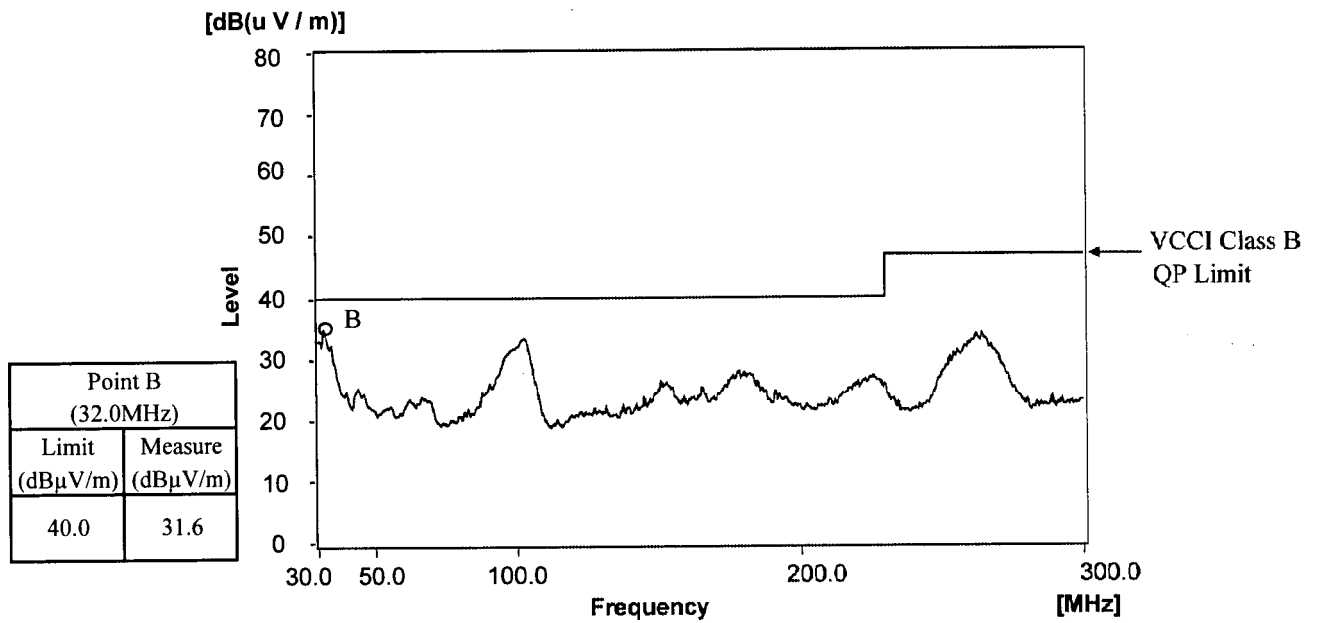

Limit of EN55011-B,EN55022-B are same as its VCCI Class B.

2.16 Electro-Magnetic Interference characteristics

Conditions: Vin : 115VAC
Iout : 100%

Radiated Emission

24V

HORIZONTAL

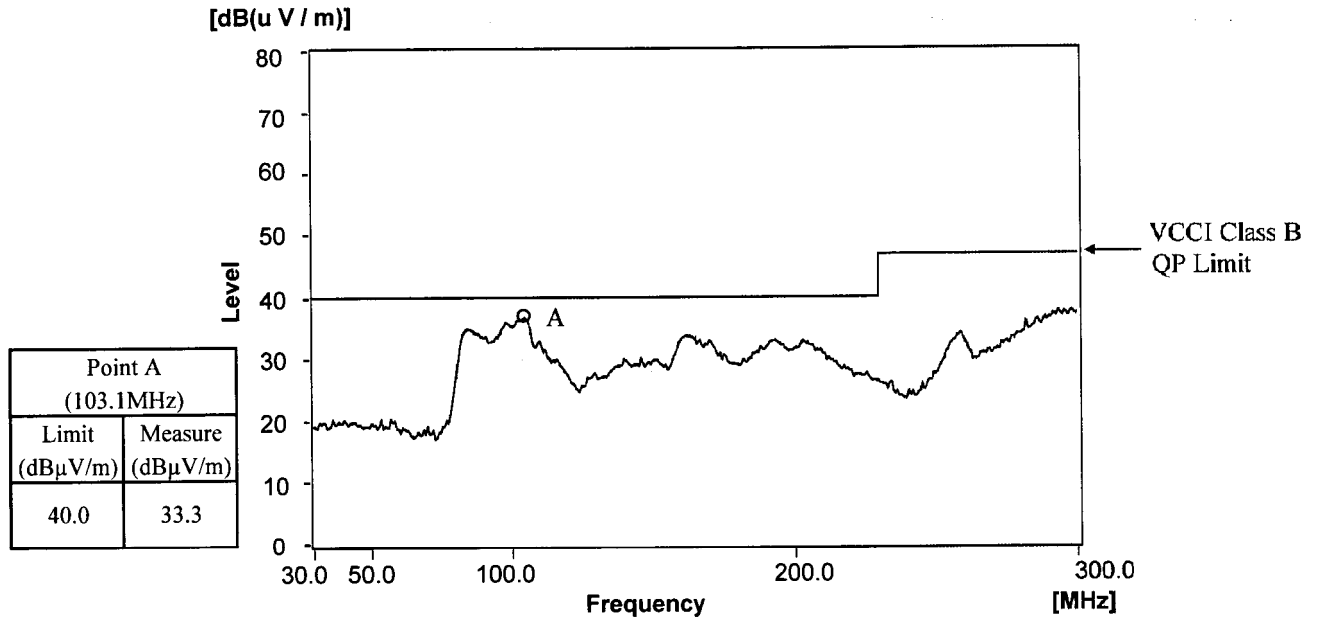

VERTICAL

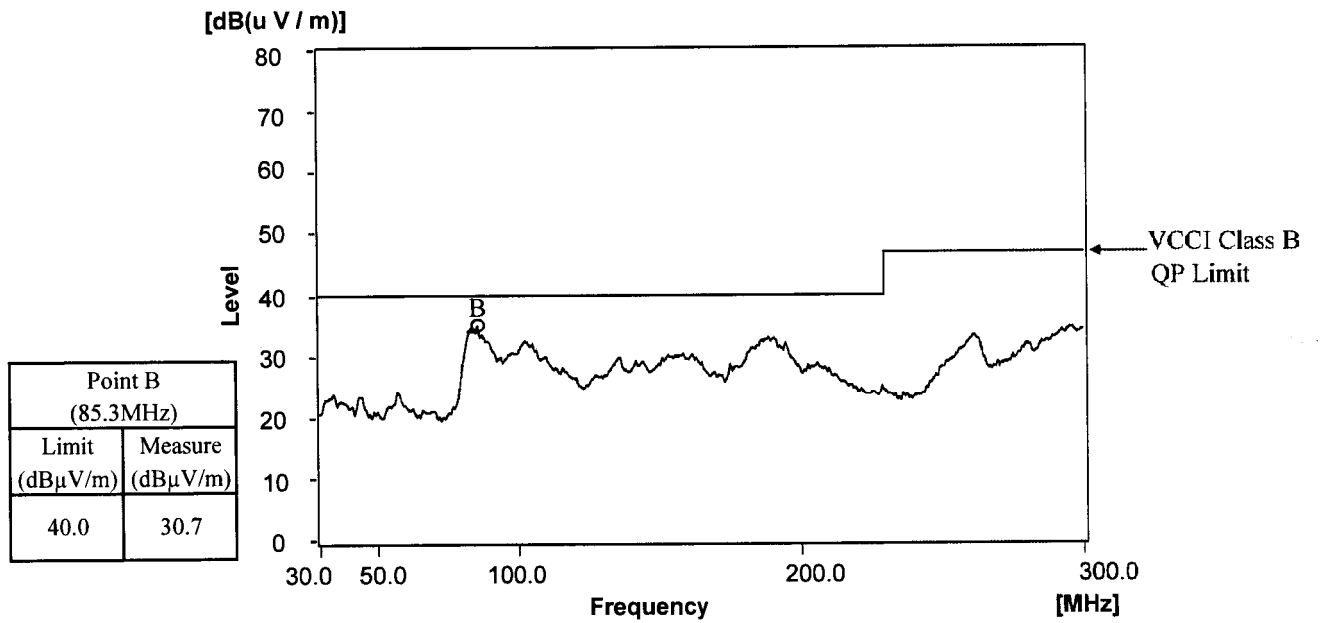

Limit of EN55011-B,EN55022-B are same as its VCCI Class B.

2.16 Electro-Magnetic Interference characteristics

Conditions: Vin : 230VAC
Iout : 100%

Radiated Emission

24V

HORIZONTAL

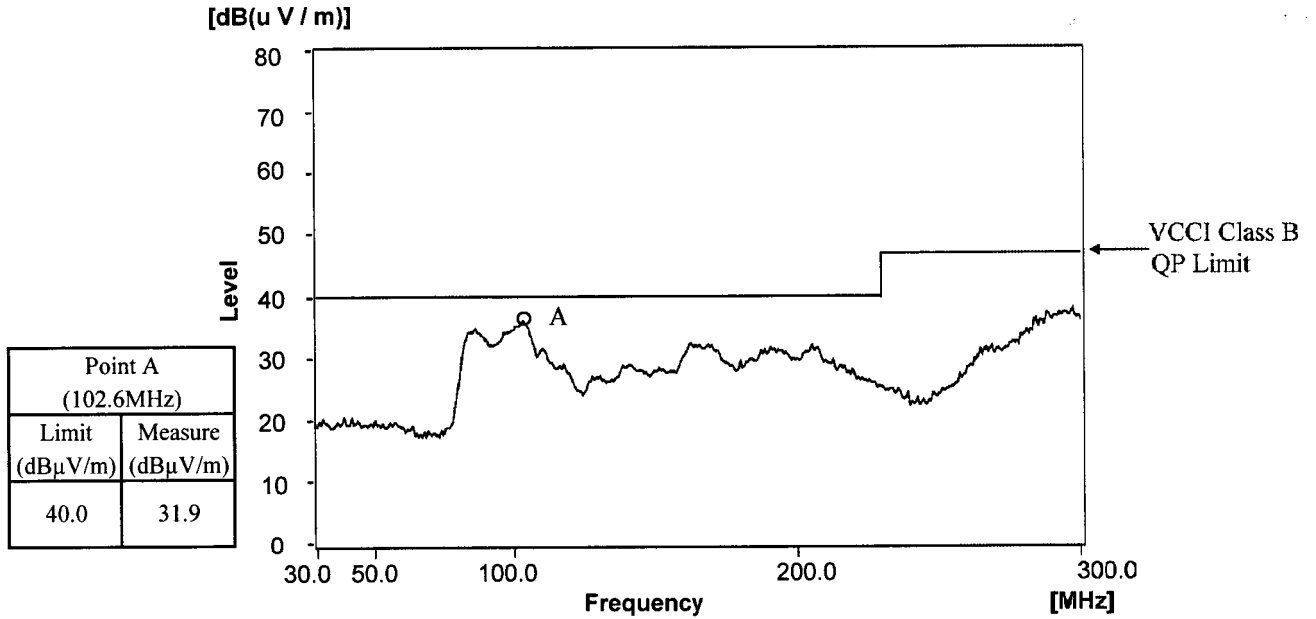

VERTICAL

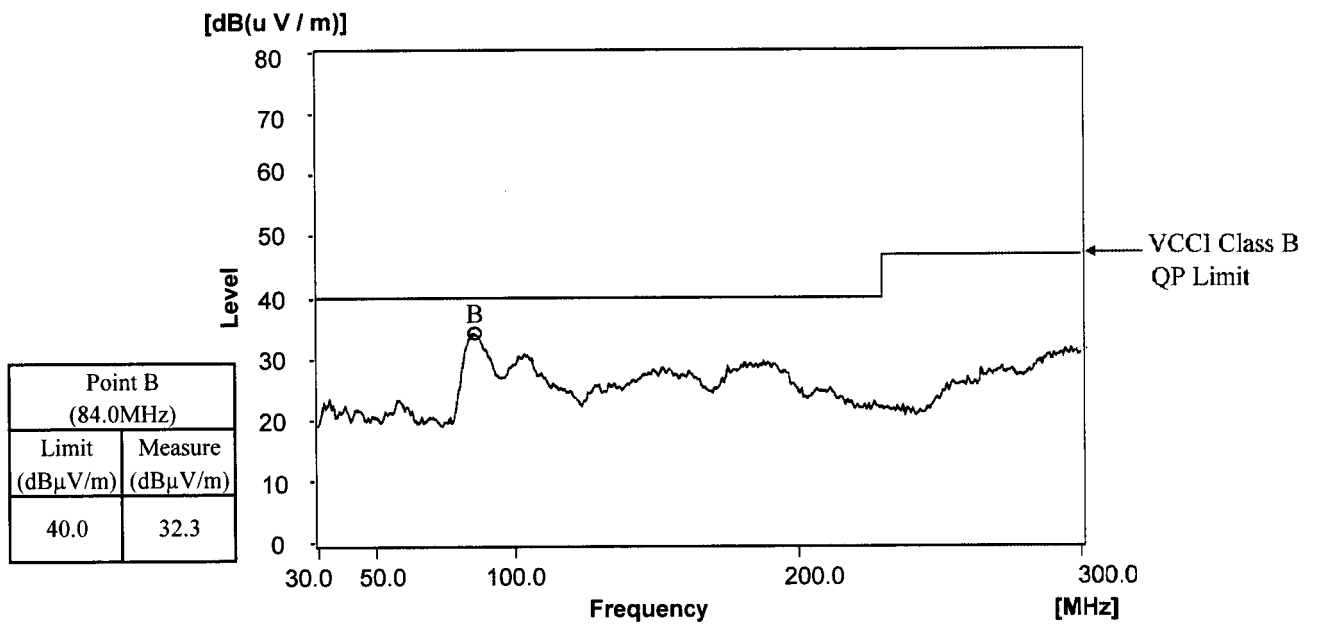

Limit of EN55011-B,EN55022-B are same as its VCCI Class B.