



Test Report issued under the responsibility of:



TEST REPORT
IEC 62368-1
Audio/video, information and communication technology equipment
Part 1: Safety requirements

Report Number: E135494-A6039-CB-1
Date of issue.....: 2020-04-17
Total number of pages: 181

Applicant's name.....: **TDK-LAMBDA UK LTD**
Address: **KINGSLEY AVE**
ILFRACOMBE
EX34 8ES UNITED KINGDOM

Name of Test Laboratory: UL VS Limited
preparing the Report: Unit 1-3 Horizon, Wade Road, Kingsland Business Park, Basingstoke
 RG24 8AH, United Kingdom





Test specification:
Standard: IEC 62368-1:2014 (Second Edition)
Test procedure: CB Scheme
Non-standard test method.....: N/A

Test Report Form No.....: IEC62368_1B
Test Report Form(s) Originator: UL(US)
Master TRF.....: 2014-03

Copyright © 2014 Worldwide System for Conformity Testing and Certification of Electrotechnical Equipment and Components (IECEE), Geneva, Switzerland. All rights reserved.
 This publication may be reproduced in whole or in part for non-commercial purposes as long as the IECEE is acknowledged as copyright owner and source of the material. IECEE takes no responsibility for and will not assume liability for damages resulting from the reader's interpretation of the reproduced material due to its placement and context.
 If this Test Report Form is used by non-IECEE members, the IECEE/IEC logo and the reference to the CB Scheme procedure shall be removed.
This report is not valid as a CB Test Report unless signed by an approved CB Testing Laboratory and appended to a CB Test Certificate issued by an NCB in accordance with IECEE 02.

General disclaimer:
 The test results presented in this report relate only to the object tested.
 This report shall not be reproduced, except in full, without the written approval of the Issuing CB Testing Laboratory.
 The authenticity of this Test Report and its contents can be verified by contacting the NCB, responsible for this Test Report.

Test Item description	:	AC-DC Switch Mode Power Supply
Trade Mark	:	TDK-Lambda 
Manufacturer	:	TDK-LAMBDA UK LTD KINGSLEY AVE ILFRACOMBE EX34 8ES UNITED KINGDOM
Model/Type reference	:	NV700 or NV-700 Range, RA-PFC-001 (see Model Differences for details of NV700 Range model configurations)
Ratings	:	NV700 or NV-700 Range: 100-240Vac nominal (90-264V max. tolerance), 47-440Hz, 11A max (see Model Differences for details of model ratings) RA-PFC-001: Input: 100-240Vac nominal (90-264V max. tolerance), 47-63Hz, 11A max. Output: 350Vdc, 2.3A max
Testing procedure and testing location:		
<input type="checkbox"/>	CB Testing Laboratory:	
Testing location/ address		
Tested by (name + signature)		
Approved by (name + signature)		
Testing procedure: CTF Stage 1		
Testing location/ address		
Tested by (name + signature)		
Approved by (name + signature)		
Testing procedure: CTF Stage 2		
Testing location/ address		
Tested by (name + signature)		
Witnessed by (name + signature)		
Approved by (name + signature)		
<input checked="" type="checkbox"/>	Testing procedure: CTF Stage 3	

<input type="checkbox"/>	Testing procedure: CTF Stage 4	
Testing location/ address..... :	TDK-LAMBDA UK LTD KINGSLEY AVE ILFRACOMBE EX34 8ES UNITED KINGDOM	
Tested by (name + signature)..... :	Mr T Wordley, Mr M Carter / Safety Engineer	
Witnessed by (name + signature)..... :	Mark John De Sagun / Project Handler	
Approved by (name + signature) :	Dennis Butcher / Reviewer	
Supervised by (name + signature) :	Dennis Butcher / Reviewer	

List of Attachments (including a total number of pages in each attachment):

National Differences (30 pages)

Enclosures (82 pages)

Summary of testing:

Tests performed (name of test and test clause):

STEADY FORCE TEST, 250 N (4.4.4.2, ANNEX T.5)
 STEADY FORCE TEST, 30 N (4.4.4.2, ANNEX T.3)
 IMPACT TEST (4.4.4.4, ANNEX T.6)
 CLASSIFICATION OF ELECTRICAL ENERGY SOURCES (5.2, 5.7)
 SEPARABLE THIN SHEET MATERIAL (5.4.4.6.2)
 ELECTRIC STRENGTH TEST (5.4.9)
 SAFEGUARDS AGAINST CAPACITOR DISCHARGE AFTER DISCONNECTION OF A CONNECTOR (5.5.2.2)
 RESISTANCE OF THE PROTECTIVE BONDING SYSTEM (5.6.6.2)
 PROSPECTIVE TOUCH VOLTAGE AND TOUCH CURRENT MEASUREMENT (5.7)
 INPUT TEST: SINGLE PHASE (B.2.5)
 NORMAL OPERATING CONDITIONS TEMPERATURE MEASUREMENT (B.2.6)
 SIMULATED ABNORMAL OPERATING CONDITIONS (B.3)
 SIMULATED SINGLE FAULT CONDITIONS (B.4)
 TRANSFORMER OVERLOAD (ANNEX G.5.3.3)

Testing Location:

**CTF Stage 3: TDK-LAMBDA UK LTD
 KINGSLEY AVE
 ILFRACOMBE
 EX34 8ES UNITED KINGDOM**

Additional tests conducted as confirmation testing for 62368 approval.
 See enclosure 7-02 for waiver of tests taken from 60950-1 report E135494-A53.
 Additional tests conducted as confirmation testing for 62368 approval.
 See enclosure 7-02 for waiver of tests taken from 60950-1 report E135494-A53.
 Additional tests conducted as confirmation testing for 62368 approval.
 See enclosure 7-02 for waiver of tests taken from 60950-1 report E135494-A53.
 Additional tests conducted as confirmation testing for 62368 approval.
 See enclosure 7-02 for waiver of tests taken from 60950-1 report E135494-A53.
 Additional tests conducted as confirmation testing for 62368 approval.
 See enclosure 7-02 for waiver of tests taken from 60950-1 report E135494-A53.

ALTERNATIVE RUNNING OVERLOAD TEST
FOR D.C. MOTORS (ANNEX G.5.4.5.3)

LIMITED SHORT CIRCUIT TEST (ANNEX R.1,
5.6.4.1, 5.6.4.4, 5.6.5.1)

STEADY FORCE TEST, 10 N (ANNEX T.2 ,
5.4.2.6, 5.4.3.2, G.15.3.6)

Summary of compliance with National Differences:

List of countries addressed: Australia / New Zealand, EU Group and National Differences, Japan, USA / Canada

EU Group and National Differences applies to CENELEC member countries: Austria , Belgium, Bulgaria, Croatia, Cyprus, the Czech Republic, Denmark, Estonia, Finland, France, Germany, Greece, Hungary, Iceland, Ireland, Italy, Latvia, Lithuania, Luxembourg, Malta, the Netherlands, Norway, Poland, Portugal, Republic of North Macedonia, Romania, Serbia, Slovakia, Slovenia, Spain, Sweden, Switzerland, Turkey and the United Kingdom

The product fulfils the requirements of: EN 62368-1:2014 + A11:2017, CSA CAN/CSA-C22.2 No. 62368-1 2nd Edition, Issued December 1, 2014

Copy of Marking Plate - Refer to Enclosure titled Marking Plate for copy.

TEST ITEM PARTICULARS:	
Classification of use by	Skilled person, Ordinary person
Supply Connection	AC Mains
Supply % Tolerance	+10%/-10%
Supply Connection – Type	pluggable equipment type A - appliance coupler mating connector
Considered current rating of protective device as part of building or equipment installation	20 A; building;
Equipment mobility	for building-in
Over voltage category (OVC)	OVC II
Class of equipment	Class I
Access location	N/A
Pollution degree (PD)	PD 2
Manufacturer’s specified maximum operating ambient (°C)	45°C (full load at 90-99.9Vac), 50°C (full load at 100-264Vac), 65°C (Output power decreased linearly by 2.5%/°C above 50°C or above 45°C for 90-99.9V) (see model differences)
IP protection class	IPX0
Power Systems	TN
Altitude during operation (m)	5000 m
Altitude of test laboratory (m)	64 m
Mass of equipment (kg)	0.89 kg for basic unit without additional modules, (max 1.1kg fitted with additional modules and sub-assemblies)
POSSIBLE TEST CASE VERDICTS:	
- test case does not apply to the test object..... :	N/A
- test object does meet the requirement :	P (Pass)
- test object does not meet the requirement :	F (Fail)
TESTING:	
Date of receipt of test item..... :	2016-12-15 TO 2020-03-04
Date (s) of performance of tests..... :	2020-01-27 TO 2020-03-16
GENERAL REMARKS:	
<p>"(See Enclosure #)" refers to additional information appended to the report. "(See appended table)" refers to a table appended to the report.</p> <p>Throughout this report a <input type="checkbox"/> comma / <input checked="" type="checkbox"/> point is used as the decimal separator.</p>	
Manufacturer’s Declaration per sub-clause 4.2.5 of IEC62368-1:	

The application for obtaining a CB Test Certificate includes more than one factory location and a declaration from the Manufacturer stating that the sample(s) submitted for evaluation is (are) representative of the products from each factory has been provided :	<input checked="" type="checkbox"/> Yes <input type="checkbox"/> Not applicable
---	--

When differences exist; they shall be identified in the General product information section.

Name and address of factory (ies) :	TDK-LAMBDA UK LTD KINGSLEY AVE ILFRACOMBE EX34 8ES UNITED KINGDOM PANYU TRIO MICROTRONICS CO LTD SHIJI INDUSTRIAL ESTATE DONGYONG NANSHA GUANGZHOU GUANGDONG 511453 CHINA
--	--

GENERAL PRODUCT INFORMATION:

Report Summary

All applicable tests according to the referenced standard(s) have been carried out.

Product Description

NV700 or NV-700 series or power supplies for building into end equipment. (see Model Differences for details of model configurations) and RA-PFC-001 (the RA-PFC-001 is comprised of only a filter/boost assembly, chassis, cover, fan assembly, output assembly and output terminal block)

Model Differences

RA-PFC-001 consists of the main PFC Converter without any NV700 modules fitted.

NV700 models as described below:

Units may be marked with a Product Code: K7x or NV7x where x may be up to any six letters and/or numbers 0 to 9.

Unit Configuration (Description) Code:
 May be prefixed by NS # followed by / or - (where # may be any characters indicating non-safety related model differences).

May be prefixed by SP followed by / or – (SP represents a sales code)

Unit Configuration (Description) Code:

a) NV-700 or NV7 (these models are identical)

b) followed by: S or C
 where

S = Forward airflow, standard fan
C = Customer air, fan not fitted
U = Customer air, fan not fitted, cover not fitted

c) followed by: S or I

where

S = Screw input terminals

I = IEC input

d) followed by: S, M, L, R, or T

where

S = Standard Leakage (Class B Filter)

M = Medium Leakage

L = Low Leakage

R = Reduced Leakage

T = Tiny Leakage

Unit configuration may be given using the above code and/or by the option description. The input terminal type (screw or IEC) may alternatively be determined by examination of the unit.

e) optionally followed by: EN#V, EN*V, IN#V, IN*V, ES#V, ES*V, IS#V, IS*V.

where

EN#V = AC good, global module good, PSU enable, 5-5.5V, 2A standby output

EN*V = AC good, global module good, PSU enable, 12-13.5V, 1A standby output

IN#V = AC good, global module good, PSU inhibit, 5-5.5V, 2A standby output

IN*V = AC good, global module good, PSU inhibit, 12-13.5V, 1A standby output

ES#V = AC good, PSU enable, 5-5.5V, 2A standby output

ES*V = AC good, PSU enable, 12-13.5V, 1A standby output

IS#V = AC good, PSU inhibit, 5-5.5V, 2A standby output

IS*V = AC good, PSU inhibit, 12-13.5V, 1A standby output

where # represents the standby output voltage and is in the range 5 to 5.5V

where * represents the standby output voltage and is in the range 12-13.5V

The Global Options Inhibit and Enable functions permit the customer to turn off or on the main psu outputs and the fan. The standby supply is for use by the customer and provides an ES1 output that continues to operate when all the main psu outputs have been turned off using the Inhibit or Enable functions. All the functions of the Global Option pass through a single 8 way PWB socket and are all rated ES1.

Modules:

Up to 4 of the following modules types may be fitted:

@B

or @C

or @CM

or @BH

where @ is the output voltage of the module and is within the range given in the single output module table.

or @/#DB or @_#DB

where @ is the output voltage of channel 1 and # is the output voltage of channel 2 of the module. Voltages are within the range given in the DB module tables.

or @/#DA or @_#DA

where @ is the output voltage of channel 1 and # is the output voltage of channel 2 of the module. Voltages are within the range given in the DA module tables. Only 1 DA module may be fitted.

or B/S or B_S

where B/S indicates that a blanking plate is fitted in place of a module.

The following nomenclature may optionally be used for outputs connected in series:

(Note that outputs may be connected in series even when this nomenclature is not used)

@BB or @ BHB or @BBH or @BHBH or @CC or @CCM

where @ is the total voltage of any two B, BH, C or CM modules connected in series.

or @/#BDB or @_#BDB or @/#BHDB

where @ is the total series voltage of any B or BH module and DB module channel 1. # is the output voltage of the DB module channel 2. Voltages for # are within the range given in the DB module tables.

or @HDB

where @ is the total series voltage of any DB module channel 1 and channel 2.

For all outputs connected in series:

Permissible min. value for @ is given by summing the min. voltage ratings of the outputs connected in series.

Permissible max. value for @ is given by summing the max. voltage ratings of the outputs connected in series.

Custom Models:

Model: NV-700 RSS IN5V 12BH 12BH

Maximum outputs: 12.5V, 20A; 12.5V, 20A (total power 500W max.)

Maximum ambient: 65°C with 2.5%/°C derating of total power and module current above 50°C

Orientations: Horizontal with chassis lowest, on either side or vertical with the airflow upwards.

Comments: PSU has reverse air.

Model: NV-700 CSS ES5V 12C (NV722DCC and NV7Y019T)

Maximum output: 12V, 37.5A (peak power rating as given in electrical and thermal ratings section on following page)

Maximum ambient: 65°C with 2.5%/°C derating of total power and module current above 50°C

Orientations: Horizontal with chassis lowest, on either side or vertical with the airflow upwards.

Output Interface Assembly:

One of the following output interface assemblies may optionally be fitted:

Wxxx

where xxx is a number between 001 and 999. These assemblies attach to the module output(s) and contain circuitry providing one or more of the following: current sharing, reduced current limit, fusing, sequencing, diode or-ing, module good, filtering, connectors or terminal blocks for outputs or signaling purposes, indicator lamps or LEDs.

Documentation to be made available to the customer detailing ratings of all assembly outputs.

ELECTRICAL AND THERMAL RATINGS

Nominal Input Voltage 100 - 240 Vac

Input Voltage Range 90 - 264 Vac

Input Frequency Range 47 - 440 Hz

Maximum Input Current 11 A rms

Subject to limitations, see table below.

Code	Cooling Option	Input Voltage Range (Vac)	Total output power (W)	Maximum ambient (°C)	Derating
S	Forward airflow standard fan	90 - 99.9	700W continuous (850W peak if 700W average #)	65	2.5% per °C above 45°C
S	Forward airflow standard fan	100 - 149.9	700W continuous (850W peak if 700W average #)	65	2.5% per °C above 50°C
S	Forward airflow standard fan	150 - 264	1150W continuous (1450W peak if 1150W average #)	65	2.5% per °C above 50°C

C, U Customer air Refer to Customer Air Cooling section for details
fan not fitted

Global Option standby outputs (12-13.5V at 1A or 5-5.5V at 2A) should not be included when calculating total PSU output power.

The total output power, module output currents and Global Option output currents are derated by the given value.

The PSU may output the given peak power for up to 10 seconds providing that the average power from the PSU does not exceed the stated value.

Global Options with output voltages between 5.01 and 5.5V have their max. output current linearly derated from 2A at 50°C ambient to 1.4A at 65°C ambient.

Permitted orientations: Horizontal with chassis lowest, on either side or vertical with the airflow upwards.

Single Output Modules:

Module	Nominal Voltage (V)	Voltage Range (V) #	Max. Current
B	3.3	3.135 - 3.6	40A
	5	4.75 - 5.5	4.75 - 5.0V: 40A 5.0 - 5.5V: Linearly derate from 40 to 36A
	8	7 - 9	7 - 8V: 22.5A 8 - 9V: Linearly derate from 22.5 to 20A
	12	12 - 15.5	12 - 12.5V: 19.5A 12.5 - 15.5V: Linearly derate from 19.5 to 15A
	24	24 - 28	24V: 10A 24 - 28V: Linearly derate from 10 to 8A
BH	12	12 - 15.5	12 - 12.5V: 20A 12.5 - 15.5V: Linearly derate from 20 to 15.5A
	24	24 - 28	24V: 10A 24 - 28V: Linearly derate from 10 to 8.5A
C & CM	12	12 - 13.2	12V: 37.5A. Derated to 450W above 12V
	16	15 - 17.6	15 - 16V: 28.12A. Derated to 450W above 16V
	24	24 - 26.4	24V: 18.75A. Derated to 450W above 24V
	30	27 - 32	27V: 16.67A. Derated to 450W above 27V

C & CM modules may output up to 600W for up to 10 seconds providing that the average power from the module does not exceed 450W.

Dual Output Modules:

Dual Output Modules, Output 1

Module	Nominal Voltage	Voltage
--------	-----------------	---------

	Voltage (V)	Range (V) #	Max. Current
DA	12	12.25	3A
DB	3.3	3.135 - 3.6	25A
	5	4.75 - 5.5	25A
	6	5.5 - 6.5	25A
	12	12 - 15.5	12 - 12.5V: 13A
		5.5 - 6.5	12.5 - 15.5V: Linearly derate from 13 to 10A
	24	24 - 28	24 - 25V: 7A
			25 - 28V: Linearly derate from 7 to 6A

Dual Output Modules, Output 2

Module	Nominal Voltage (V)	Voltage Range (V) #	Max. Current (A)	Max. Power(W)
DA	12	(-)11.6 - (-)11.9	1	11.9
DB	5	3.3 - 6	10	60
	12	7 - 15.5	5	60
	24	24 - 32	2	50

Voltage measured at the module power terminals. This voltage must not be exceeded when remote sense is used.

DB modules with 6V nominal channel 1 derated as follows:

Ch.1 : 5.5 - 6V Ch.1 + Ch.2 : 195W total.

Ch.1 : 6.01 - 6.5V Ch.1 + Ch.2 : 170W total.

The DB module may be used with output 1 up to 24V at 8.3A and output 2 up to 16V at 3.13A provided the ambient temperature does not exceed 42°C.

Outputs Connected In Series:

All individual outputs are ES1 (except 24V DB CH2 which is ES2). Outputs connected in series are >ES1 if the total output voltage + 30% of the highest of those outputs exceeds 60Vdc (the 30% addition allows for a single fault in any one individual channel).

If the total voltage of outputs connected in series exceeds the 60Vdc ES1 limit then all outputs must be considered >ES1.

The total voltage of outputs connected in series must not exceed 160V.

All outputs have operational spacings to earth, and due consideration must be given to this in the end product design.

Additional application considerations – (Considerations used to test a component or sub-assembly) -

Customer Air Cooling:

The following method must be used for determining the safe operation of PSUs when C or U options (Customer Air) are fitted, i.e. fan not fitted to PSU. The minimum permitted airflow for customer air cooling is 0.5m/s.

For PSUs and assemblies cooled by customer supplied airflow the components listed in the following table must not exceed the temperatures given. Additionally ratings specified for units with an internal fan shall still be complied with, e.g. mains input voltage range, maximum output power, module voltage / current ratings and maximum ambient temperature. To determine the component temperatures the heating tests shall be conducted in accordance with the requirements of IEC62368-1. Consideration should also be given to the requirements of other safety standards.

Test requirements include: PSU/assembly to be fitted in its end-use equipment and operated under the most adverse conditions permitted in the end-use equipment handbook/specification and which will result in the highest temperatures in the PSU/assembly. To determine the most adverse conditions consideration shall be given to the end use equipment maximum operating ambient, the PSU/assembly loading and input voltage, ventilation, end use equipment orientation, the position of doors & covers, etc. Temperatures shall be monitored using type K fine wire thermocouples (secured with cyanoacrylate adhesive, or similar) placed on the hottest part of the component (out of any direct airflow) and the equipment shall be run until all temperatures have stabilised.

Circuit Ref	Description Max	Temperature (°C)
L2, L3	Filter/PFC assy: Choke winding	155
C1, C3, C4	Filter/PFC assy: X capacitors	100
L1	Filter/PFC assy: Boost choke winding	130
C12, C13	Filter/PFC assy: Electrolytic capacitors	105
T1	Filter/PFC assy: Flyback transformer winding	130
RL1	Filter/PFC assy: Relay	100
TX1, TX2	Modules: Power transformer windings	130
L1, XL1	B, BH & Db module chokes	125
L1	C & CM module chokes	140
T2	Global Options: Transformer winding	130
Various	All other choke & transformer windings	110
Various	All <=10mm diameter electrolytic capacitors	105
Various	All 12.5mm diameter electrolytic capacitors	105

Technical Considerations

- The product was submitted and evaluated for use at the maximum ambient temperature (T_{ma}) permitted by the manufacturer's specification of : 50°C at full load to 65°C maximum (see model, configuration and output details for models and conditions to which the extended ambient applies., Model RA-PFC-001 was tested with 50°C max. ambient temperature.
- The product is intended for use on the following power systems : TN
- Mains supply tolerance (%) or absolute mains supply values : +10%/-10%
- The equipment disconnect device is considered to be : Appliance inlet (if fitted), or provided by the end equipment.
- The following were investigated as part of the protective earthing/bonding : Printed wiring board trace (refer to Enclosure - Schematics + PWB for layouts)
- The following are available from the Applicant upon request : Installation (Safety) Instructions / Manual
- The product was investigated to the following additional standard : EN 62368-1:2014 + A11:2017, CSA CAN/CSA-C22.2 NO. 62368-1 2nd Ed, Issued December 1, 2014
- Multilayer PWB's accepted under CBTR Ref. No. E349607-A23 dated 2014-07-31 and letter report, see enclosure 8-08 of this report.
- All models are suitable for use at an altitude of 5000 metres.

- Components have been evaluated for compliance to IEC or national standards. It shall be noted that provision of clause 4.1.1 was considered for components and subassemblies complying with IEC 60950-1 or IEC 60065 used as part of equipment covered by this standard without further evaluation other than to give consideration to the appropriate use of the component or subassembly in the end-product. Additional certificates may be required at the discretion of the accepting NCB or local authorities.

Engineering Conditions of Acceptability

When installed in an end-product, consideration must be given to the following:

- The following product-line tests are conducted for this product : Earthing Continuity, Electric Strength
- The end-product Electric Strength Test is to be based upon a maximum working voltage of : NV700 Range Primary-Secondary Circuits: 363 Vrms, 650 Vpk. Primary-Earthed Dead Metal: 343 Vrms, 622 Vpk. RA-PFC-001: Primary-Earthed Dead Metal: 240 Vrms, 430 Vpk. Primary-Secondary Circuits: 240V rms, 502 Vpk,
- The following output circuits are at ES1 energy levels : all except 24V DB CH2 which is ES2.
- The following output circuits are at ES2 energy levels : 24V DB CH2
- The following output circuits are at PS3 energy levels : All outputs (by the Manufacturers declaration)
- The maximum investigated branch circuit rating is : 20 A
- The investigated Pollution Degree is : 2
- Proper bonding to the end-product main protective earthing termination is : Required
- An investigation of the protective bonding terminals has : been conducted
- The following input terminals/connectors must be connected to the end-product supply neutral : N
- The following end-product enclosures are required : Fire, Mechanical, Electrical
- The following magnetic devices (e.g. transformers or inductor) are provided with an OBJ2 insulation system with the indicated rating greater than Class A (105°C) : T1, T2, TX1 & TX2 (all class F). See table 1.5.1 for details of insulation systems used.
- The following components require special consideration during end-product Thermal (Heating) tests due to the indicated maximum temperature measurements during component-level testing : Converter: L1 (130°C), L2 (155°C), L3 (155°C), T1 (130°C), C1 (100°C), C3 (100°C), C4 (100°C), RL1 (100°C); Modules: TX1 (130°C), TX2 (130°C), XL1 (125°C), B, BH & DB module L1 (130°C), C & CM Module L1 (140), Global Option T2 (130°C), All electrolytic capacitors (105°C). Also, Refer to additional application considerations.
- The equipment is suitable for direct connection to : AC mains supply (for models fitted with an IEC60320 inlet)
- The power supply was evaluated to be used at altitudes up to : "5,000 m"
- The following output terminals were referenced to earth during performance testing: All secondary outputs and their return lines individually referenced to obtain maximum working voltage.
- The power supply terminals and/or connectors are: Suitable for factory wiring only with the exception of models fitted with option 1, IEC60320 inlet (end face with fan) which are allowed to be accessible.
- The RA-PFC-001 output has an ES3 voltage and must not be made accessible to an end user in the end equipment.
- When operated at a frequency greater than 60Hz, evaluation of the end equipment against the requirements of clause 5.7 must be considered.

ENERGY SOURCE IDENTIFICATION AND CLASSIFICATION TABLE:	
(Note 1: Identify the following six (6) energy source forms based on the origin of the energy.) (Note 2: The identified classification e.g., ES2, TS1, should be with respect to its ability to cause pain or injury on the body or its ability to ignite a combustible material. Any energy source can be declared Class 3 as a worse case classification e.g. PS3, ES3.)	
Electrically-caused injury (Clause 5): (Note: Identify type of source, list sub-assembly or circuit designation and corresponding energy source classification) Example: +5 V dc input ES1	
Source of electrical energy	Corresponding classification (ES)
Primary circuits (not accessible)	ES3
Input connector (stored capacitance)	ES1
B, BH, C, CM, DB, DA modules and all options, secondary circuits before rectification	ES3 (declared)
B, BH, C, CM, DB (except 24V CH2), DA modules and all options, secondary circuits after rectification	ES1 (Energy source diagram A)
BB (6.28 to 7.2, 9.5 to 11, 14 to 18, 24 to 31), BBH, BHB or BHBH (24 to 31), CC or CM (24 to 26.4, 30 to 33) BDB (6.28 to 7.2, 9.5 to 11, 24 to 31) BHDB (24 to 31) secondary circuits after rectification	ES1 (Energy source diagram A)
DB (CH2 24V) BB (48 to 56), BBH, BHB or BHBH (48 to 56), CC or CM (48 to 52.8V, 54 to 64) BDB (48 to 56) BHDB (48 to 56) secondary circuits after rectification	ES2 (Energy source diagram B)
Electrically-caused fire (Clause 6): (Note: List sub-assembly or circuit designation and corresponding energy source classification) Example: Battery pack (maximum 85 watts): PS2	
Source of power or PIS	Corresponding classification (PS)
All Circuits	PS3 declared
Injury caused by hazardous substances (Clause 7) (Note: Specify hazardous chemicals, whether produces ozone or other chemical construction not addressed as part of the component evaluation.) Example: Liquid in filled component Glycol	
Source of hazardous substances	Corresponding chemical
N/A	N/A
Mechanically-caused injury (Clause 8) (Note: List moving part(s), fan, special installations, etc. & corresponding MS classification based on Table 35.) Example: Wall mount unit MS2	
Source of kinetic/mechanical energy	Corresponding classification (MS)
Sharp edges/corners	MS1

ENERGY SOURCE IDENTIFICATION AND CLASSIFICATION TABLE:	
Product mass	MS1
Fan Blades	MS1
Thermal burn injury (Clause 9) (Note: Identify the surface or support, and corresponding energy source classification based on type of part, location, operating temperature and contact time in Table 38.) Example: Hand-held scanner – thermoplastic enclosure TS1	
Source of thermal energy	Corresponding classification (TS)
Metal enclosure/chassis (except Option I front panel and IEC inlet)	TS3 (accessible to skilled persons only, to be considered in end-system)
IEC connector (Option I only)	TS1 (Thermal energy source diagram C)
Radiation (Clause 10) (Note: List the types of radiation present in the product and the corresponding energy source classification.) Example: DVD – Class 1 Laser Product RS1	
Type of radiation	Corresponding classification (RS)
N/A	N/A

ENERGY SOURCE DIAGRAM

Indicate which energy sources are included in the energy source diagram. Insert diagram below

ES PS MS TS RS

Electrical Energy Source Classification

Diagram 'A'

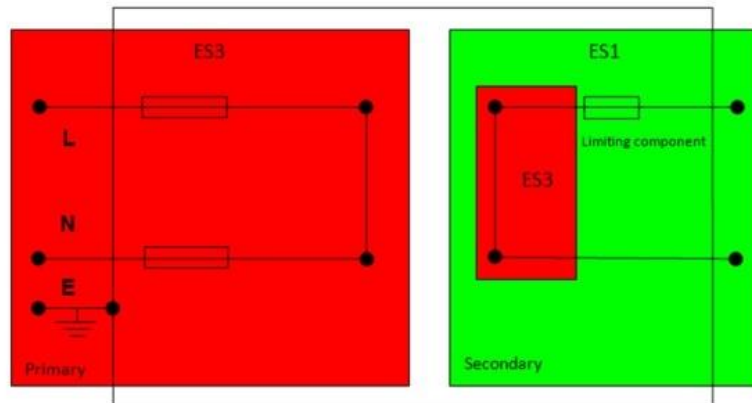
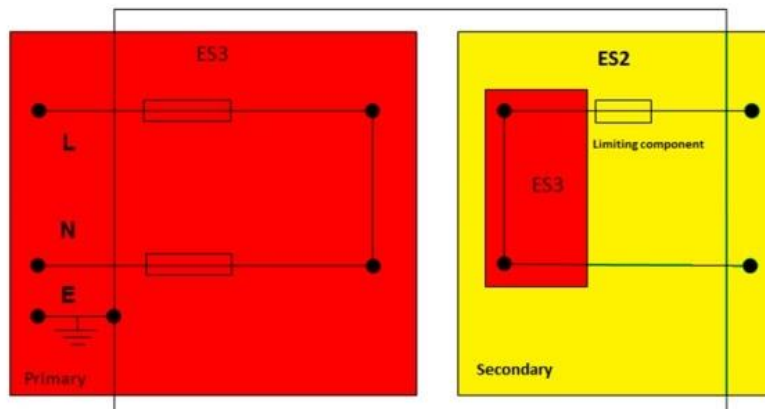
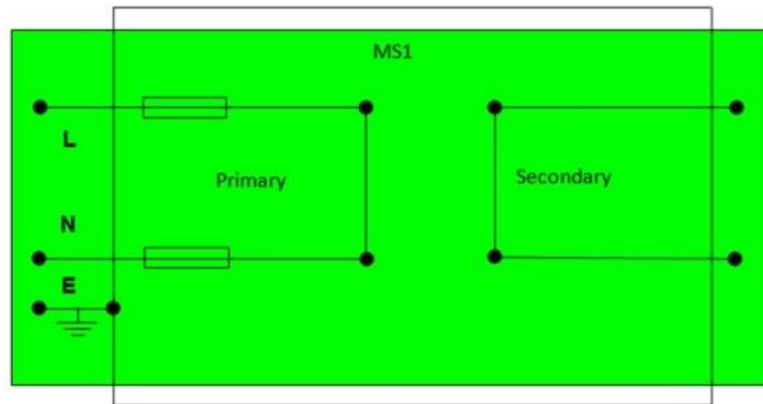

Diagram 'B'



Mechanical Energy Source Classification

All models



Power Source Classification

All models

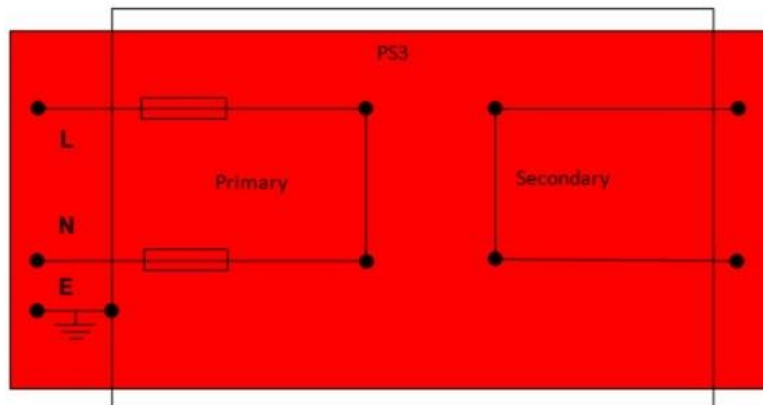

Thermal Energy Source

Diagram 'C'

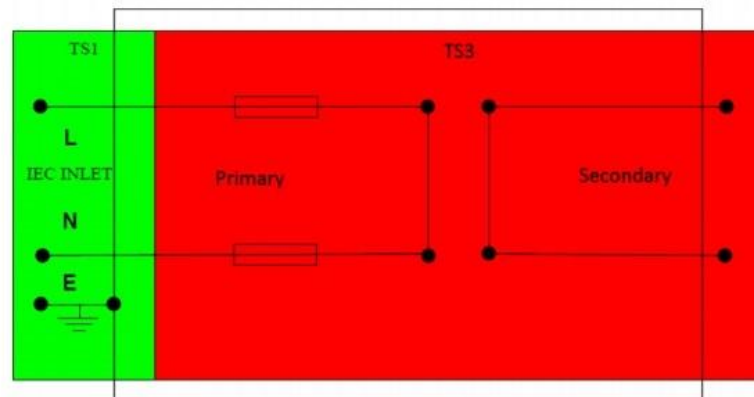

All models (except options I)

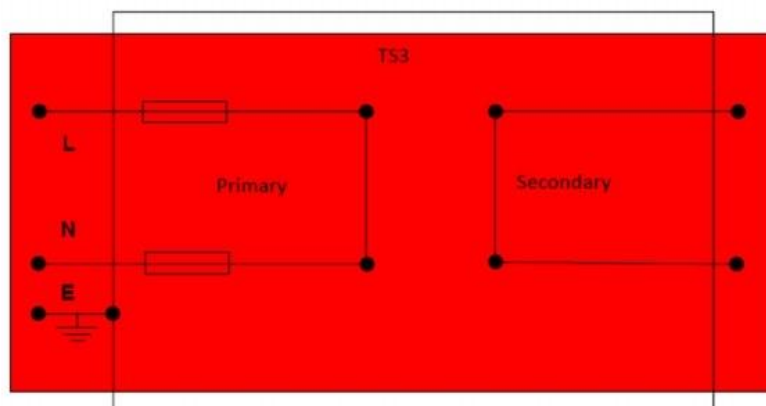

OVERVIEW OF EMPLOYED SAFEGUARDS				
Clause	Possible Hazard			
5.1	Electrically-caused injury			
Body Part (e.g. Ordinary)	Energy Source (ES3: Primary Filter circuit)	Safeguards		
		Basic	Supplementary	Reinforced (Enclosure)
Ordinary Person	ES3: Pins of input terminal (Not accessible, unit for building in except for options I)	Voltage is ES1 after 2 seconds	Voltage is ES1 after 2 seconds in SFC	N/A
Ordinary Person (outputs may be accessible)	ES3: Primary circuits	Creepage and clearance (See insulation diagram Areas B)	Earthed chassis	N/A
Ordinary Person (outputs may be accessible)	ES3: Primary circuits	N/A	N/A	Opto-couplers (See insulation diagram Area C, see Encl. 4-02)
Ordinary Person (outputs may be accessible)	ES3: Primary circuits	N/A	N/A	Clearance & Creepage (See insulation diagram Area E, see Encl. 4-02)
Ordinary Person (outputs may be accessible)	ES3: Primary circuits	N/A	N/A	TX1, TX2, T1, T2 using TIW (See insulation diagram Area D, see Encl. 4-02)
Ordinary Person (outputs may be accessible)	ES3: Primary circuits	N/A	N/A	TX1, Distance Through Insulation (See insulation diagram area D, see Encl. 4-02)
Ordinary Person (outputs may be accessible)	ES3 (Declared): Secondary circuits	N/A	N/A	Distance through

				insulation (2 layers of tape)
6.1	Electrically-caused fire			
Material part (e.g. mouse enclosure)	Energy Source (PS2: 100 Watt circuit)	Safeguards		
		Basic	Supplementary	Reinforced
Transformers T1, T2, TX1, TX2	PS3:Declared	No ignition occurred. No parts exceeding 300°C or 90% of its spontaneous ignition temperature during normal & abnormal conditions	Transformers comply with G.5.3. Control of fire spread achieved with PWBs made of V-1 minimum. CoA requires a fire enclosure be provided by the end equipment manufacturer.	N/A
PWB	PS3:Declared	No ignition occurred. No parts exceeding 300°C or 90% of its spontaneous ignition temperature during normal & abnormal conditions	Control of fire spread achieved with PWBs made of V-1 minimum. CoA requires a fire enclosure be provided by the end equipment manufacturer.	N/A
All other components	PS3:Declared	No ignition occurred. No parts exceeding 300°C or 90% of its spontaneous ignition temperature during normal & abnormal conditions	Mounted on V-1 minimum rated PWB. CoA requires a fire enclosure be provided by the end equipment manufacturer. (Components associated with the MAINS comply with the relevant IEC component standards and/or requirements of this standard.)	N/A
7.1	Injury caused by hazardous substances			
			Safeguards	

Body Part (e.g., skilled)	Energy Source (hazardous material)	Basic	Supplementary	Reinforced
N/A	N/A	N/A	N/A	N/A
8.1	Mechanically-caused injury			
Body Part (e.g. Ordinary)	Energy Source (MS3:High Pressure Lamp)	Safeguards		
		Basic	Supplementary	Reinforced (Enclosure)
Ordinary Person, Skilled Person	MS1: Sharp edges and corners	N/A	N/A	N/A
Ordinary Person, Skilled Person	MS1: Fan Blades	N/A (Mechanical enclosure was used to prevent access. Only accessible to a skilled person after removing metal enclosure, and the moving part is obvious.)	N/A	N/A
Skilled Person	MS1: Mass	N/A <7kg	N/A	N/A
9.1	Thermal Burn			
Body Part (e.g., Ordinary)	Energy Source (TS2)	Safeguards		
		Basic	Supplementary	Reinforced
Ordinary Person	TS1: IEC Inlet and Front Panel. Table 38, row 3 TS1 limit applied: Handle, knobs, grips etc., and external surfaces touched occasionally for very short periods (>1 s and < 10 s).	Under normal, abnormal conditions and SFC, the IEC inlet and front panel continue to comply with a TS1 limit of 60°C.	N/A	N/A
Ordinary Person	TS3: Declared (to be considered in end application). All models except Option I.	N/A	N/A	N/A

10.1	Radiation			
Body Part (e.g., Ordinary)	Energy Source (Output from audio port)	Safeguards		
		Basic	Supplementary	Reinforced
N/A	N/A	N/A	N/A	N/A
Supplementary Information:				
<p>(1) See attached energy source diagram for additional details.</p> <p>(2) "N" – Normal Condition; "A" – Abnormal Condition; "S" Single Fault</p>				