



Test Report issued under the responsibility of:



TEST REPORT IEC 60950-1 Information technology equipment – Safety – Part 1: General requirements	
Report Number	31583701.007
Date of issue	June 26, 2018
Total number of pages	267
Applicant's name	TDK-Lambda Americas, Inc.
Address	401 Mile of Cars Way, Suite 325 National City, CA 91950 USA
Test specification:	
Standard	IEC 60950-1:2005 (Second Edition) + Am 1:2009 + Am 2:2013
Test procedure	CB Scheme
Non-standard test method	N/A
Test Report Form No	IEC60950_1F
Test Report Form(s) Originator	SGS Fimko Ltd
Master TRF	Dated 2014-02
Copyright © 2014 IEC System of Conformity Assessment Schemes for Electrotechnical Equipment and Components (IECEE System). All rights reserved. This publication may be reproduced in whole or in part for non-commercial purposes as long as the IECEE is acknowledged as copyright owner and source of the material. IECEE takes no responsibility for and will not assume liability for damages resulting from the reader's interpretation of the reproduced material due to its placement and context. If this Test Report Form is used by non-IECEE members, the IECEE/IEC logo and the reference to the CB Scheme procedure shall be removed. This report is not valid as a CB Test Report unless signed by an approved CB Testing Laboratory and appended to a CB Test Certificate issued by an NCB in accordance with IECEE 02.	
General disclaimer:	
The test results presented in this report relate only to the object tested. This report shall not be reproduced, except in full, without the written approval of the Issuing CB Testing Laboratory. The authenticity of this Test Report and its contents can be verified by contacting the NCB, responsible for this Test Report.	

Test item description	Power Supply
Trade Mark	<i>TDK-Lambda</i>
Manufacturer	Same as applicant
Model/Type reference	1) TPS3000-24-xxx (xxx = A-Z, 001-999 or blank) 2) TPS3000-48-xxx (xxx = A-Z, 001-999 or blank) 3) TPS4000-24-xxx (xxx = A-Z, 001-999 or blank) 4) TPS4000-12-xxx (xxx = A-Z, 001-999 or blank) 5) TPS4000-48-xxx (xxx = A-Z, 001-999 or blank)
Ratings	1),2) Input: 3 AC 400-480V, 50-60Hz, 6A per phase (Operating Range 360 – 528Vac) 3) Input: 3 AC 400-480V,50-60Hz, 8A per phase, 4600W (Operating Range 360 – 528Vac) 4) Input: 3 AC 400-480V,50-60Hz, 8A per phase, 4600W (Operating Range 360 – 528Vac) 5)) Input: 3 AC 400-480V,50-60Hz, 8A per phase, 4600W (Operating Range 360 – 528Vac) 1) Output: DC 19.2-29.0V, 133.3A max, 3200W max (See Output Rating Table I) 2) Output: DC 38.4-58.0V, 66.7A max, 3200W max (See Output Rating Table II) 3) Output: DC 19.2-28.5V, 170A max, 4000W max (See Output Rating Table III) 4) Output: DC 4-18 V, 170A max, 3000W max (See Output rating Table IV) 5) Output: DC 24-58 V, 85A max, 4000W max (See Output rating Table V)

Output Rating Table I (TPS3000-24-xxx)

Orientation	Output Rating (dc)			
	Voltage (V)	Current (A) Max	Power (W) Max	Ambient (°C) max
1	24.0	133.3	3,200	50
1, 2, 3	24.0	125	3,000	50
1, 2, 3	24.0	100	2,400	60
1, 2, 3	24.0	75	1,800	70
1, 2, 3	19.2	125	2,400	50 and 60
1, 2, 3	19.2	93.8	1,800	70
1, 2, 3	29.0	103.5	3,000	50
1, 2, 3	29.0	82.8	2,400	60
1, 2, 3	29.0	62.1	1,800	70

Output Rating Table II (TPS3000-48-xxx)

Orientation	Output Rating (dc)			
	Voltage (V)	Current (A) Max	Power (W) Max	Ambient (°C) max
1, 2, 3	48.0	66.7	3,200	50
1, 2, 3	48.0	50	2,400	60
1, 2, 3	48.0	37.5	1,800	70
1, 2, 3	38.4	66.7	2561	50
1, 2, 3	38.4	62.5	2400	60
1, 2, 3	38.4	46.9	1,800	70
1, 2, 3	58.0	55.2	3,200	50
1, 2, 3	58.0	41.4	2,400	60
1, 2, 3	58.0	31.1	1,800	70
1, 2, 3	30	66.7	2,001	50 and 60
1, 2, 3	30	60	1,800	70

Orientation are as follows:

1. Horizontal/sideways
2. Vertical - input/output connectors on top, fan at the bottom
3. Vertical - input/output connectors at the bottom, fan on top

Output Rating Table III (TPS4000-24-xxx)

Orientation	Output Rating (dc)			
	Voltage (V)	Current (A) Max	Power (W) Max	Ambient (°C) max
1, 2, 3	24.0	170	4,080	50
1, 2, 3	24.0	136	3,264	60
1, 2, 3	24.0	93.5	2,244	70
1, 2, 3	29.0	140.7	4,080	50
1, 2, 3	29.0	112.6	3,264	60
1, 2, 3	29.0	77.4	2,244	70
1, 2, 3	19.2	170.0	3,264	50 and 60
1, 2, 3	19.2	116.9	2,244	70

Orientation are as follows:

1. Horizontal/sideways
2. Vertical - input/output connectors on top, fan at the bottom
3. Vertical - input/output connectors at the bottom, fan on top

Output Rating Table IV (TPS4000-12-xxx)

Orientation	Output Rating (dc)			
	Voltage (V)	Current (A) Max	Power (W) Max	Ambient (°C) max
1, 2, 3	4	170	680	70
1, 2, 3	12	170	2040	70
1, 2, 3	18	170	3060	60
1, 2, 3	18	124.6	2244	70

Orientation are as follows:

1. Horizontal/sideways
2. Vertical - input/output connectors on top, fan at the bottom
3. Vertical - input/output connectors at the bottom, fan on top.

Output Rating Table V (TPS4000-48-xxx)

Orientation	Output Rating (dc)			
	Voltage (V)	Current (A) Max	Power (W) Max	Ambient (°C) max
1, 2, 3	58	70.3	4,080	50
1, 2, 3	58	56.3	3,264	60
1, 2, 3	58	38.7	2,244	70
1, 2, 3	48	85	4,080	50
1, 2, 3	48	68	3,264	60
1, 2, 3	48	46.8	2,244	70
1, 2, 3	38	85	3,230	60
1, 2, 3	38	59.1	2,244	70
1, 2, 3	24	85	2040	70

Orientation are as follows:

1. Horizontal/sideways
2. Vertical - input/output connectors on top, fan at the bottom
3. Vertical - input/output connectors at the bottom, fan on top

Testing procedure and testing location:	
<input type="checkbox"/>	CB Testing Laboratory:
Testing location/ address	
<input type="checkbox"/>	Associated CB Testing Laboratory:
Testing location/ address	
Tested by (name + signature).....	
Approved by (name + signature).....	
<input checked="" type="checkbox"/> Testing procedure: TMP/CTF Stage 1:	
Testing location/ address TDK-Lambda Americas, Inc. 401 Mile of Cars Way, Suite 325 National City, CA 91950 USA	
Tested by (name + signature)..... Rahul Mehta	
Approved by (name + signature)..... Hai Nguyen	
<input type="checkbox"/> Testing procedure: WMT/CTF Stage 2:	
Testing location/ address	
Tested by (name + signature).....	
Witnessed by (name + signature)	
Approved by (name + signature).....	
<input type="checkbox"/> Testing procedure: SMT/CTF Stage 3 or 4:	
Testing location/ address	
Tested by (name + signature).....	
Witnessed by (name + signature)	
Approved by (name + signature).....	
Supervised by (name + signature)	

List of Attachments (including a total number of pages in each attachment):

Attachment 1 – Group and National Differences – 26 pages

Attachment 2 – Photographs – **8 pages**

Attachment 3 – Schematics and Layers- 8 pages

Attachment 4 – Magnetics Specification – **16 pages**

Attachment 5 – Capacitor Discharge – 3 pages

Summary of testing: Tests were performed to cover the addition of model TPS4000-48-xxx & TPS4000-12-XXX under 31583701.007.**Tests performed (name of test and test clause):**31583701.001

CI 1.6.2 Power Input Measurements
 CI 1.7.11 Durability of Marking Test
 CI 2.1.1.5 c)1) Max V, I and VA Measurement Test
 CI 2.1.1.7 Capacitance Discharge Test
 CI 2.2 Evaluation of Voltage Limiting Components in SELV Circuits
 CI 2.6.3 Earthing Test
 CI 2.9.2 Humidity Test
 CI 2.10.2 Working Voltage Measurement Test
 CI 3.1.9, Termination of conductors
 CI 4.2.2 10N Force Test
 C 4.5 Temperature Test
 CI 4.5.5 Ball Pressure Test
 CI 5.1 Touch Current Test
 CI 5.2 Electric Strength Test
 CI 5.3 Fault Condition Tests
 Annex C Transformer Tests

31583701.003

CI 1.6.2 Input Current
 CI 2.1.1.5 c)1) Max V, I and VA Measurement Test
 CI 2.10.2 Determination of Working Voltage
 CI 2.10.3 Clearance Distances
 CI 2.10.4 Creepage Distances
 CI 4.5.2 Temperature Test
 CI 5.1 Touch Current Test
 CI 5.2 Electric Strength Test
 CI 5.3 Fault Condition Tests
 Annex C Transformer Tests

31583701.005

CI 1.6.2 Input Current
 CI 2.1.1.5 c)1) Max V, I and VA Measurement
 CI 2.10.2 Determination of Working Voltage
 CI 2.10.3 Clearance Distances
 CI 2.10.4 Creepage Distances
 CI 4.5.2 Temperature Test
 CI 5.1 Touch Current Test
 CI 5.2 Electric Strength Test
 CI 5.3 Fault Condition Tests
 Annex C Transformer Tests

Testing location:

TUV Rheinland of North America, Inc.
 1279 Quarry Lane, Suite A, Pleasanton, CA
 94566, USA

TDK-Lambda Americas, Inc.
 401 Mile of Cars Way, Suite 325 National City, CA
 91950 USA

TDK-Lambda Americas, Inc.
 401 Mile of Cars Way, Suite 325 National City, CA
 91950 USA

<p>31583701.007</p> <p>CI 1.6.2 Input Current</p> <p>CI 2.10.2 Determination of Working Voltage</p> <p>CI 4.5.2 Temperature Test</p> <p>Annex C Transformer Tests</p>	<p>TDK-Lambda Americas, Inc.</p> <p>401 Mile of Cars Way, Suite 325 National City,</p> <p>CA 91950 USA</p>
<p>Summary of compliance with National Differences:</p> <p>List of countries addressed</p> <p>EU Group Differences, EU Special National Conditions, DK, IT, SE, US</p> <p>Explanation of used codes: DK = Denmark, IT = Italy, SE = Sweden, US = United States of America</p> <p>The following national differences were considered to IEC 60950-1:2005 (2nd Edition) + Am 1:2009:</p> <p>List of countries addressed: CA, DE, IL, KR</p> <p>Explanation of used codes: CA = Canada, DE = Germany, IL = Israel, KR = Republic of Korea</p> <p>The following national differences were considered to IEC 60950-1:2005 (2nd Edition):</p> <p>List of countries addressed: CN</p> <p>Explanation of used codes: CN = China</p> <p>The following national differences were considered to IEC 60950-1:2001 (1st Edition):</p> <p>List of countries addressed: JP</p> <p>Explanation of used codes: JP = Japan</p> <p><input checked="" type="checkbox"/> The product fulfils the requirements of IEC 60950-1:2005 + Am 1:2009 + Am 2:2013; EN 60950-1:2006 + A11:2009 + A1:2010 + A12:2011 + A2:2013.</p>	

Copy of marking plate:

The artwork below may be only a draft. The use of certification marks on a product must be authorized by the respective NCBS that own these marks.

TDK-Lambda
TPS3000-24

INPUT: 3 PHASE ~ 400 - 480 V
6A / PHASE, 50 - 60 HZ
INPUT POWER : 3640W MAX.
DC OUTPUT POWER: 3200W MAX.
19.2 - 28.5 VDC (---) @ 133.3A MAX.

UL **US**
CE

 Type Approved
Safety
Regular Production
Surveillance
www.tuv.com
ID 1234500074

SEE MANUAL FOR
CONNECTIONS AND
OTHER INPUT/OUTPUT
DE-RATING INFORMATION

REV. **A**

MADE IN
XXXXXXXXXX

XXXXXXXXXXXXXX

FW: XX

TDK-Lambda
TPS3000-48

INPUT: 3 PHASE ~ 400 - 480 V
6A / PHASE, 50 - 60 HZ
INPUT POWER : 3640W MAX.
DC OUTPUT POWER: 3200W MAX.
38.4 - 58.0 VDC (---) @ 62.5A MAX.

UL **US**
CE

 Type Approved
Safety
Regular Production
Surveillance
www.tuv.com
ID 1234500074

SEE MANUAL FOR
CONNECTIONS AND
OTHER INPUT/OUTPUT
DE-RATING INFORMATION

REV. **X1**

MADE IN
XXXXXXXXXX

XXXXXXXXXXXXXX

FW: XX

TDK-Lambda TPS4000-24



INPUT: 3 PHASE ~ 400 - 480 V
8A / PHASE, 50 - 60 HZ
INPUT POWER : 4600W MAX.
DC OUTPUT POWER: 4000W MAX.
19.2 - 28.5 VDC (---) @ 166A MAX.



SEE MANUAL FOR
CONNECTIONS AND
OTHER INPUT/OUTPUT
DE-RATING INFORMATION

REV. **X2**



MADE IN
XXXXXXXX

XXXXXXXXXXXX

FW: 1.3

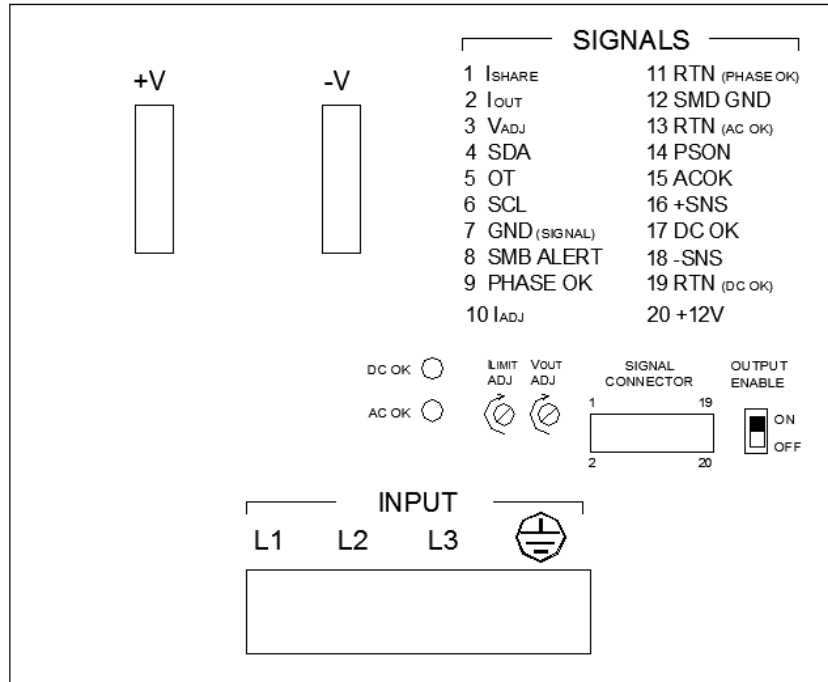

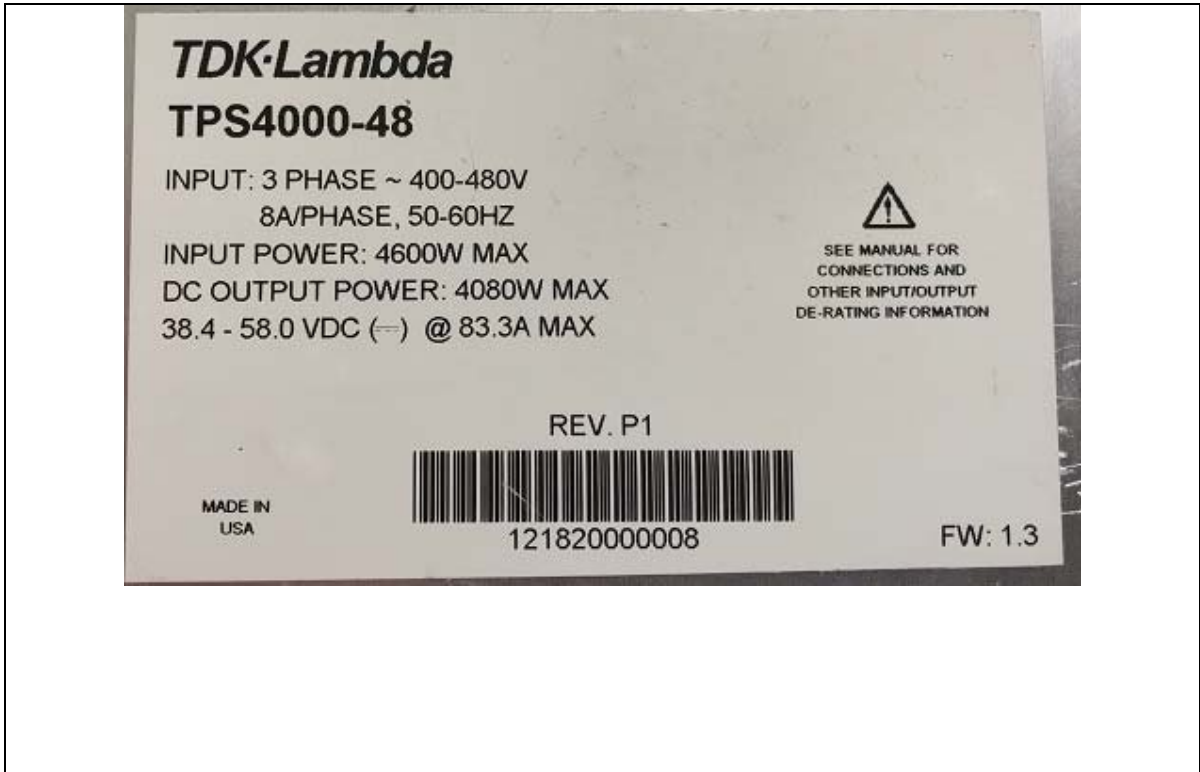

Test item particulars	
Equipment mobility	<input type="checkbox"/> movable <input type="checkbox"/> hand-held <input type="checkbox"/> transportable <input type="checkbox"/> stationary <input checked="" type="checkbox"/> for building-in <input type="checkbox"/> direct plug-in
Connection to the mains	<input type="checkbox"/> pluggable equipment <input type="checkbox"/> type A <input type="checkbox"/> type B <input checked="" type="checkbox"/> permanent connection <input type="checkbox"/> detachable power supply cord <input type="checkbox"/> non-detachable power supply cord <input type="checkbox"/> not directly connected to the mains
Operating condition	<input checked="" type="checkbox"/> continuous <input type="checkbox"/> rated operating / resting time:
Access location	<input type="checkbox"/> operator accessible <input type="checkbox"/> restricted access location <input checked="" type="checkbox"/> Unit is for building-in. End use to consider
Over voltage category (OVC)	<input type="checkbox"/> OVC I <input checked="" type="checkbox"/> OVC II <input type="checkbox"/> OVC III <input type="checkbox"/> OVC IV <input type="checkbox"/> other:
Mains supply tolerance (%) or absolute mains supply values	+/-10%
Tested for IT power systems	<input type="checkbox"/> Yes <input checked="" type="checkbox"/> No
IT testing, phase-phase voltage (V)	
Class of equipment	<input checked="" type="checkbox"/> Class I <input type="checkbox"/> Class II <input type="checkbox"/> Class III <input type="checkbox"/> Not classified
Considered current rating of protective device as part of the building installation (A)	20
Pollution degree (PD)	<input type="checkbox"/> PD 1 <input checked="" type="checkbox"/> PD 2 <input type="checkbox"/> PD 3
IP protection class	IPX0
Altitude during operation (m)	4000
Altitude of test laboratory (m)	50
Mass of equipment (kg)	1) 3.4, 2) 3.6, 3) 3.9

Possible test case verdicts:	
- test case does not apply to the test object	N/A
- test object does meet the requirement.....	P (Pass)
- test object does not meet the requirement	F (Fail)
Testing	
Date of receipt of test item	11/03/2015 (31583701.001) 5/19/2016 (31583701.003) 11/30/2017 (31583701.005) 05/02/2018 (31583701.007)
Date (s) of performance of tests	11/03/2015 – 11/05/2016 (31583701.001) 5/19/2016 (31583701.003) 11/30/2017 (31583701.005) 05/02/18- 05/11/18 (31583701.007)
General remarks:	

"(See Enclosure #)" refers to additional information appended to the report.
 "(See appended table)" refers to a table appended to the report.

Throughout this report a comma / point is used as the decimal separator.

Manufacturer's Declaration per sub-clause 4.2.5 of IECCE 02:

The application for obtaining a CB Test Certificate includes more than one factory location and a declaration from the Manufacturer stating that the sample(s) submitted for evaluation is (are) representative of the products from each factory has been provided

- Yes
- Not applicable

When differences exist; they shall be identified in the General product information section.

Name and address of factory (ies) TDK-Lambda Malaysia Sdn Bhd
 Lot 2 & 3, Batu 9 3/4
 Kawasan Perindustrian
 Bandar Baru Jaya Gading
 26070 Kuantan, Malaysia

General product information:

31583701.007

This is the Third amendment to the original CB report 31583701.001. This report also covers the addition a new model TPS4000-12-xxx & TPS4000-48-xxx. Model TPS4000-12-xxx & TPS4000-48-xxx are identical to Model: TPS4000-24-xxx, but with 12V & 48V output. The output power is the same as previous model. The circuitry of the output board has been updated.

31583701.005

This is the second amendment to the original CB report 31583701.001. This report also covers the addition a new model TPS4000-24-xxx. Model TPS4000-24-xxx was designed to be a higher wattage version of the existing model TPS3000-24-xxx. The input current for model TPS4000-24-xxx has been increased to 8A per phase and the output rating is 'DC 19.2-28.5V, 166A max, 4000W'. The input board has been updated to handle the increased current generation and to include a fault protection circuit. The mains transformers (T303 and T305) on the output board are identical to the mains transformers for model TPS3000-24. The circuitry of the output board has been updated to account for higher currents.

31583701.003

This is the first amendment to the original CB report 31583701.001. This report also covers the addition a new model TPS3000-48-xxx. It was designed to be a higher voltage version of the existing model TPS3000-24-xxx. The input ratings will remain the same and output rating is 'DC 38.4-58.0V, 66.7A max, 3200W max'. Both models use the same input board. The output board of the new model use two primary side chokes with an extra turn (3 vs 2 when compared to TPS3000-24-xxx) and different mains transformer. The construction of the mains transformer is identical, except for the tapping of the secondary. The control circuitry of the output board's secondary has also changed to account for the higher voltage.

31583701.001

Original report. The equipment is a switch-mode power supply. It is fully enclosed, with single output and with forced air cooling.

Conditions of Acceptability:

1. The equipment is considered to operate under the conditions of:
 - Pollution Degree 2 environment
 - Equipment mobility: Component for building-in
 - Class of Equipment: Class I (grounded)
 - Operating altitude: 4000 meters
2. Rated ambient 50°C at full load (3,200 and 3,000W), 60°C at 80% load (2,400 W), 70°C at 60% load (1,800 W).
3. Fire enclosure requirements must be addressed in the end product.
4. Output is considered to be at hazardous energy levels.
5. Heating test must be re-evaluated in the end use application.
6. All fuses used are non-user accessible and replaceable UL/CSA fuses.

Abbreviations used in the report:

- normal conditions	N.C.	- single fault conditions	S.F.C
- functional insulation	OP	- basic insulation	BI
- double insulation	DI	- supplementary insulation	SI
- between parts of opposite polarity	BOP	- reinforced insulation	RI

Indicate used abbreviations (if any)

IP - Internal protection operated (list component)

CT - Constant temperatures were obtained

TW - Transformer winding opened

CD - Components damaged (list damaged components)

NB - No indication of dielectric breakdown

YB - Dielectric breakdown (indicate time and location)

NC - Cheesecloth remained intact

YC - Cheesecloth charred or flamed

NT - Tissue paper remained intact

YT - Tissue paper charred or flamed