

CN150B110-*

EVALUATION DATA

型式データ

INDEX

1. 評価方法	Evaluation Method	PAGE
1.1	測定回路 Measurement Circuits	T-1
	(1) 静特性、過電流保護特性、出力リップル・ノイズ波形 Steady state characteristics, Over current protection (OCP) characteristics, and Output ripple and noise waveform	
	(2) 過渡応答、過電圧保護特性、その他 Dynamic response, Over voltage protection (OVP) characteristics and Other characteristics	
	(3) 入力サージ電流(突入電流)特性 Inrush current characteristics	
	(4) EMI 特性 Electro-Magnetic Interference characteristics	
1.2	使用測定機器 List of equipment used	T-3
2.	特性データ Characteristics	
2.1	静特性 Steady state data	
	(1) 入力変動、負荷変動、温度変動 Line regulation, Load regulation, Temperature drift	T-4
	(2) 出力電圧、出力リップル・ノイズ電圧 対 入力電圧 Output voltage and Output ripple and noise voltage vs. Input voltage	T-7
	(3) 入力電流、効率 対 出力電流 Input current and Efficiency vs. Output current	T-10
	(4) 効率 対 入力電圧 Efficiency vs. Input voltage	T-13
	(5) 効率 対 ベースプレート温度 Efficiency vs. Base-plate temperature	T-16
	(6) 起動、停止電圧特性 Start and Stop voltage characteristics	T-19
2.2	待機電力特性 Standby power characteristics	T-22
2.3	通電ドリフト特性 Warm up voltage drift characteristics	T-25
2.4	過電流保護特性 Over current protection (OCP) characteristics	T-28
2.5	過電圧保護特性 Over voltage protection (OVP) characteristics	T-31
2.6	出力立ち上がり、立ち下がり特性 Output rise and fall characteristics	T-34
2.7	過渡応答(負荷急変)特性 Dynamic load response characteristics	T-46
2.8	入力サージ電流(突入電流)特性 Inrush current characteristics	T-49
2.9	出力リップル・ノイズ波形 Output ripple and noise waveform	T-50
2.10	EMI特性 Electro-Magnetic Interference characteristics	T-53

使用記号 Terminology used

Definition		
V_{in}	入力電圧	Input voltage
V_o	出力電圧	Output voltage
V_{cnt}	CNT電圧	CNT voltage
I_{in}	入力電流	Input current
I_o	出力電流	Output current
T_{bp}	ベースプレート温度	Base-plate temperature
T_a	周囲温度	Ambient temperature
f	周波数	Frequency

1. 評価方法 Evaluation Method

1.1 測定回路 Measurement Circuits

- (1) 静特性、過電流保護特性、出力リップル・ノイズ波形
Steady state characteristics, Over current protection (OCP) characteristics and Output ripple and noise waveform

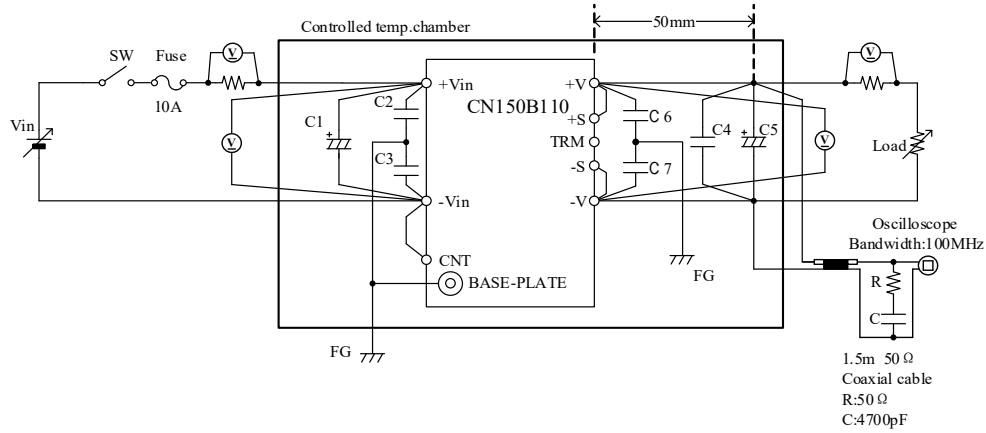

- (2) 過渡応答、過電圧保護特性、その他
Dynamic response, Over voltage protection (OVP) characteristics and Other characteristics

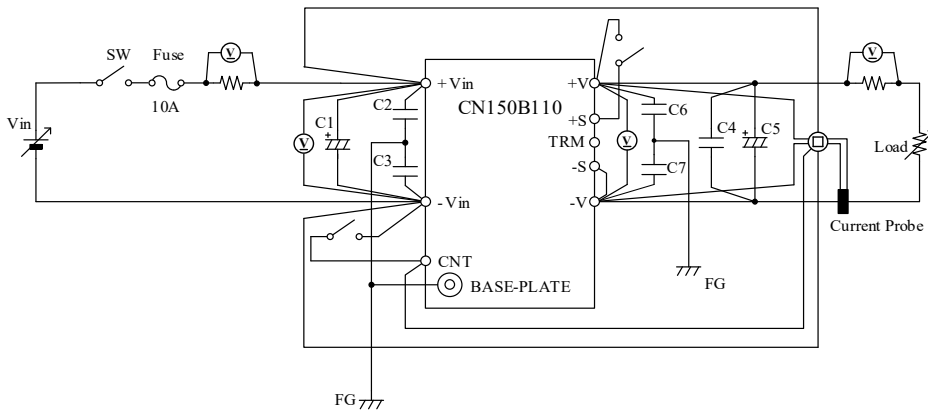

- (3) 入力サージ電流 (突入電流) 特性
Inrush current characteristics

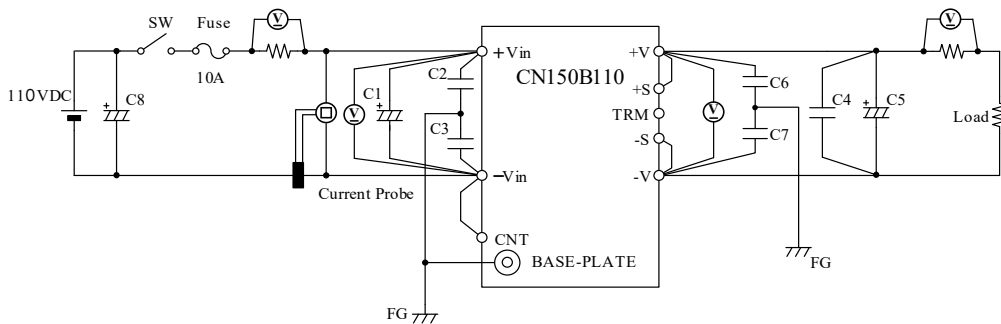

C1 : 100μF Electrolytic Capacitor	C5 : 5V- 1000μF Solid Capacitor
C2,C3 : 4700pF Ceramic Capacitor	: 12V- 680μF Solid Capacitor
C4 : 2.2μF Ceramic Capacitor	: 15V- 680μF Solid Capacitor
C6,C7 : 0.022μF Film Capacitor	: 24V- 220μF Electrolytic Capacitor
C8 : 20000μF Electrolytic Capacitor	: 48V- 220μF x2 Series Electrolytic Capacitor

(4) EMI特性 Electro-Magnetic Interference characteristics

(a) 雑音端子電圧 (帰還ノイズ) Conducted Emission Noise

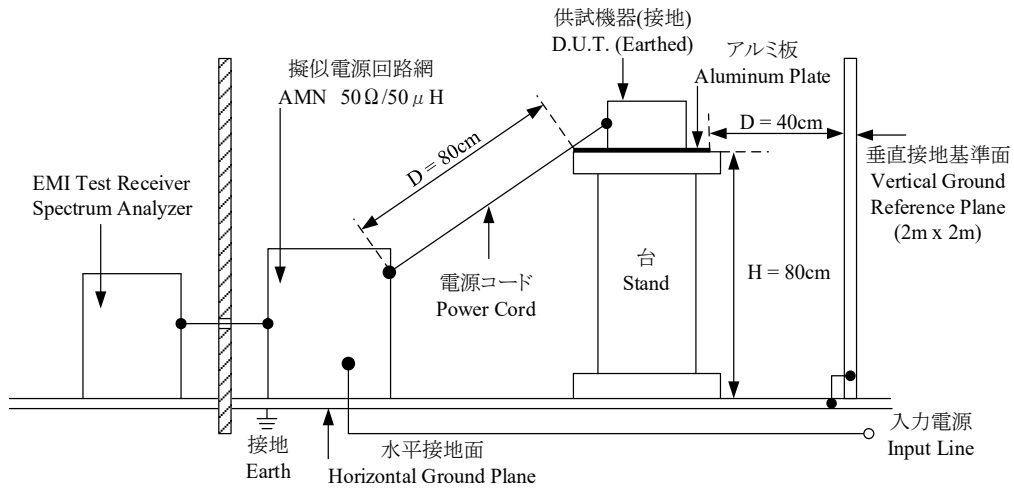

(b) 雑音電界強度 (輻射ノイズ) Radiated Emission Noise

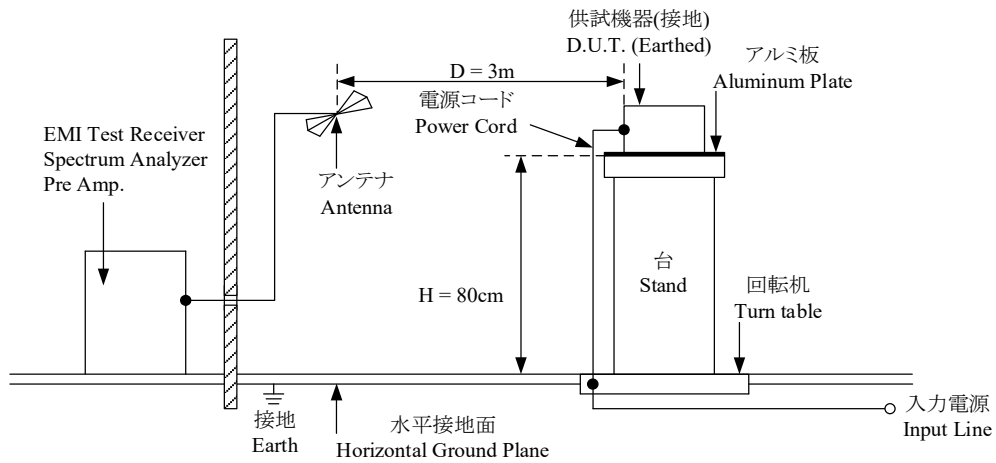

*入出力ケーブルとしてシールドケーブルを使用
Shielded cable used to input and output cable.

VCCI class A対応アプリケーションシステム
VCCI class A application system

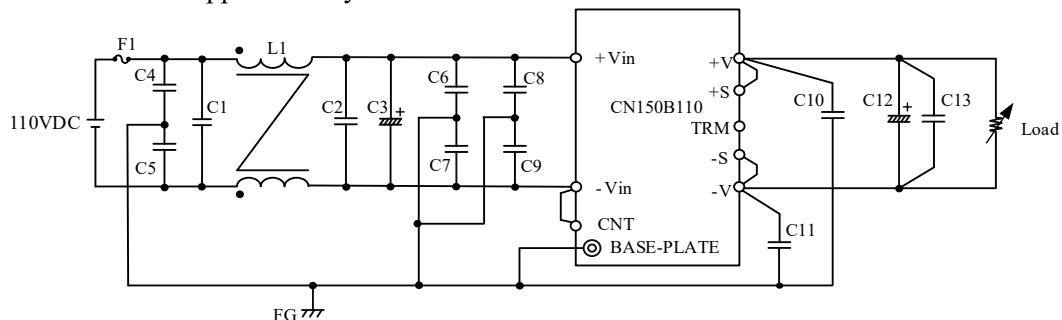

- | | |
|--|---|
| C1 : 1.5μF Film Capacitor | C12 : 5V- 1000μF Solid Capacitor |
| C2 : 1.5μF Film Capacitor | : 12V- 680μF Solid Capacitor |
| C3 : 100μF Electrolytic Capacitor | : 15V- 680μF Solid Capacitor |
| C4,C5 : 100pF Ceramic Capacitor | : 24V- 220μF Electrolytic Capacitor |
| C6,C7,C8,C9 : 4700pF Ceramic Capacitor | : 48V- 220μF x2 Series Electrolytic Capacitor |
| C10,C11 : 0.022μF Film Capacitor | F1 : 10A |
| C13 : 2.2μF Ceramic Capacitor | L1 : 2mH |

*詳細な周辺パラメータ情報(参照用)

The detailed peripheral parameter information (for reference)

	SYMBOL	PRODUCT TYPE	ITEM DESCRIPTION	NOTE	MANUFACTURER	
1	F1	Fuse	WN30-10-P	500VDC, 10A	WALTER	
2	C1,C2	Cap., Film	MDX22W155K-F	450VDC , 1.5 μ	NITSUKO	
3	C3	Cap., Elect	EKXJ201ELL101MJ35S	200V, 100 μ	NI-CHEMI	
4	C4,C5	Cap.,Ceramic(AC)	DE1B3RA101KJ4BN01F	250V, 100p	MURATA	
5	C6,C7,C8,C9	Cap.,Ceramic(AC)	DE1E3KX472MJ4BN04F	250V, 4,700p	MURATA	
6	C10,C11	Cap., Film	MMCF0630K22300000100	630V, 0.022 μ	NISSEI	
7	C12	5V Model	APSG160ELL102MJB5S	16V, 1,000 μ	NI-CHEMI	
8		12V Model	APSG250ELL681MJB5S	25V, 680 μ	NI-CHEMI	
9		15V Model	APSG250ELL681MJB5S	25V, 680 μ	NI-CHEMI	
10		24V Model	Cap., Elect	ELXY500ELL221MJ25S	50V, 220 μ	NI-CHEMI
11		48V Model	Cap., Elect \times 2 Series	ELXY500ELL221MJ25S	50V, 220 μ \times 2	NI-CHEMI
12	C13	MLCC	C3225X7R2A225KT	100V, 2.2 μ	TDK	
13	L1	Noise Filter Coil	TC580020S	2mH, 8A	TNC	

1.2 使用測定機器 List of equipment used

	EQUIPMENT USED	MANUFACTURER	MODEL NO.
1	AMN	SCHWARZBECK	NNLK8121
2	ANTENNA(BI-LOG ANTENNA)	TESEQ	CBL6111D
3	CONTROLLED TEMP. CHAMBER	ESPEC CORP.	SU-662
4	CURRENT PROBE	YOKOGAWA ELECT.	701930
5	CURRENT PROBE AMPLIFIER	YOKOGAWA ELECT.	700938
6	CVCF	KIKUSUI	PCR2000L
7	DC POWER SUPPLY	TDK-Lambda	GEN200-25
8	DIGITAL MULTIMETER	Agilent	34970A
9	DIGITAL POWER METER	YOKOGAWA ELECT.	WT210
10	DIGITAL STORAGE OSCILLOSCOPE	YOKOGAWA ELECT.	DLM2054
11	DYNAMIC DUMMY LOAD	Chroma	63203
12	EMI TEST RECEIVER SPECTRUM ANALYZER	ROHDE & SCHWARZ	ESCI
13	PRE AMP.	SONOMA	310N
14	SHUNT RESISTER	YOKOGAWA ELECT.	2215

2. 特性データ Characteristics

2.1 静特性 Steady state data

(1) 入力変動、負荷変動、温度変動 Line regulation, Load regulation, Temperature drift

5V

1. Line regulation and Load regulation

Condition Tbp : 25°C

Io \ Vin	43VDC	72VDC	110VDC	160VDC	Line regulation	
0%	4.989V	4.989V	4.989V	4.989V	0mV	0.000%
50%	4.989V	4.989V	4.989V	4.989V	0mV	0.000%
100%	4.988V	4.988V	4.988V	4.988V	0mV	0.000%
Load regulation	1mV	1mV	1mV	1mV		
	0.020%	0.020%	0.020%	0.020%		

2. Temperature drift

Conditions Vin : 110VDC

Io : 100%

Tbp	-40°C	+25°C	+100°C	Temperature stability	
Vo	4.995V	4.988V	4.991V	7mV	0.144%

12V

1. Line regulation and Load regulation

Condition Tbp : 25°C

Io \ Vin	43VDC	72VDC	110VDC	160VDC	Line regulation	
0%	11.955V	11.954V	11.955V	11.955V	1mV	0.008%
50%	11.954V	11.954V	11.954V	11.954V	0mV	0.000%
100%	11.953V	11.954V	11.954V	11.954V	1mV	0.008%
Load regulation	2mV	0mV	1mV	1mV		
	0.017%	0.000%	0.008%	0.008%		

2. Temperature drift

Conditions Vin : 110VDC

Io : 100%

Tbp	-40°C	+25°C	+100°C	Temperature stability	
Vo	11.962V	11.954V	11.959V	8mV	0.067%

(1) 入力変動、負荷変動、温度変動 Line regulation, Load regulation, Temperature drift

15V

1. Line regulation and Load regulation

Condition Tbp : 25°C

Io \ Vin	43VDC	72VDC	110VDC	160VDC	Line regulation	
0%	14.933V	14.933V	14.932V	14.932V	1mV	0.007%
50%	14.932V	14.933V	14.932V	14.933V	1mV	0.007%
100%	14.932V	14.932V	14.933V	14.932V	1mV	0.007%
Load regulation	1mV	1mV	1mV	1mV		
	0.007%	0.007%	0.007%	0.007%		

2. Temperature drift

Conditions Vin : 110VDC

Io : 100%

Tbp	-40°C	+25°C	+100°C	Temperature stability	
Vo	14.930V	14.933V	14.948V	18mV	0.117%

24V

1. Line regulation and Load regulation

Condition Tbp : 25°C

Io \ Vin	43VDC	72VDC	110VDC	160VDC	Line regulation	
0%	24.007V	24.007V	24.007V	24.007V	0mV	0.000%
50%	24.006V	24.006V	24.006V	24.007V	1mV	0.004%
100%	24.006V	24.006V	24.006V	24.006V	0mV	0.000%
Load regulation	1mV	1mV	1mV	1mV		
	0.004%	0.004%	0.004%	0.004%		

2. Temperature drift

Conditions Vin : 110VDC

Io : 100%

Tbp	-40°C	+25°C	+100°C	Temperature stability	
Vo	24.035V	24.006V	24.002V	33mV	0.137%

(1) 入力変動、負荷変動、温度変動 Line regulation, Load regulation, Temperature drift

48V

1. Line regulation and Load regulation

Condition Tbp : 25°C

Io \ Vin	43VDC	72VDC	110VDC	160VDC	Line regulation	
0%	48.025V	48.025V	48.025V	48.025V	0mV	0.000%
50%	48.024V	48.024V	48.024V	48.024V	0mV	0.000%
100%	48.022V	48.023V	48.023V	48.022V	1mV	0.007%
Load regulation	3mV	2mV	2mV	3mV		
	0.020%	0.013%	0.013%	0.020%		

2. Temperature drift

Conditions Vin : 110VDC

Io : 100%

Tbp	-40°C	+25°C	+100°C	Temperature stability	
Vo	48.058V	48.023V	48.034V	35mV	0.073%

(2) 出力電圧、出力リップル・ノイズ電圧 対 入力電圧

Output voltage and Output ripple and noise voltage vs. Input voltage

Conditions I_o : 100 %
 T_{bp} : -40 °C - - - -
 : 25 °C - · - · -
 : 100 °C ————

5V

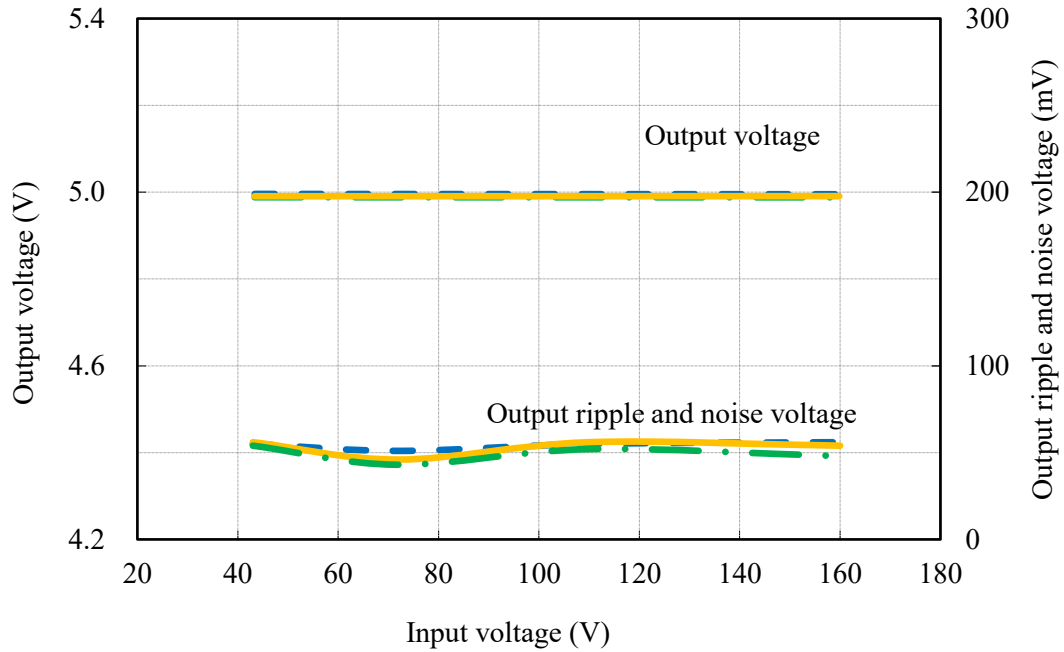

12V

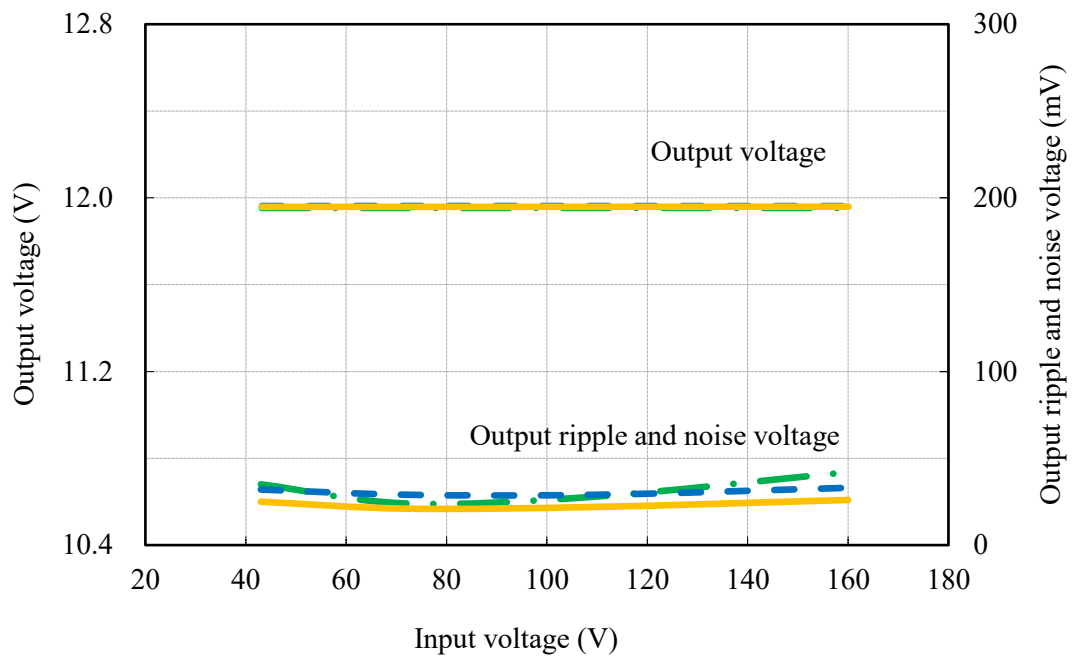

(2) 出力電圧、出力リップル・ノイズ電圧 対 入力電圧

Output voltage and Output ripple and noise voltage vs. Input voltage

Conditions I_o : 100 %
 T_{bp} : -40 °C - - - -
 : 25 °C - · - · -
 : 100 °C ————

15V

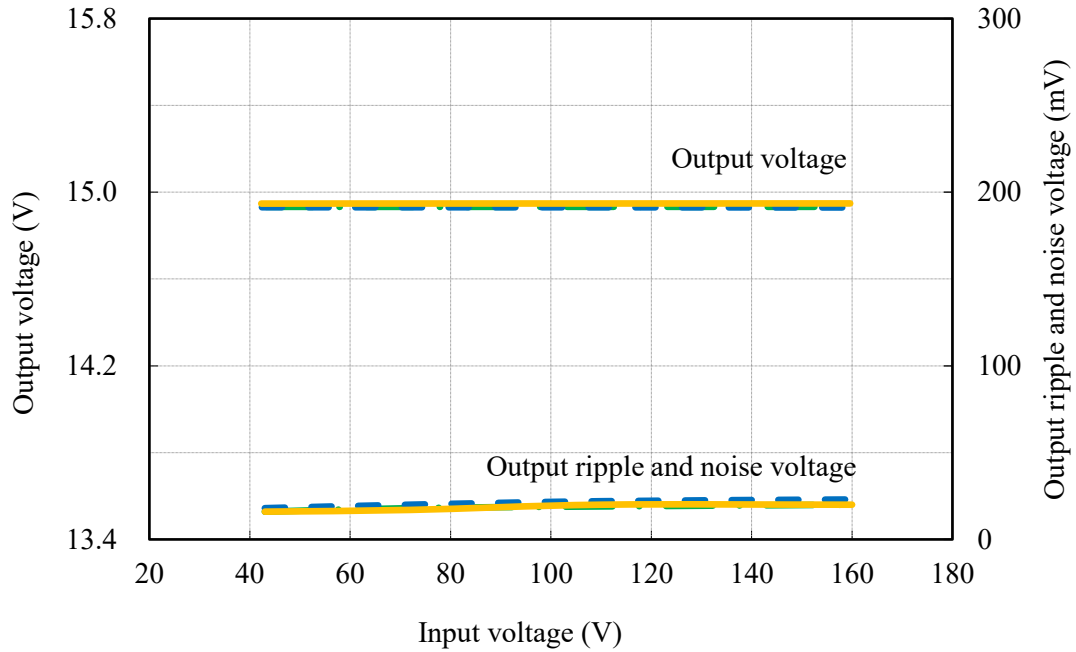

24V

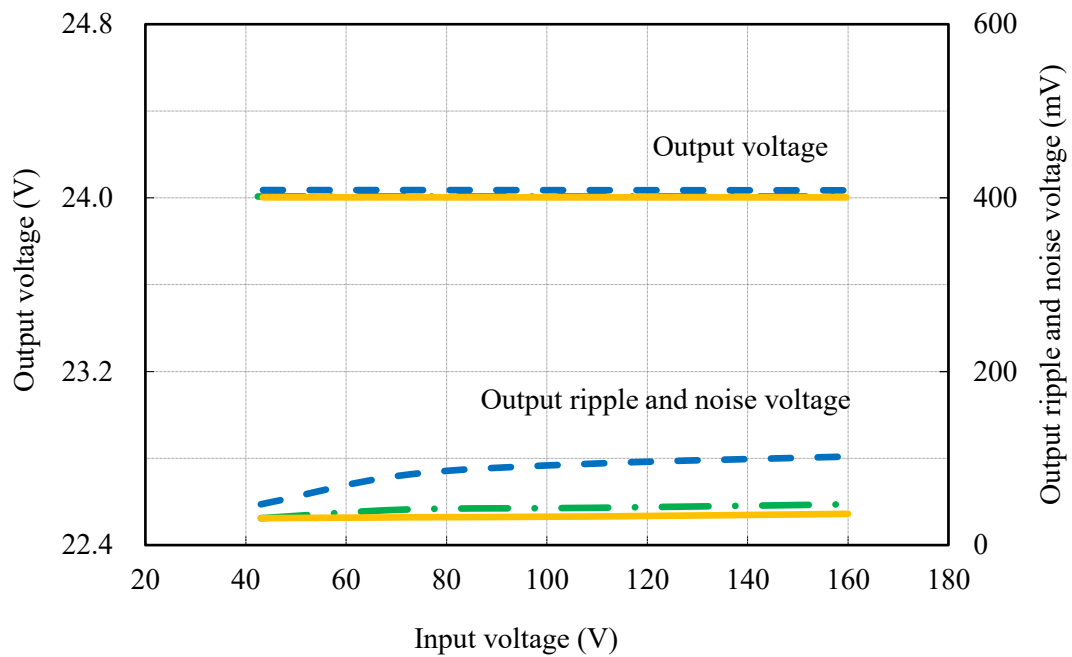

(2) 出力電圧、出力リップル・ノイズ電圧 対 入力電圧

Output voltage and Output ripple and noise voltage vs. Input voltage

Conditions I_o : 100 %
 T_{bp} : -40 °C ---
 : 25 °C -.-
 : 100 °C ---

48V

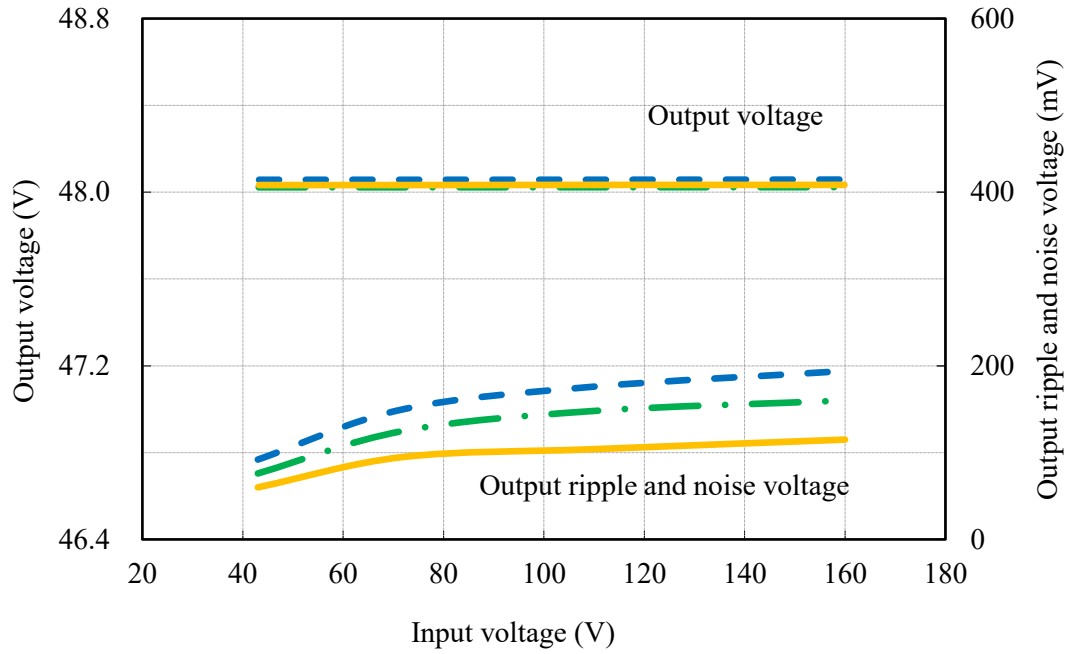

(3) 入力電流、効率 対 出力電流

Input current and Efficiency vs. Output current

Conditions Vin : 43 VDC ---
 : 72 VDC —
 : 110 VDC - · - ·
 : 160 VDC - · - ·
 Tbp : 25 °C

5V

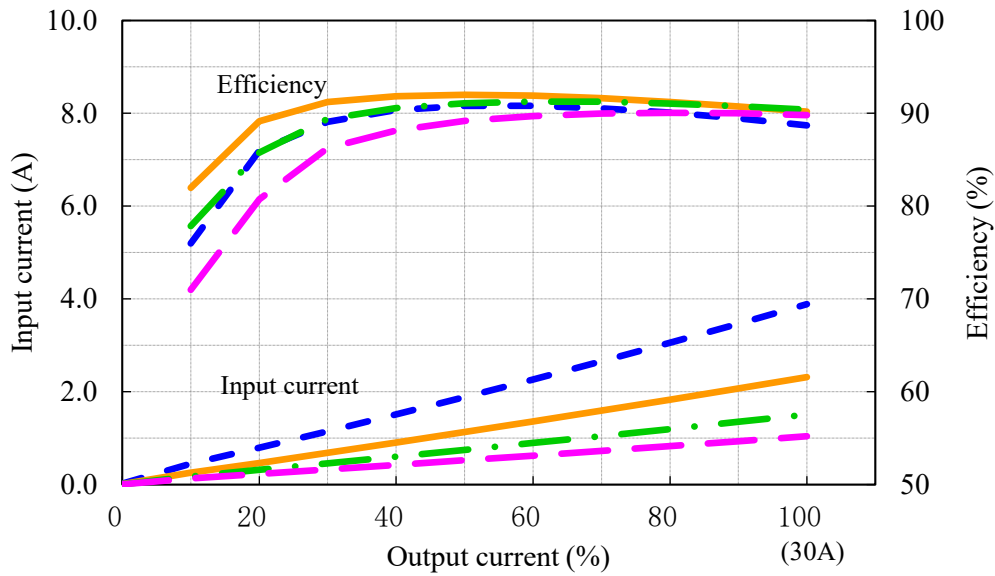

12V

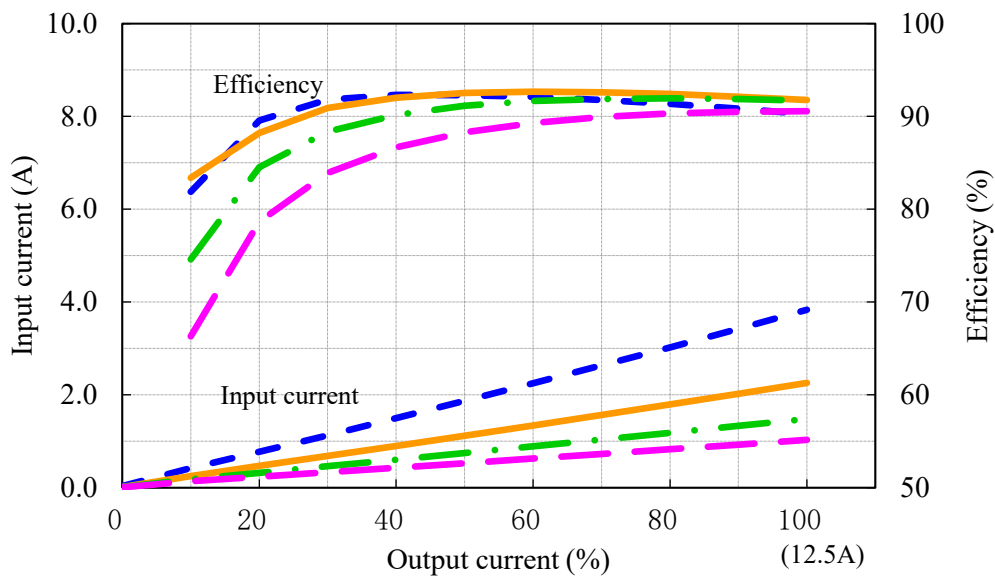

(3) 入力電流、効率 対 出力電流

Input current and Efficiency vs. Output current

Conditions Vin : 43 VDC ---
 : 72 VDC —
 : 110 VDC - · -
 : 160 VDC - · -
 Tbp : 25 °C

15V

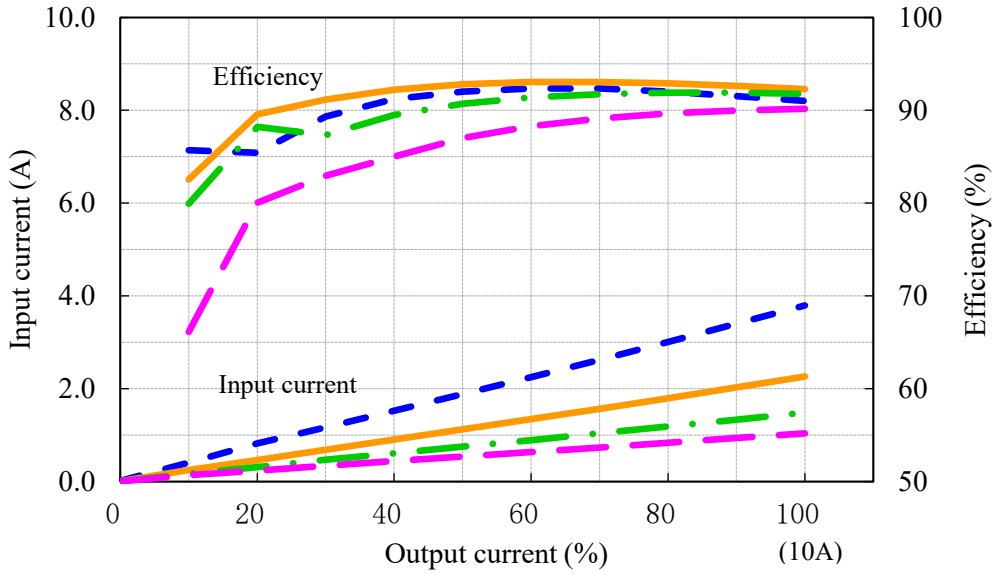

24V

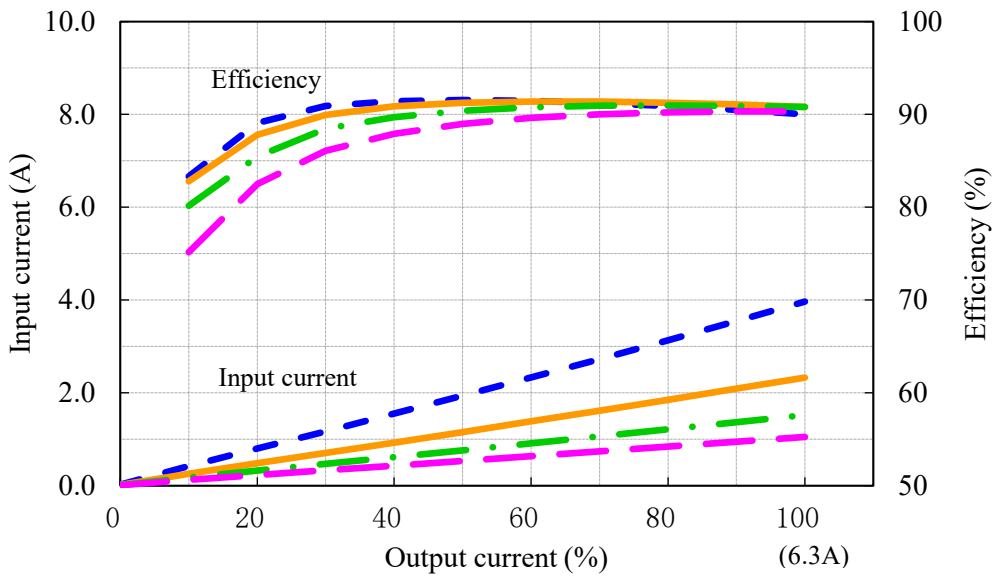

(3) 入力電流、効率 対 出力電流

Input current and Efficiency vs. Output current

Conditions Vin : 43 VDC ---
 : 72 VDC —
 : 110 VDC - · - ·
 : 160 VDC - · - ·
 Tbp : 25 °C

48V

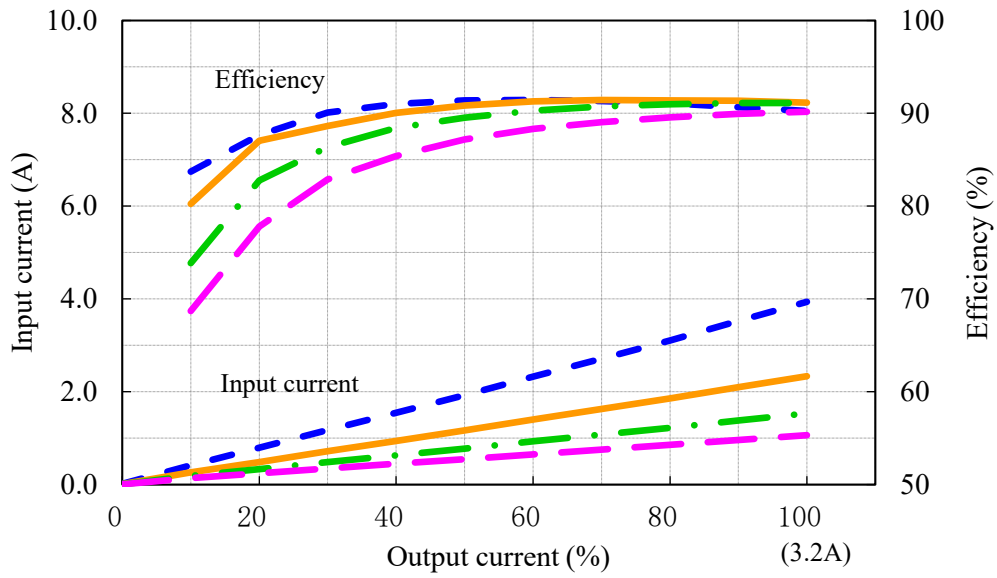

(4) 効率 対 入力電圧

Efficiency vs. Input voltage

Conditions I_o : 50 % - - - -
 : 100 % ————
 T_{bp} : 25 °C

5V

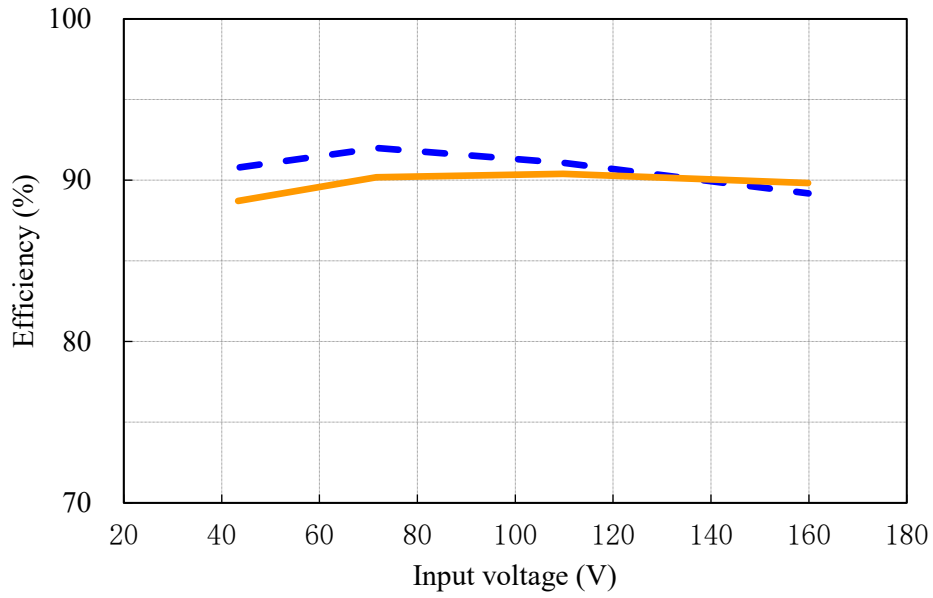

12V

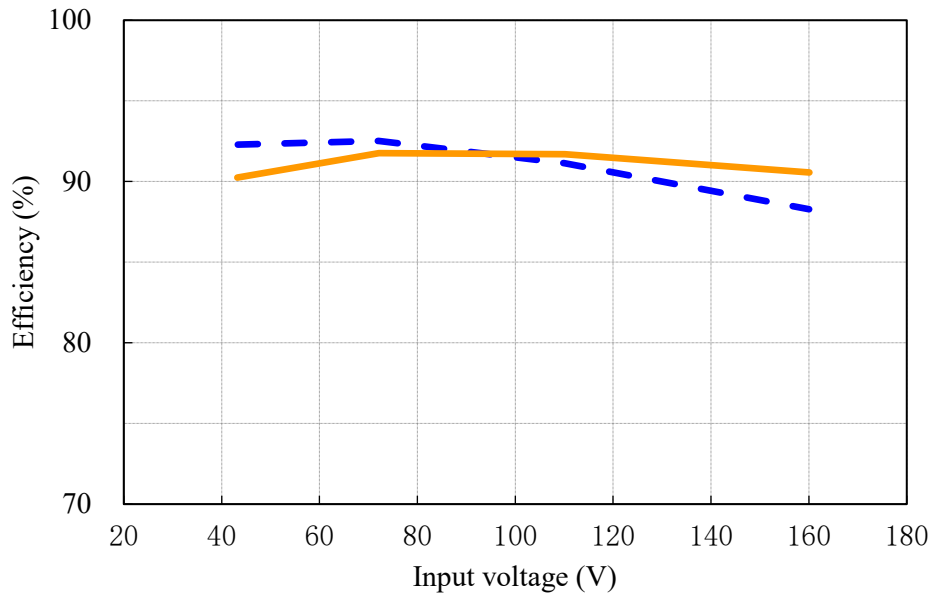

(4) 効率 対 入力電圧

Efficiency vs. Input voltage

Conditions I_o : 50 % - - - -
 : 100 % ————
 T_{bp} : 25 °C

15V

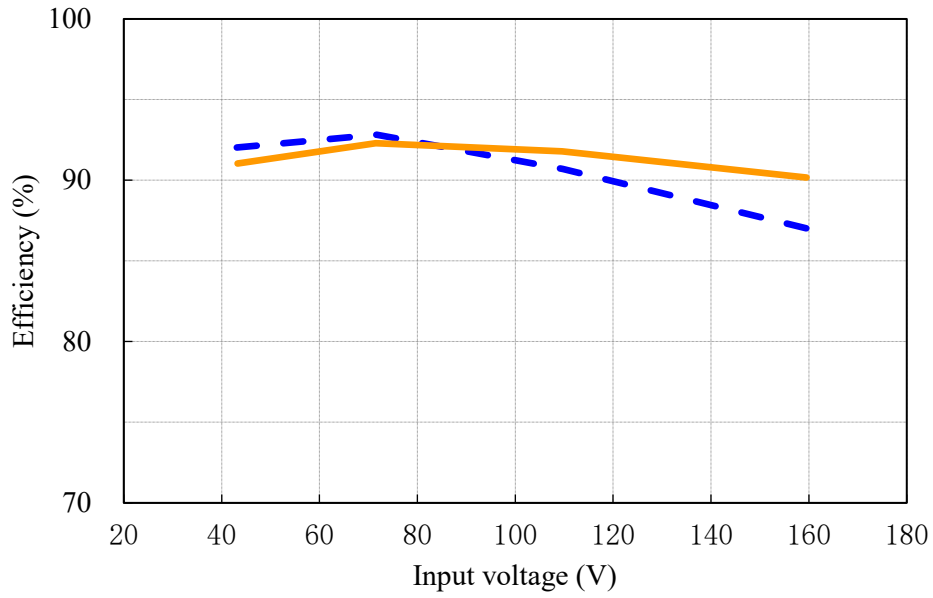

24V

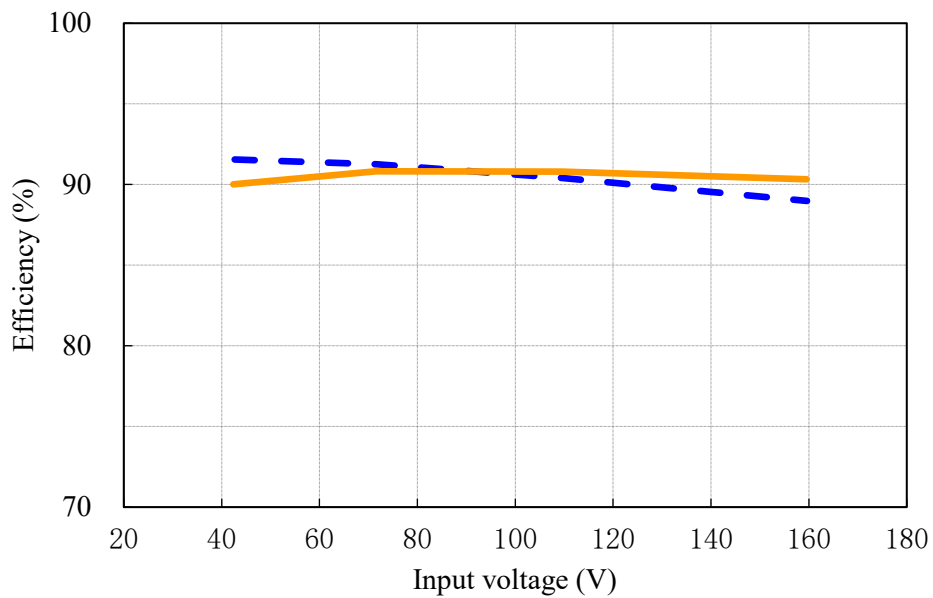

(4) 効率 対 入力電圧

Efficiency vs. Input voltage

Conditions I_o : 50 % - - - -
 : 100 % ————
 T_{bp} : 25 °C

48V

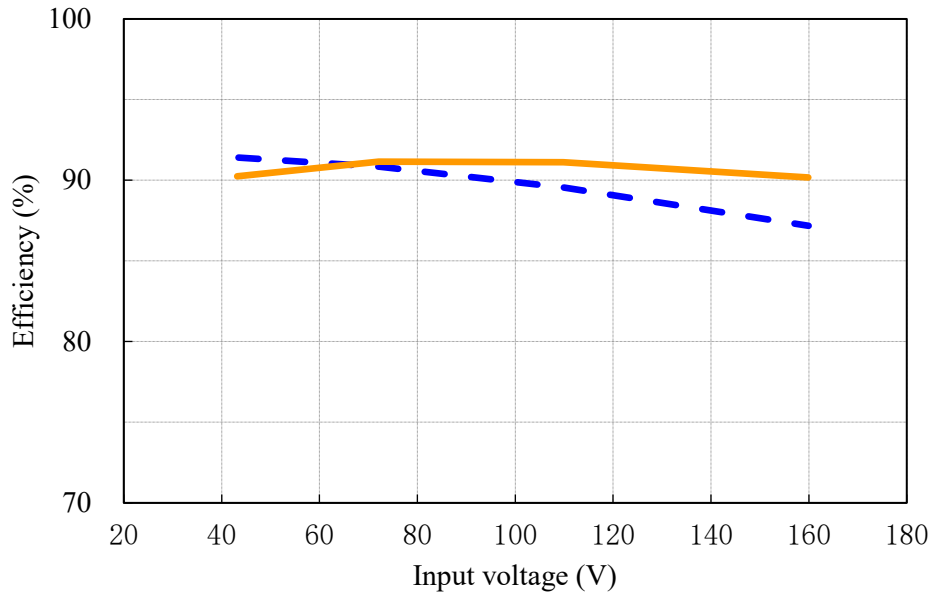

(5) 効率 対 ベースプレート温度
Efficiency vs. Base-plate temperature

Conditions Vin : 110 VDC
Io : 100 %

5V

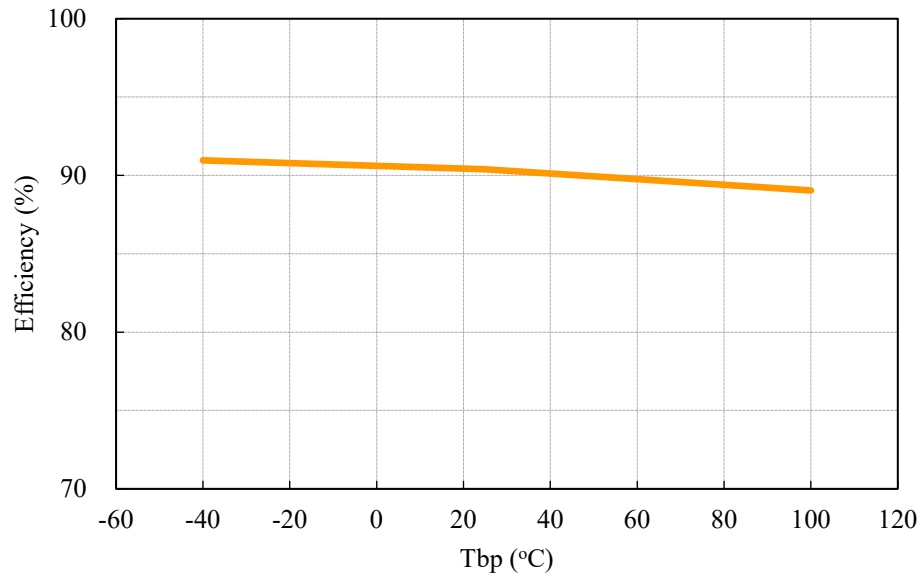

12V

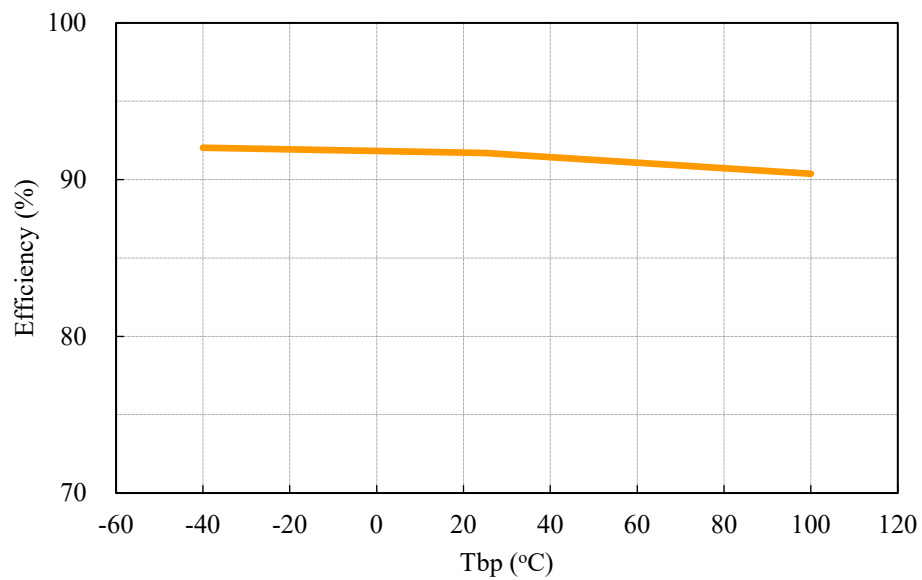

(5) 効率 対 ベースプレート温度
Efficiency vs. Base-plate temperature

Conditions Vin : 110 VDC
Io : 100 %

15V

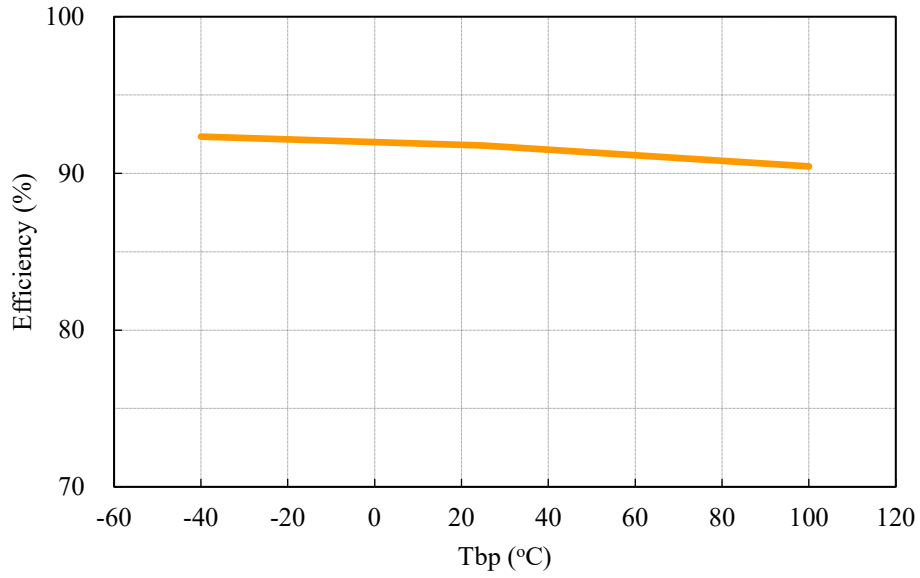

24V

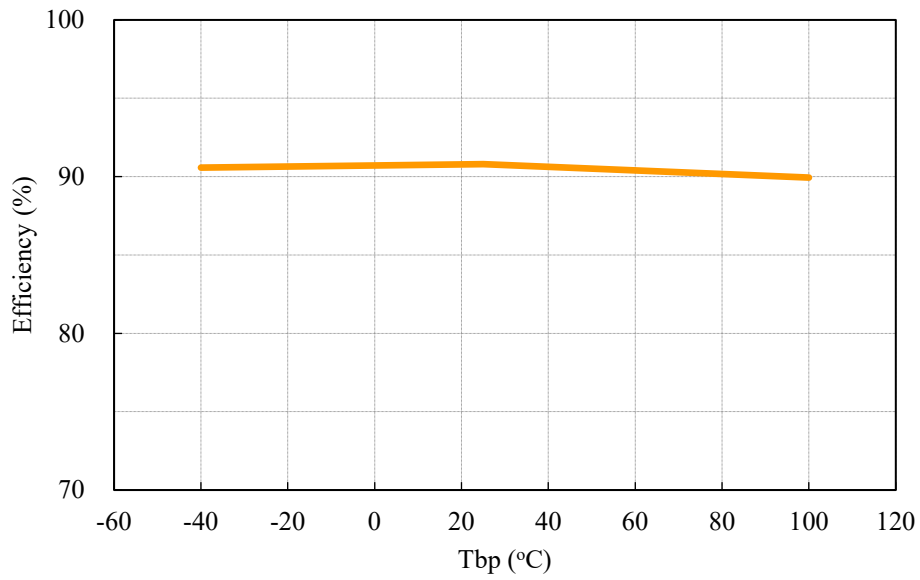

(5) 効率 対 ベースプレート温度
Efficiency vs. Base-plate temperature

Conditions Vin : 110 VDC
Io : 100 %

48V

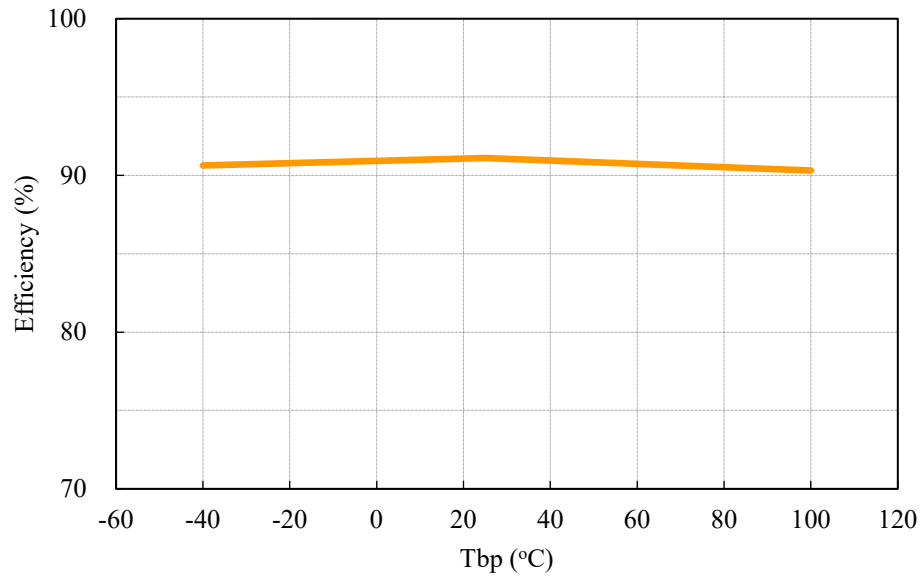

(6) 起動、停止電圧特性
Start and Stop voltage characteristics

出力電圧 対 入力電圧
Output voltage vs. Input voltage

Conditions I_o : 100 %
 T_{bp} : 25 °C

入力電流 対 入力電圧
Input current vs. Input voltage

Conditions I_o : 100 %
 T_{bp} : 25 °C

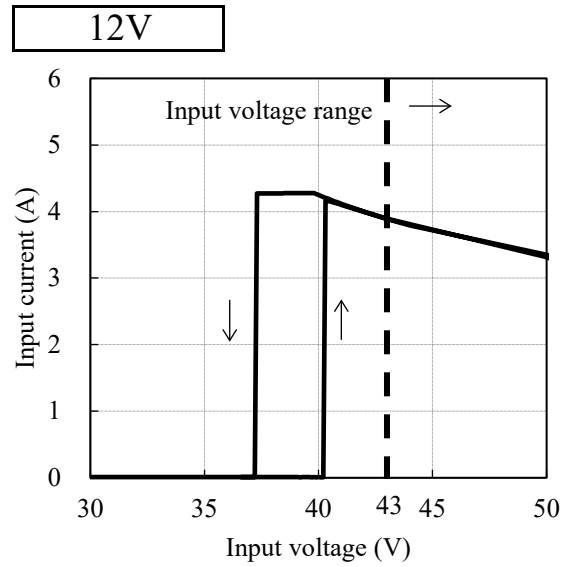
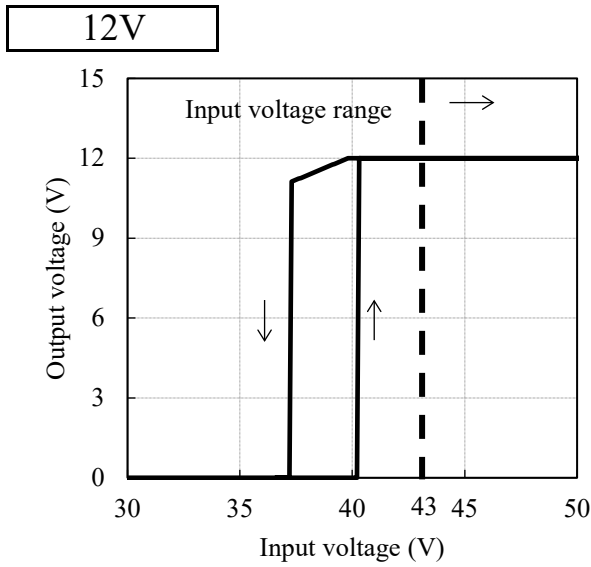
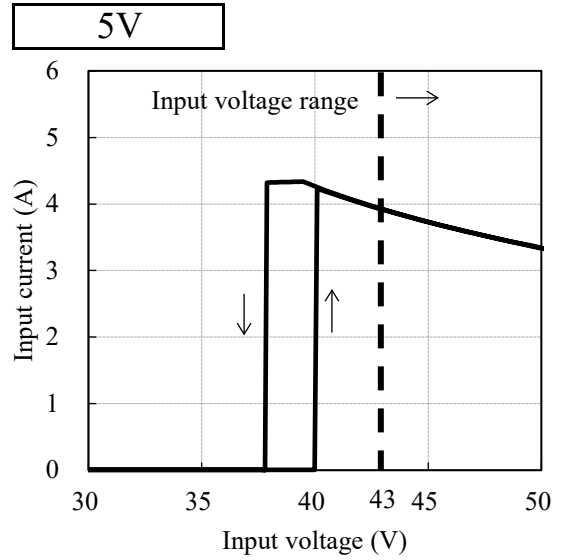
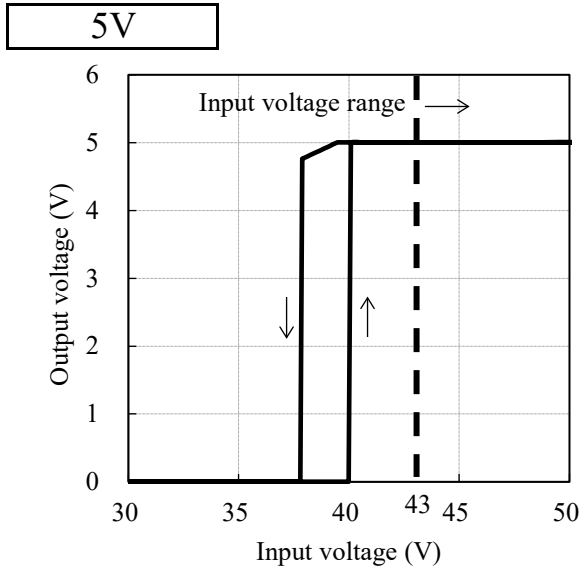

(6) 起動、停止電圧特性
Start and Stop voltage characteristics

出力電圧 対 入力電圧
Output voltage vs. Input voltage

Conditions I_o : 100 %
 T_{bp} : 25 °C

入力電流 対 入力電圧
Input current vs. Input voltage

Conditions I_o : 100 %
 T_{bp} : 25 °C

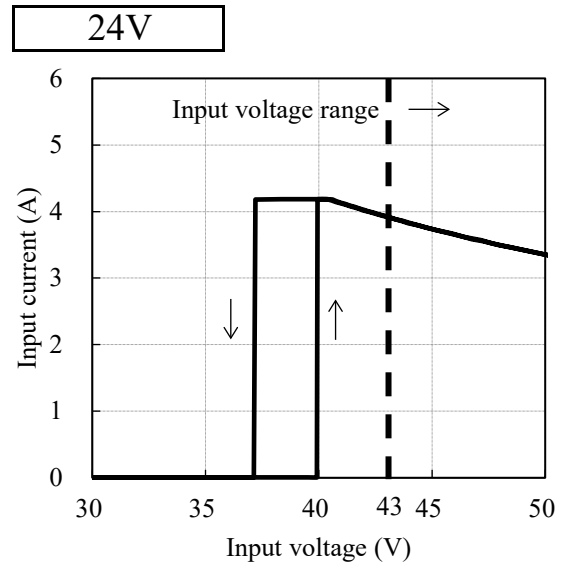
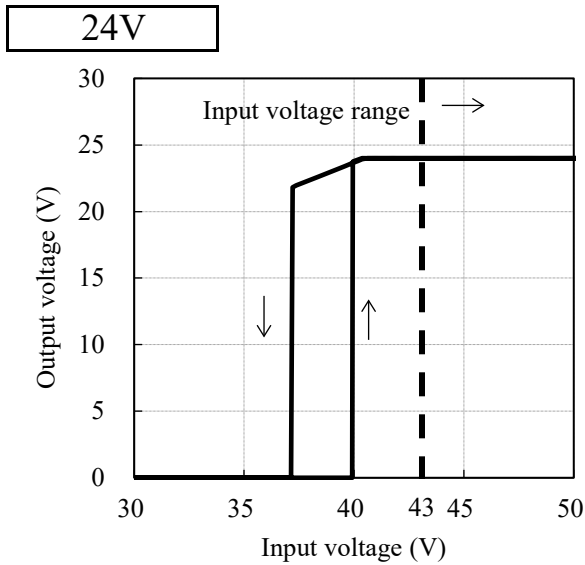
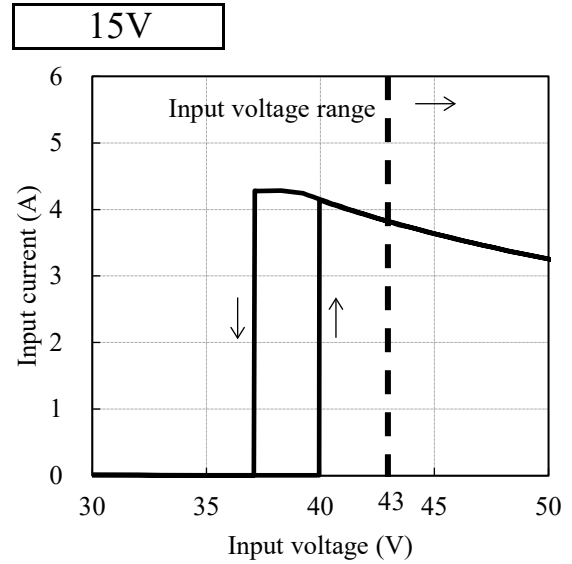
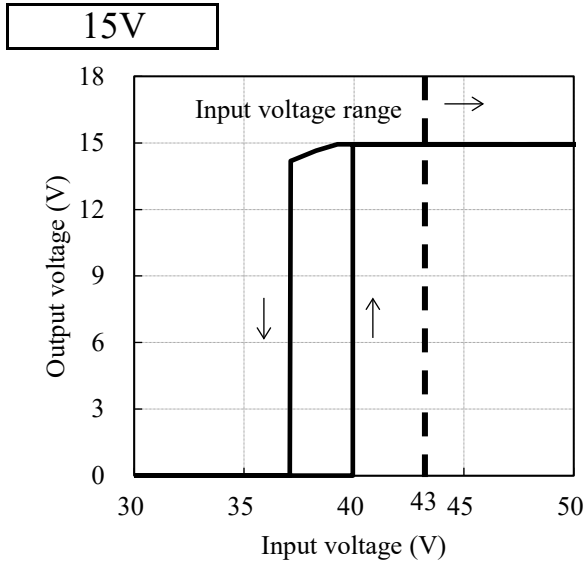

(6) 起動、停止電圧特性

Start and Stop voltage characteristics

出力電圧 対 入力電圧

Output voltage vs. Input voltage

Conditions I_o : 100 %
 T_{bp} : 25 °C

入力電流 対 入力電圧

Input current vs. Input voltage

Conditions I_o : 100 %
 T_{bp} : 25 °C

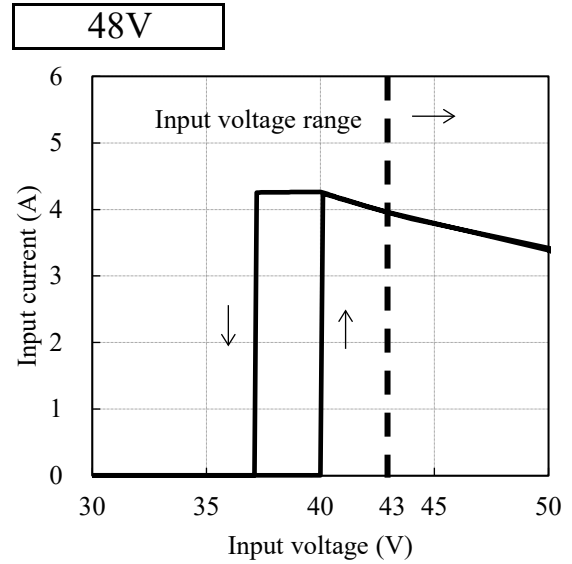
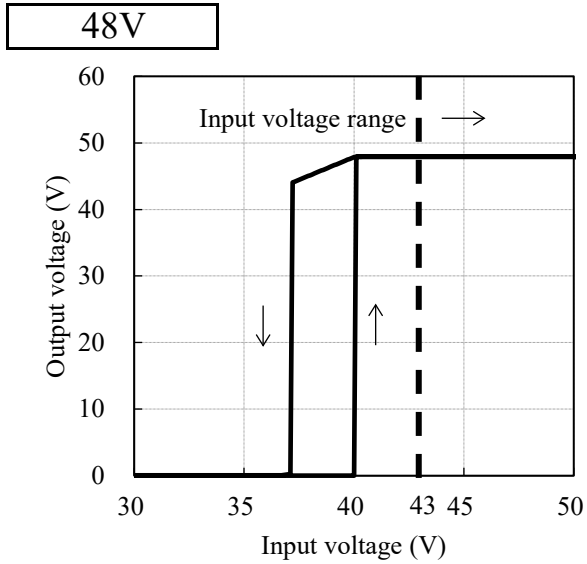

2.2 待機電力特性

Standby power characteristics

Conditions

Tbp: 25°C

5V

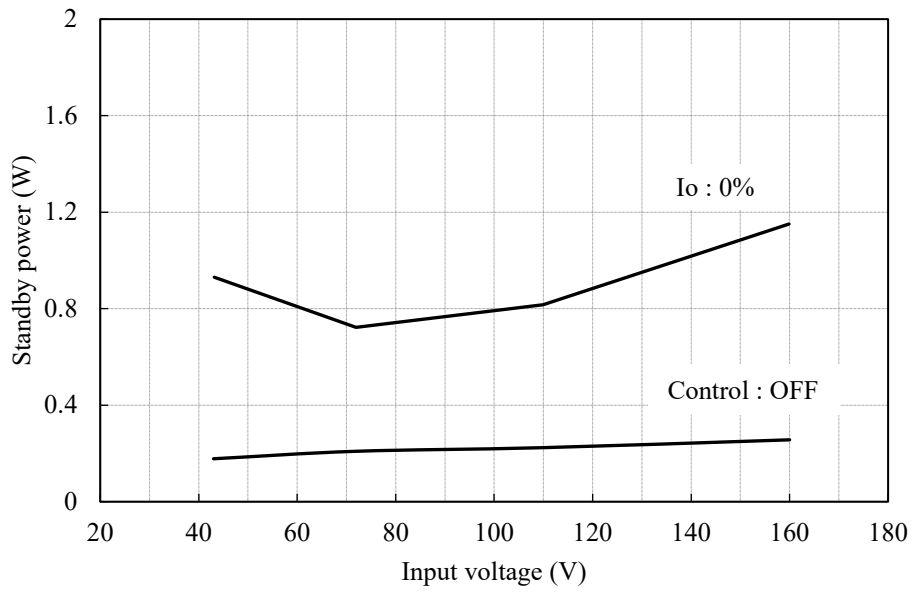

12V

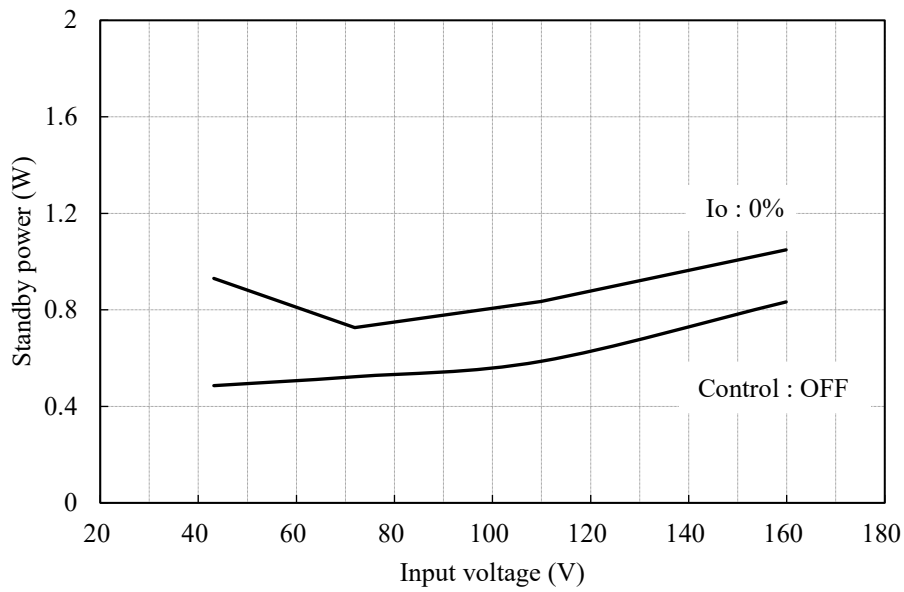

2.2 待機電力特性

Standby power characteristics

Conditions

Tbp: 25°C

15V

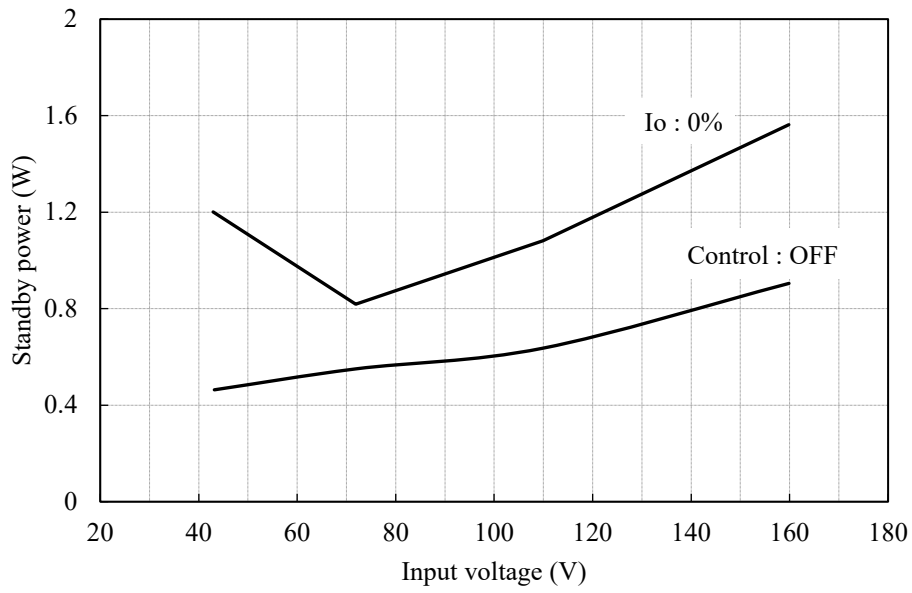

24V

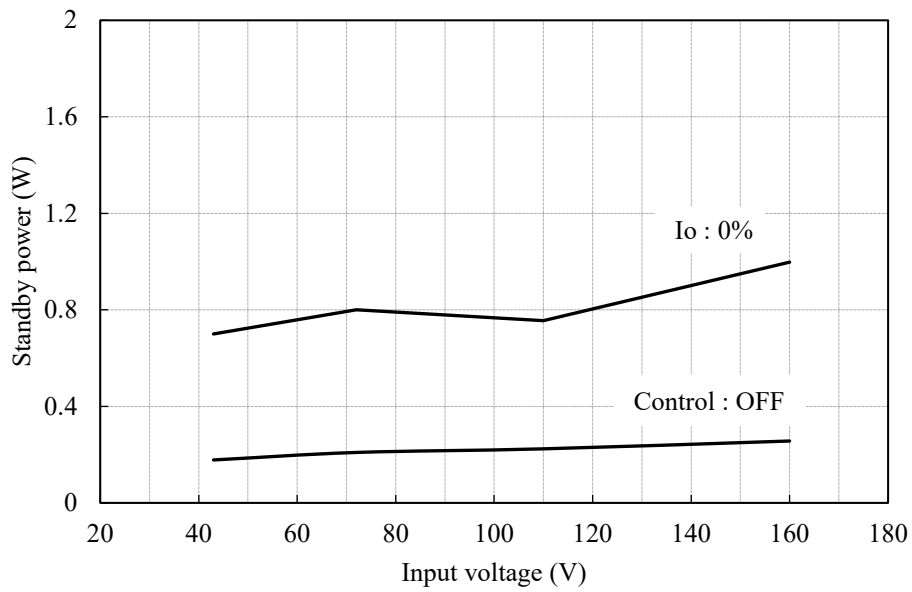

2.2 待機電力特性

Standby power characteristics

Conditions

Tbp: 25°C

48V

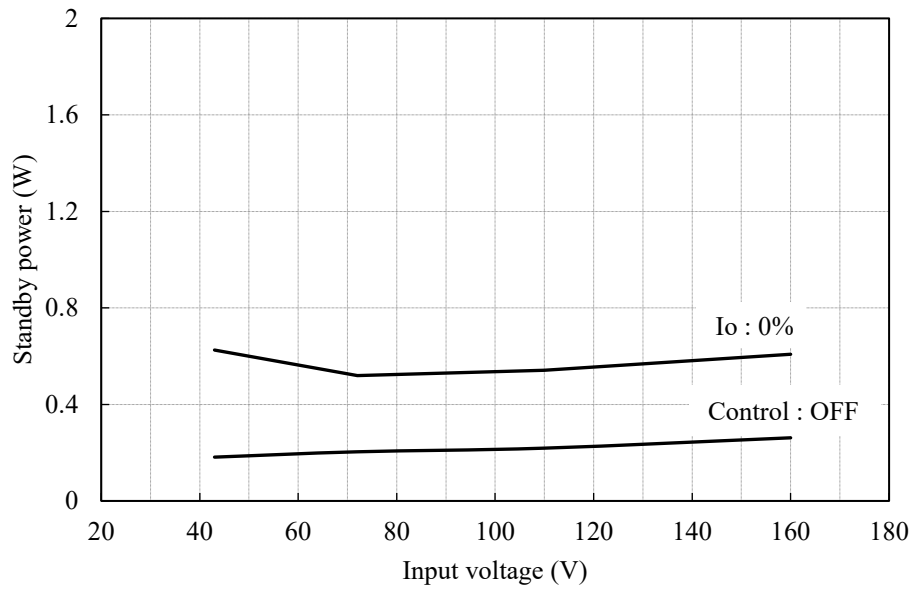

2.3 通電ドリフト特性

Warm up voltage drift characteristics

Conditions

V_{in} : 110VDC

I_o : 100%

T_a : 25°C

5V

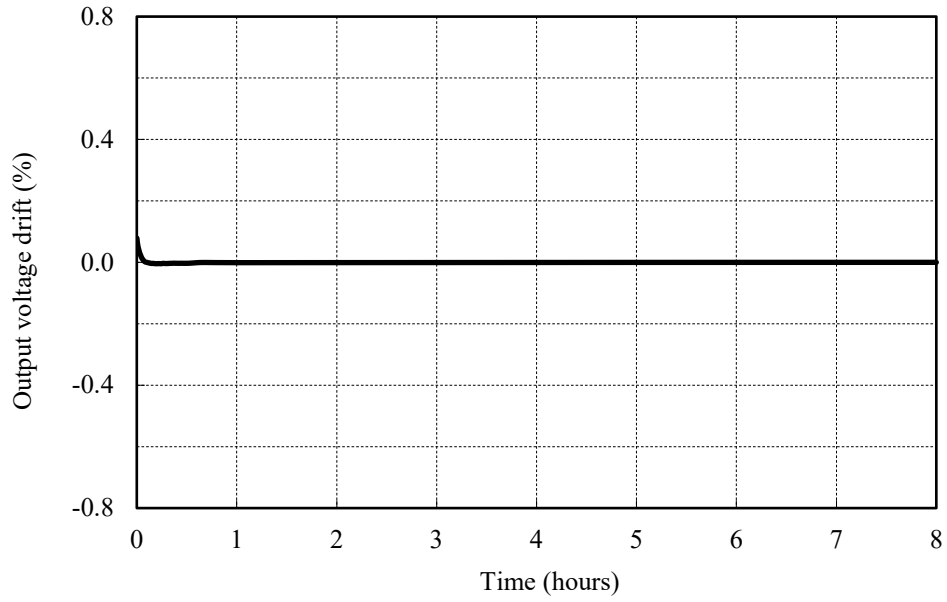

12V

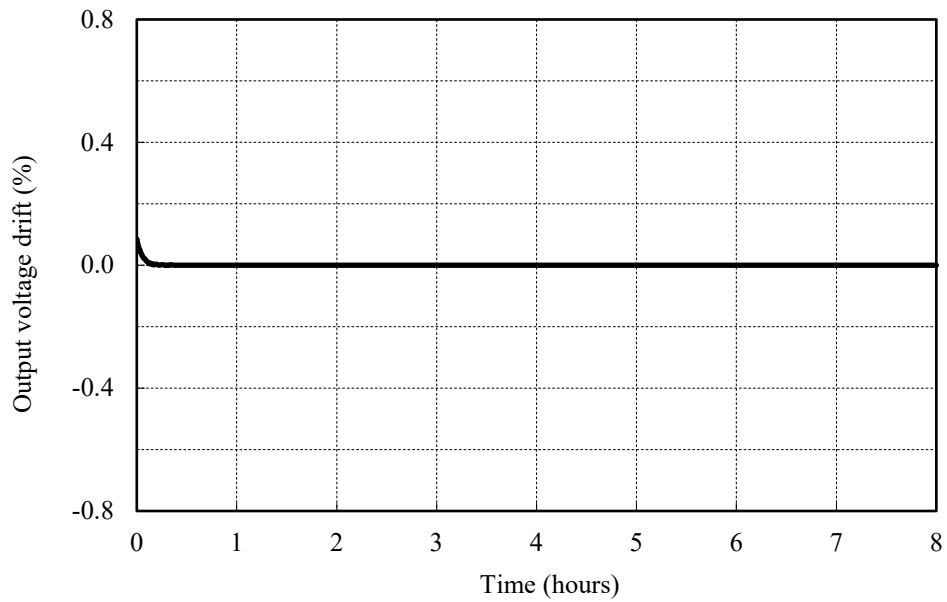

2.3 通電ドリフト特性

Warm up voltage drift characteristics

Conditions

V_{in} : 110VDC

I_o : 100%

T_a : 25°C

15V

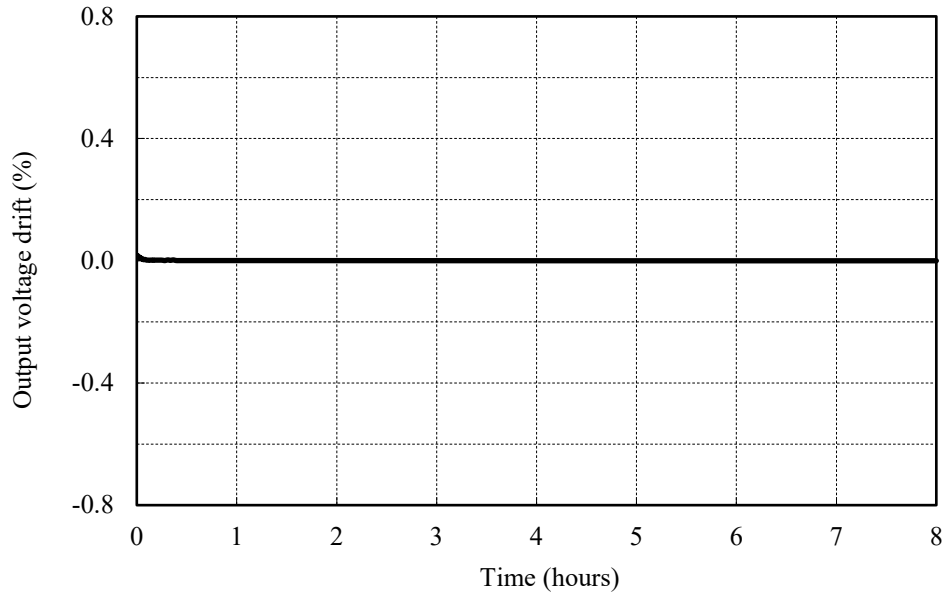

24V

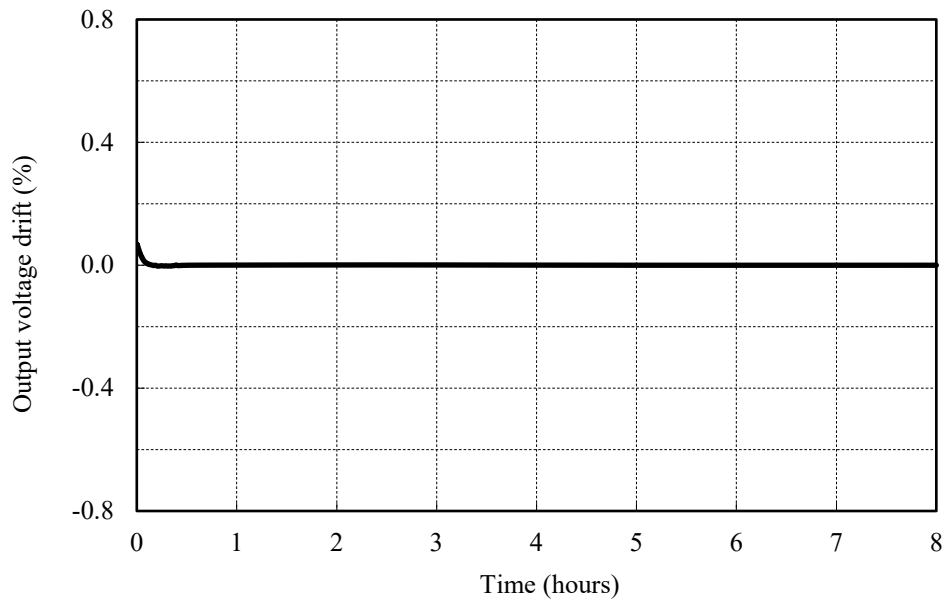

2.3 通電ドリフト特性

Warm up voltage drift characteristics

Conditions

V_{in} : 110VDC

I_o : 100%

T_a : 25°C

48V

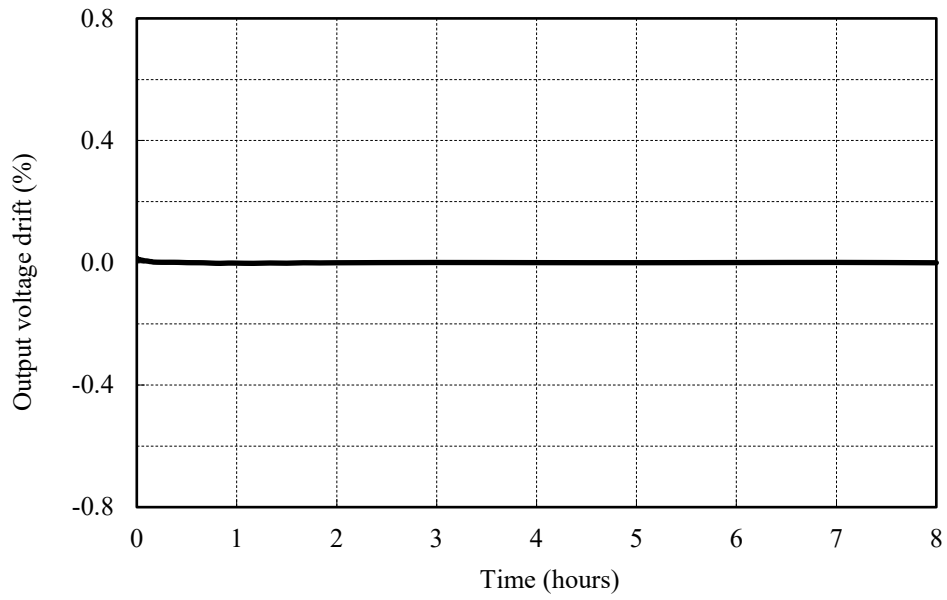

2.4 過電流保護特性

Over current protection (OCP) characteristics

入力電圧依存性

Input voltage dependence

Conditions Vin : 43 VDC ---
 : 72 VDC - - -
 : 110 VDC
 : 160 VDC - · - · -
 Tbp : 25 °C

ベースプレート温度依存性

Base-plate temperature dependence

Conditions Vin : 110 VDC
 Tbp : -40 °C ---
 : 25 °C - - -
 : 100 °C - - -

5V

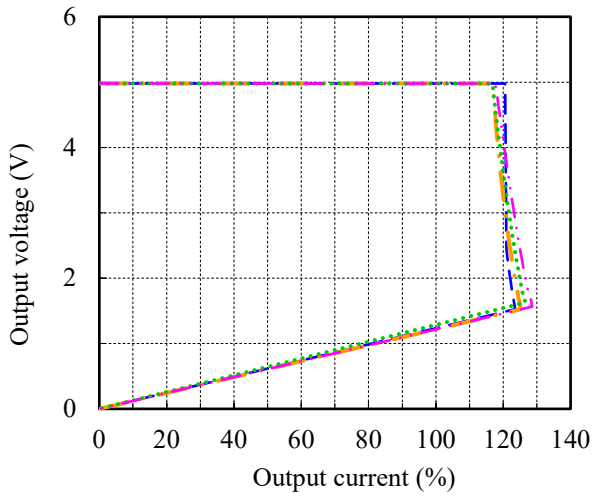

5V

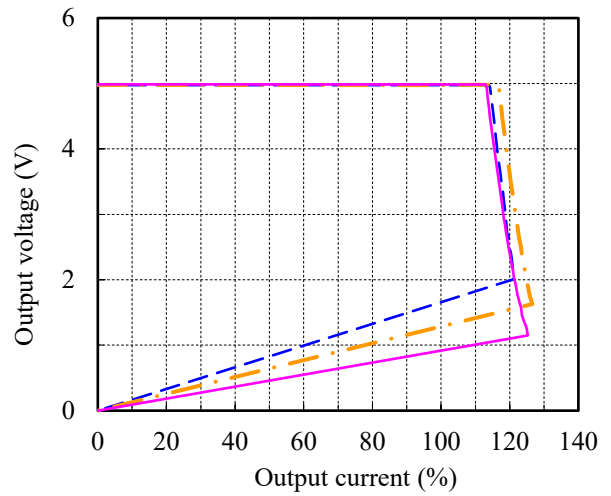

12V

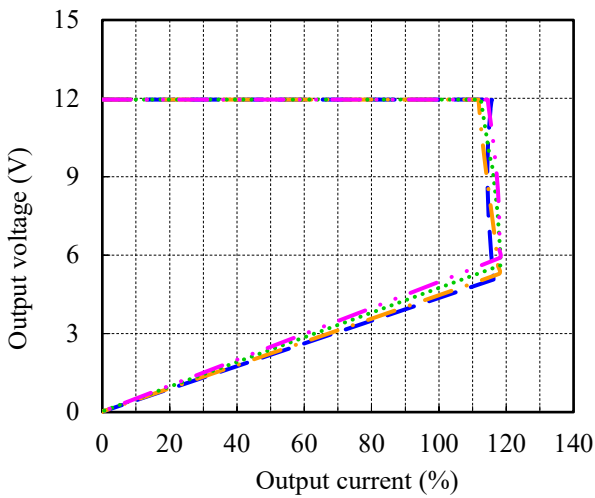

12V

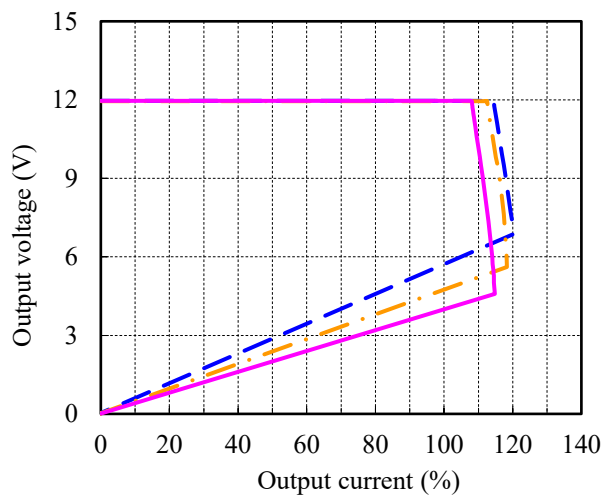

2.4 過電流保護特性

Over current protection (OCP) characteristics

入力電圧依存性

Input voltage dependence

Conditions Vin : 43 VDC ---
 : 72 VDC - - -
 : 110 VDC
 : 160 VDC - · - · -
 Tbp : 25 °C

ベースプレート温度依存性

Base-plate temperature dependence

Conditions Vin : 110 VDC
 Tbp : -40 °C ---
 : 25 °C - - -
 : 100 °C ———

15V

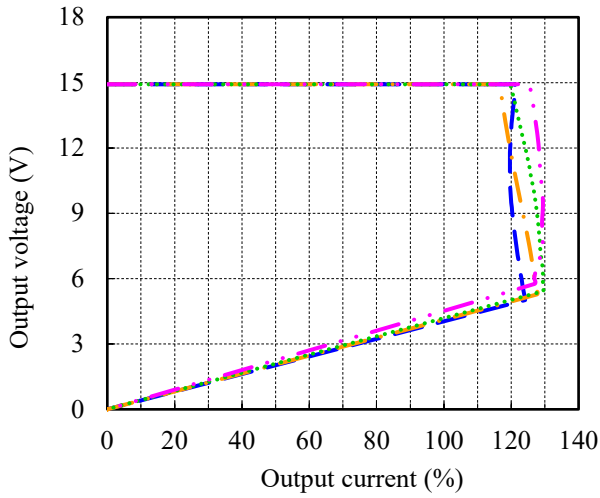

15V

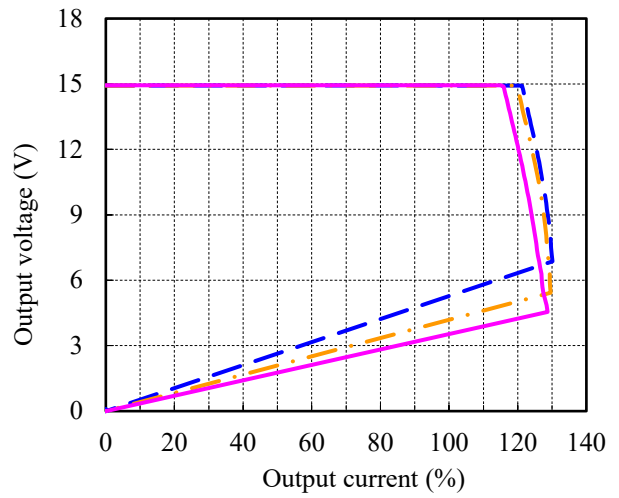

24V

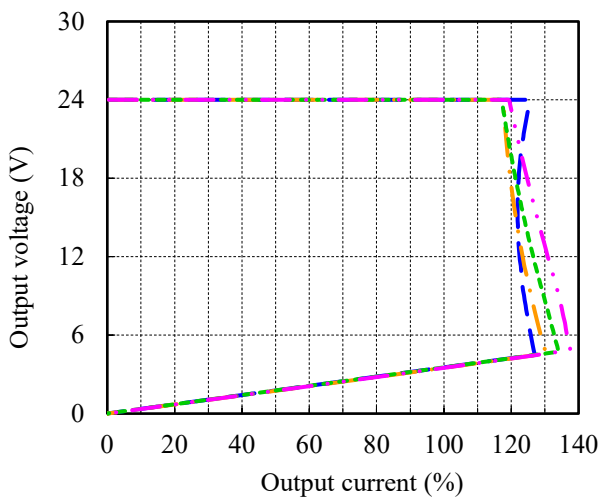

24V

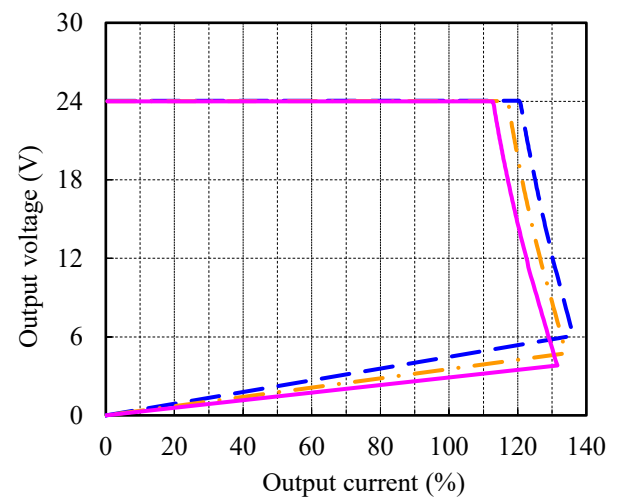

2.4 過電流保護特性

Over current protection (OCP) characteristics

入力電圧依存性

Input voltage dependence

Conditions Vin : 43 VDC ---
 : 72 VDC -.-
 : 110 VDC
 : 160 VDC -.-.-
 Tbp : 25 °C

ベースプレート温度依存性

Base-plate temperature dependence

Conditions Vin : 110 VDC
 Tbp : -40 °C ---
 : 25 °C -.-
 : 100 °C -

48V

48V

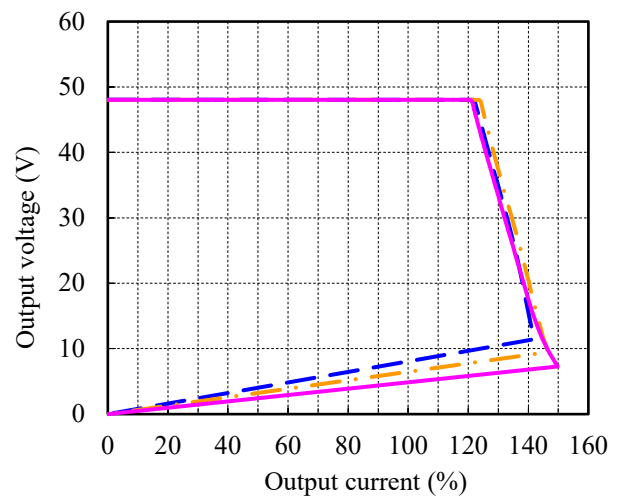
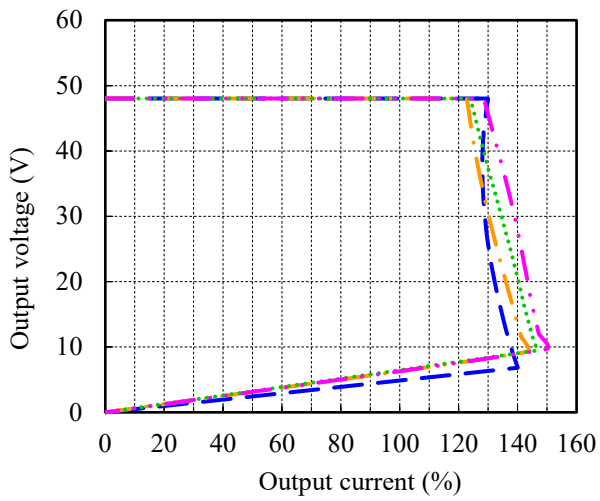

2.5 過電圧保護特性

Over voltage protection (OVP) characteristics

Conditions Vin : 110 VDC
Io : 1%
Tbp : 25 °C

5V

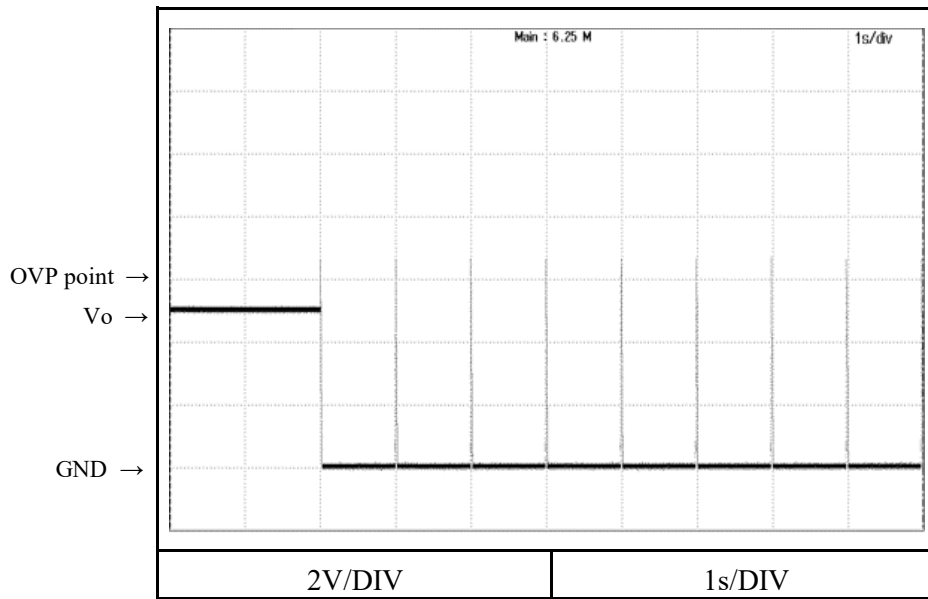

12V

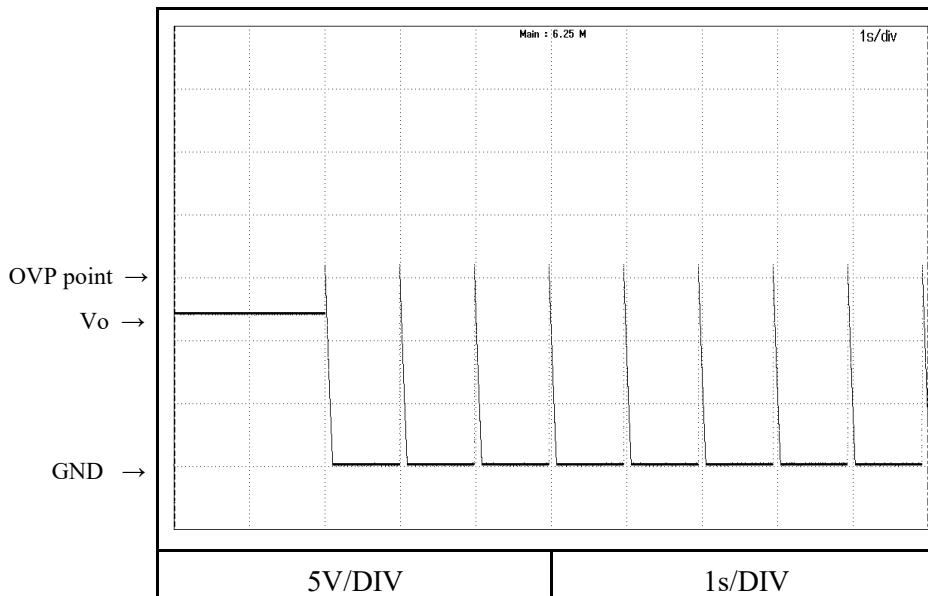

2.5 過電圧保護特性

Over voltage protection (OVP) characteristics

Conditions Vin : 110 VDC
 Io : 1%
 Tbp : 25 °C

15V

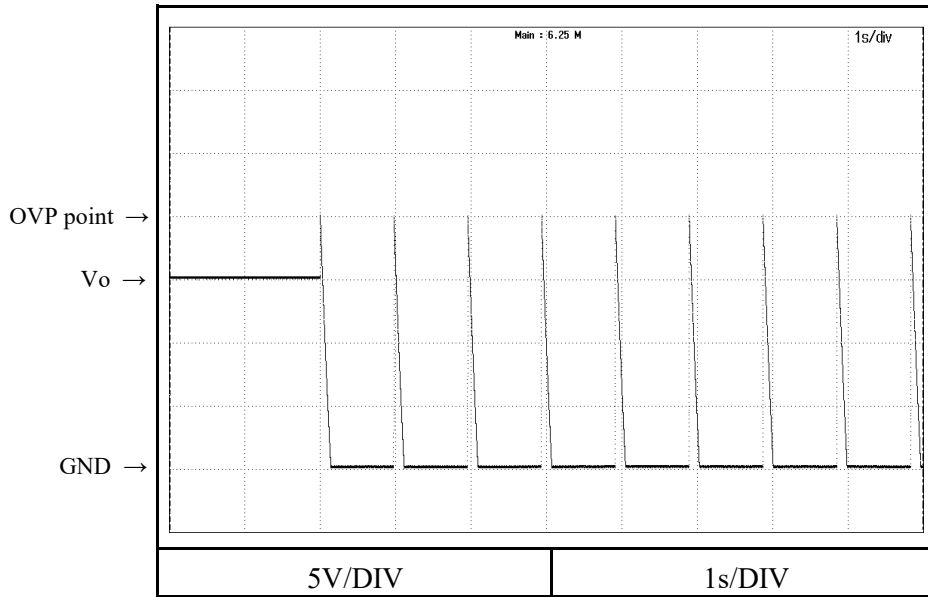

24V

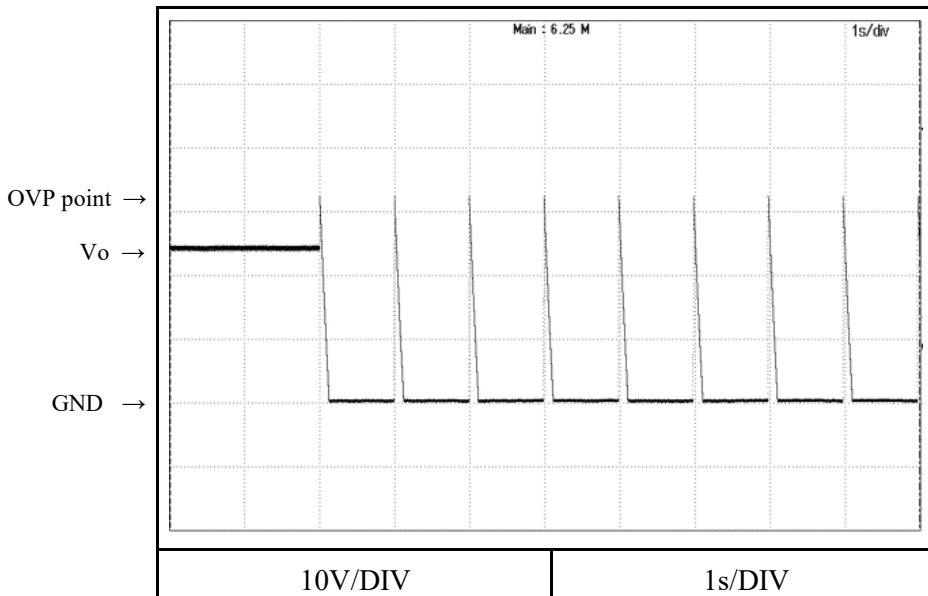

2.5 過電圧保護特性

Over voltage protection (OVP) characteristics

Conditions Vin : 110 VDC
 Io : 1%
 Tbp : 25 °C

48V

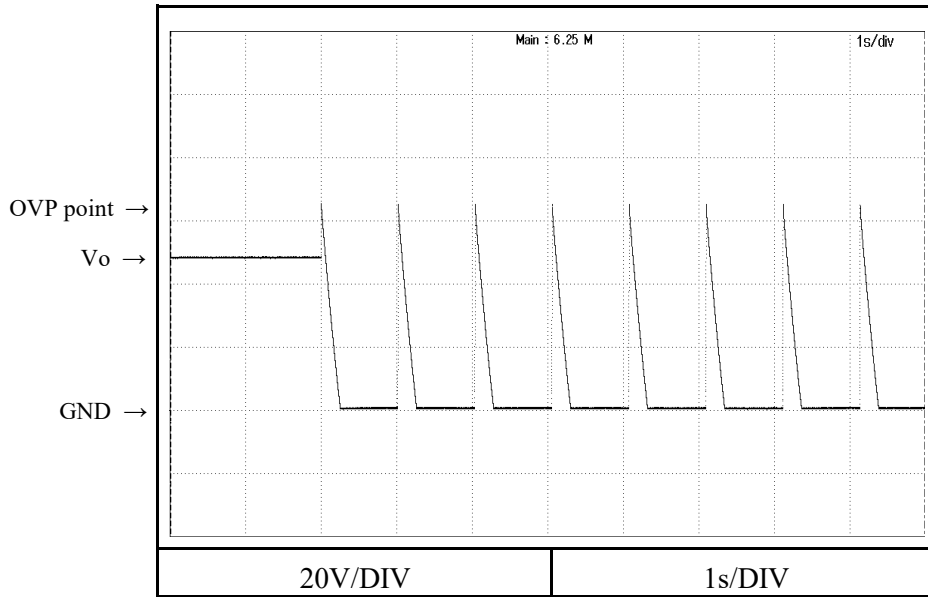

2.6 出力立ち上がり、立ち下がり特性
Output rise and fall characteristics

Conditions Vin : 110 VDC
Io : 0 %
Tbp : 25°C

5V

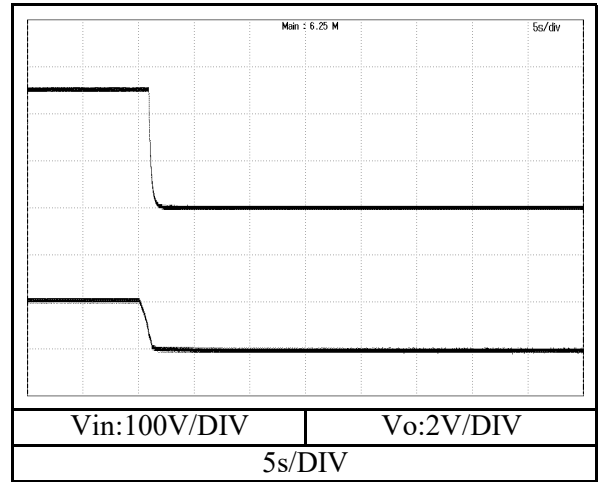
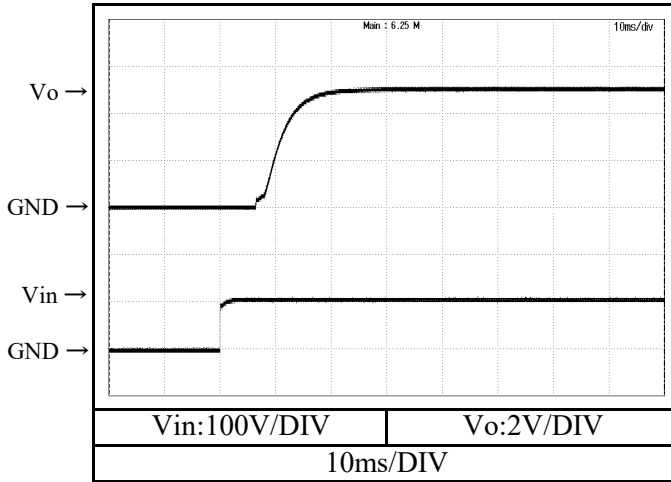

12V

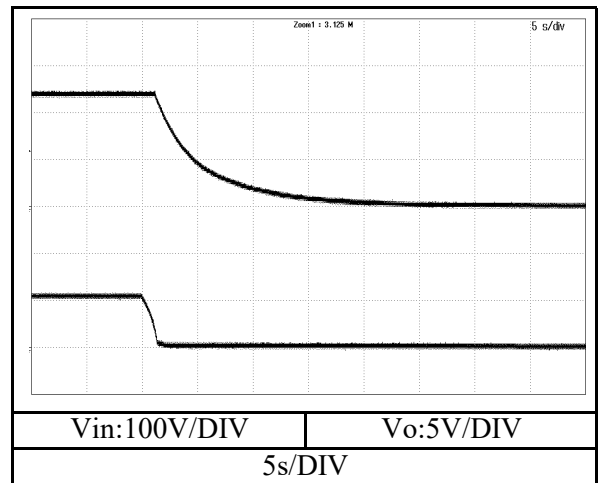
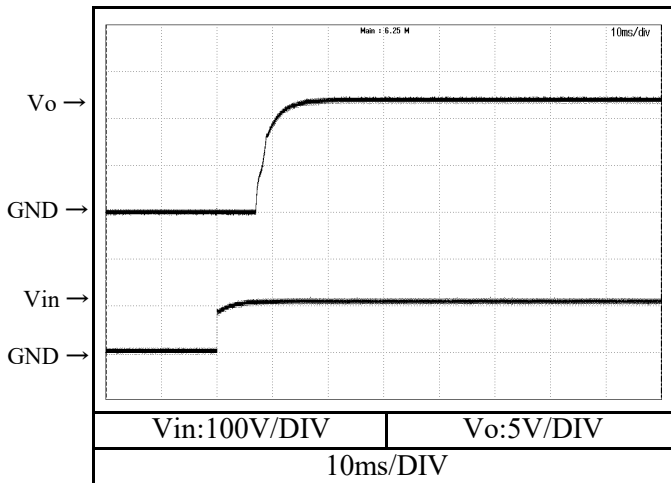

2.6 出力立ち上がり、立ち下がり特性
Output rise and fall characteristics

Conditions Vin : 110 VDC
Io : 0 %
Tbp : 25°C

15V

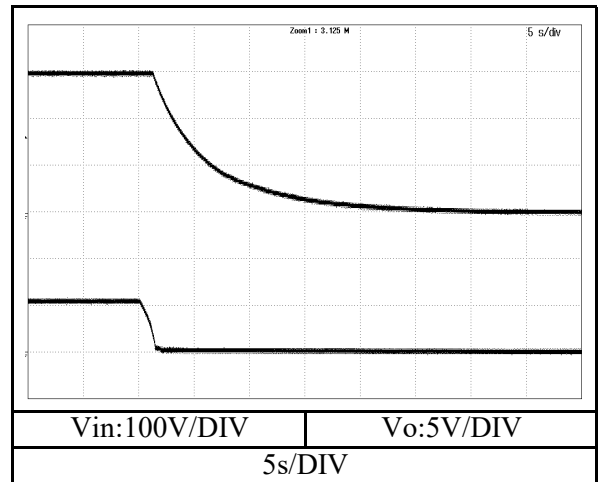
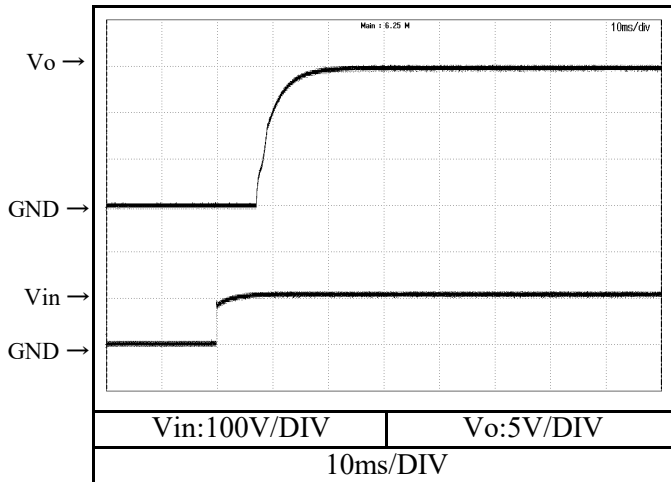

24V

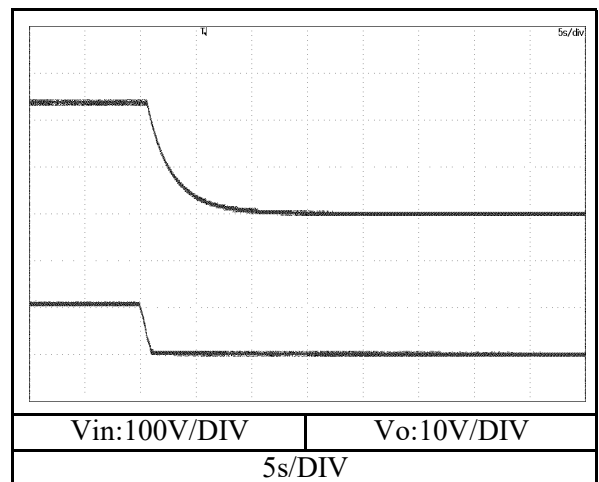
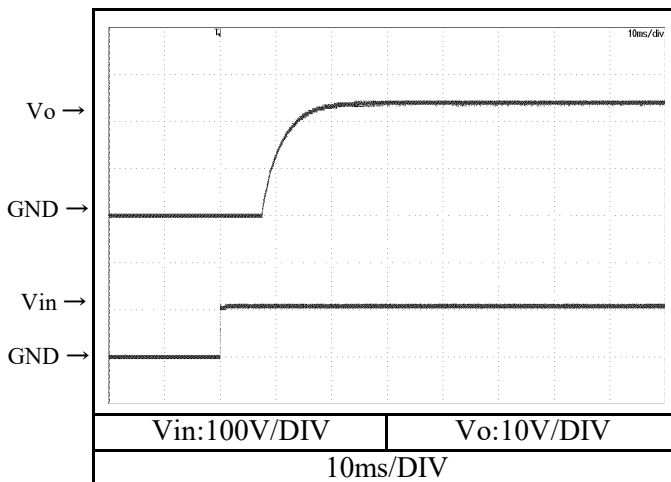

2.6 出力立ち上がり、立ち下がり特性
Output rise and fall characteristics

Conditions $V_{in} : 110 \text{ VDC}$
 $I_o : 0 \%$
 $T_{bp} : 25^\circ\text{C}$

48V

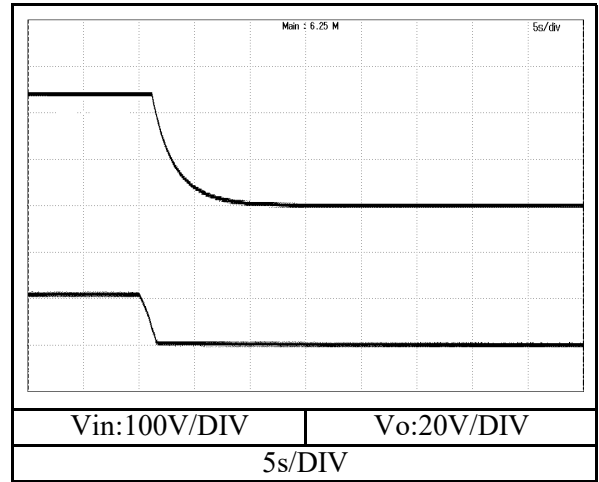
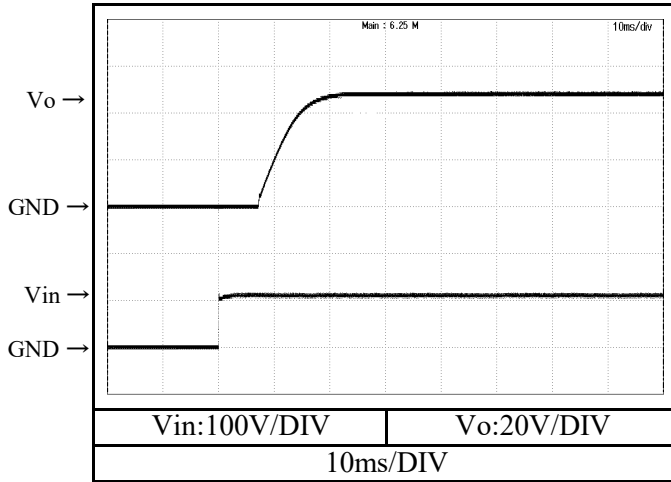

2.6 出力立ち上がり、立ち下がり特性
Output rise and fall characteristics

Conditions $V_{in} : 110 \text{ VDC}$
 $I_o : 100 \%$
 $T_{bp} : 25^\circ\text{C}$

5V

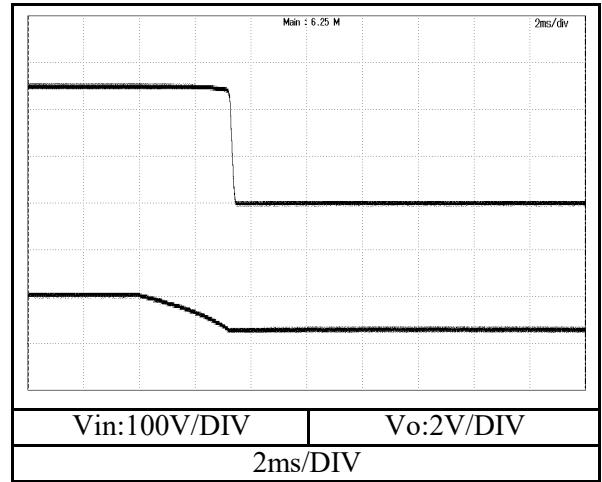
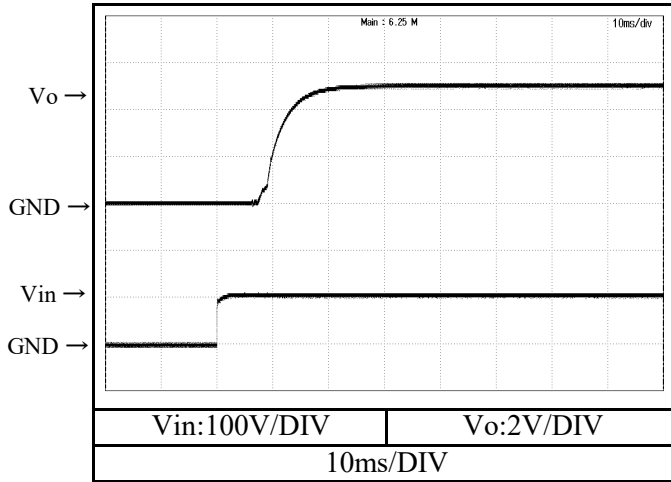

12V

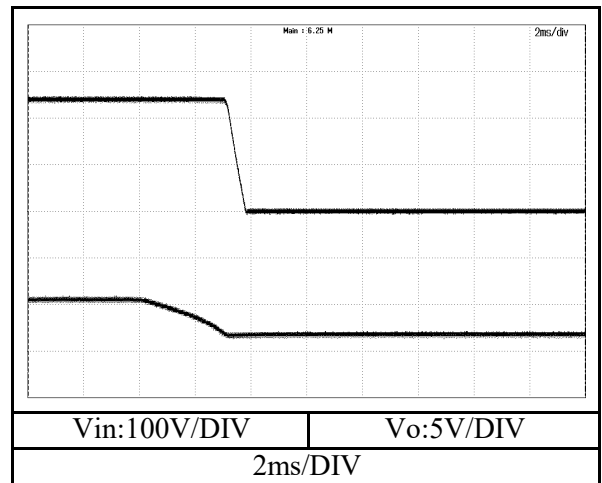
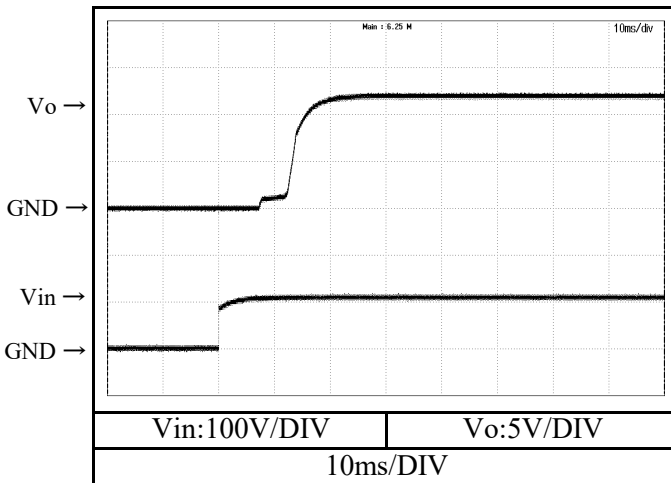

2.6 出力立ち上がり、立ち下がり特性
Output rise and fall characteristics

Conditions Vin : 110 VDC
Io : 100 %
Tbp : 25°C

15V

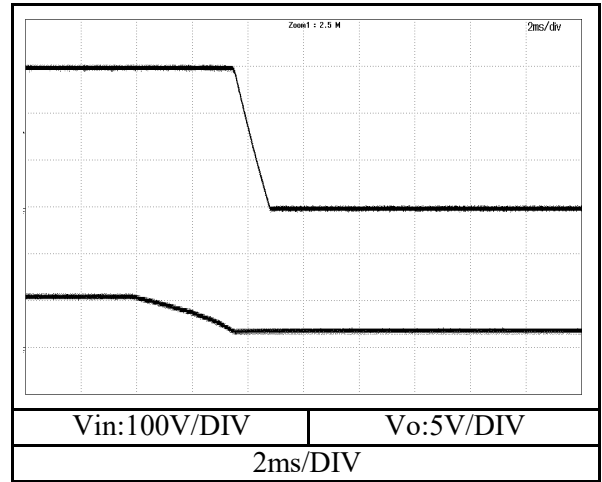
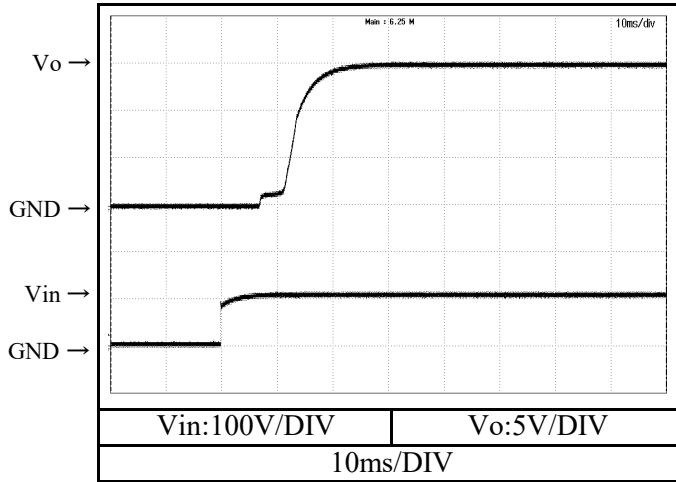

24V

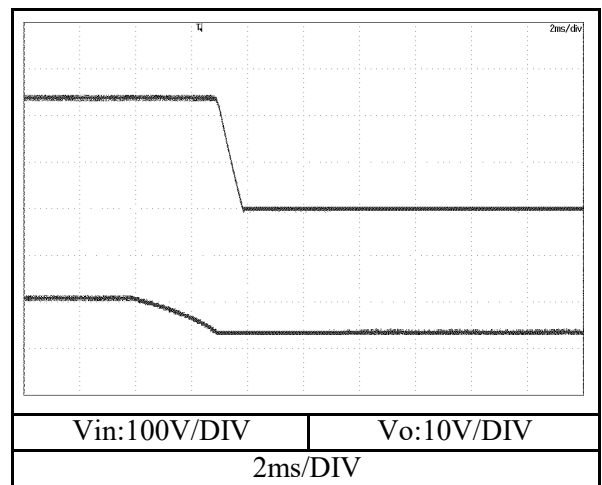
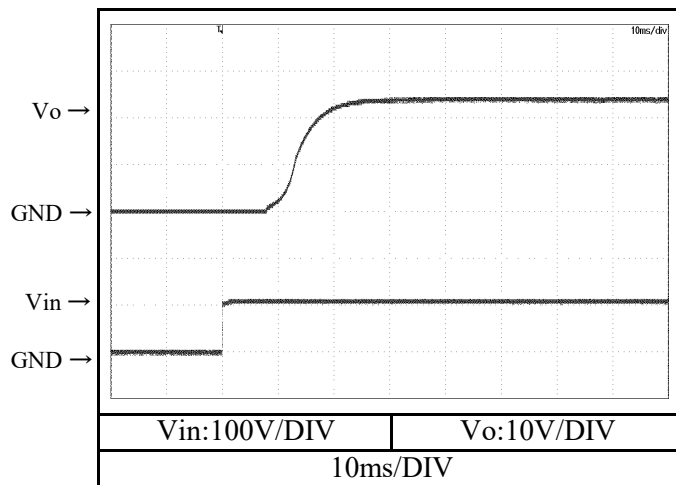

2.6 出力立ち上がり、立ち下がり特性
Output rise and fall characteristics

Conditions Vin : 110 VDC
Io : 100 %
Tbp : 25°C

48V

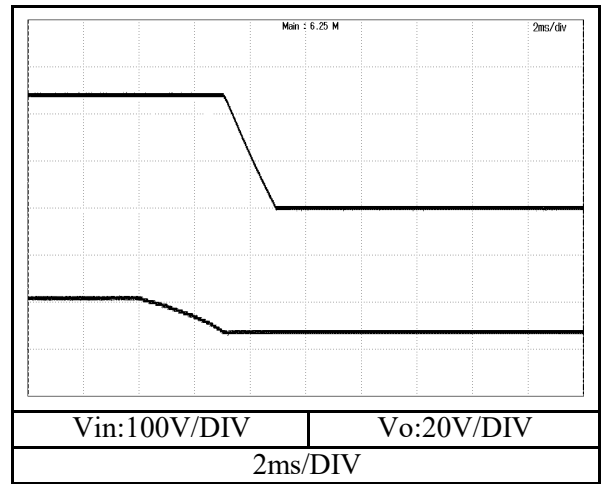
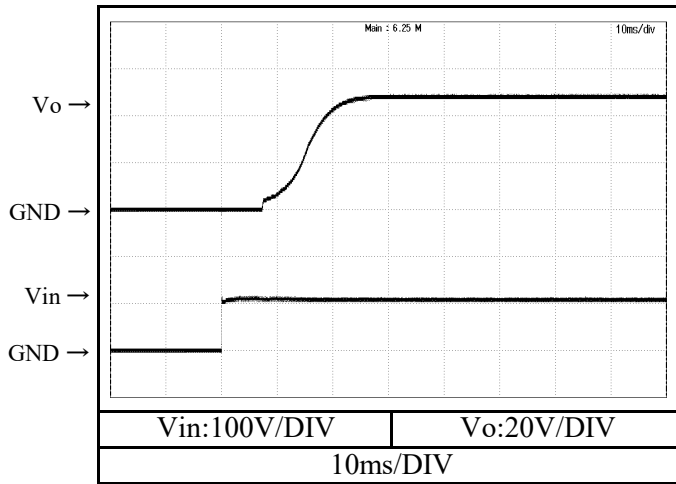

2.6 出力立ち上がり、立ち下がり特性 (ON/OFFコントロール時)

Output rise and fall characteristics with ON/OFF CONTROL

Conditions

V_{in} : 110 VDC

I_o : 0 %

T_{bp} : 25°C

5V

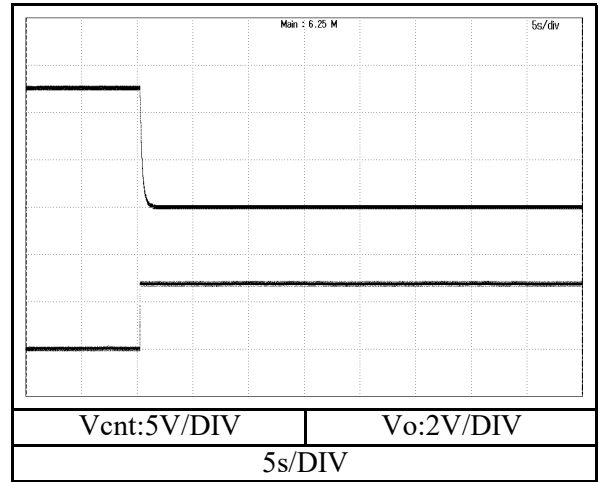
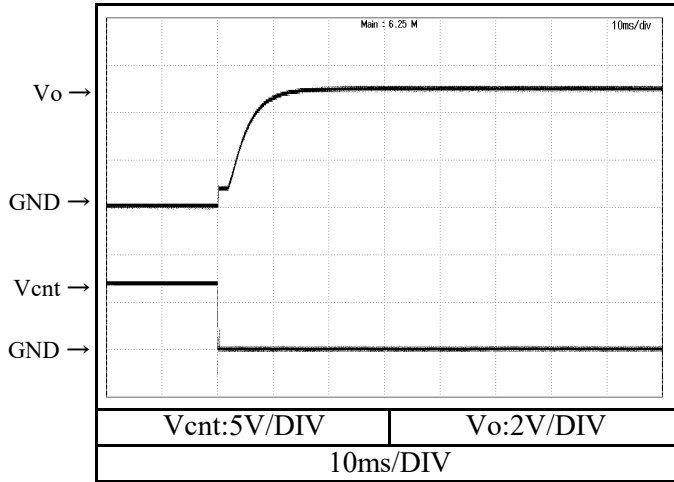

12V

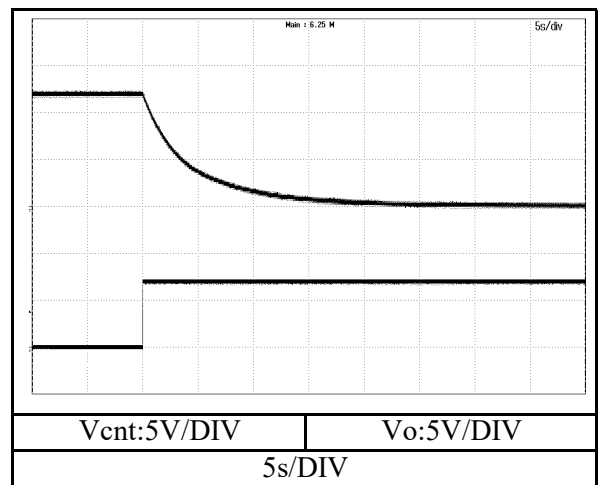
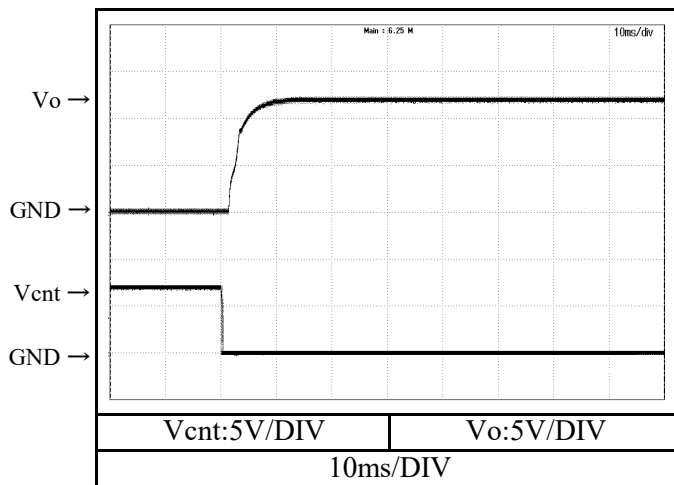

2.6 出力立ち上がり、立ち下がり特性 (ON/OFFコントロール時)

Output rise and fall characteristics with ON/OFF CONTROL

Conditions

V_{in} : 110 VDC

I_o : 0 %

T_{bp} : 25°C

15V

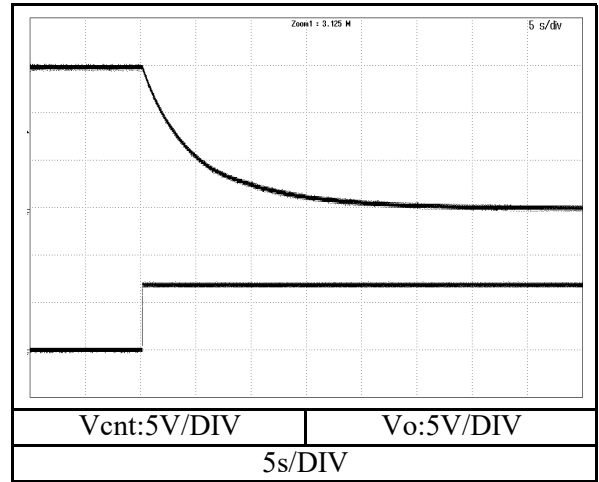
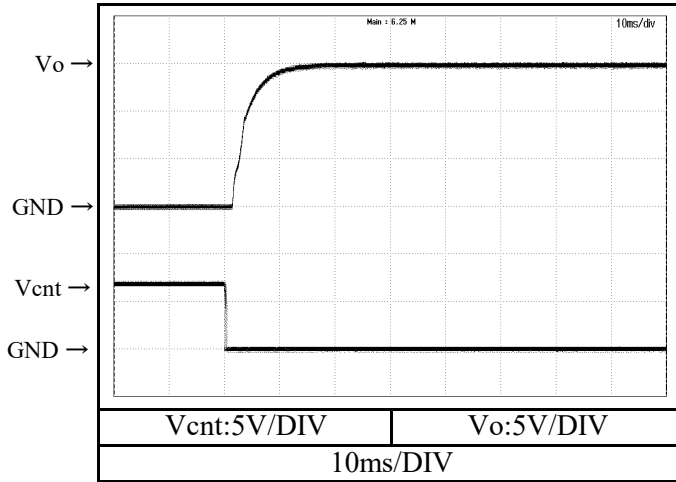

24V

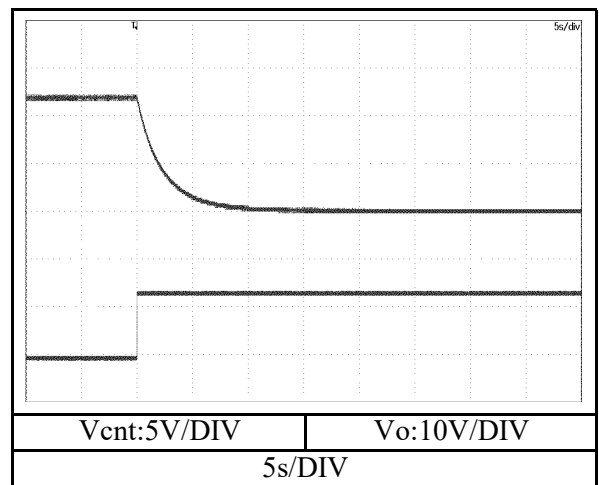
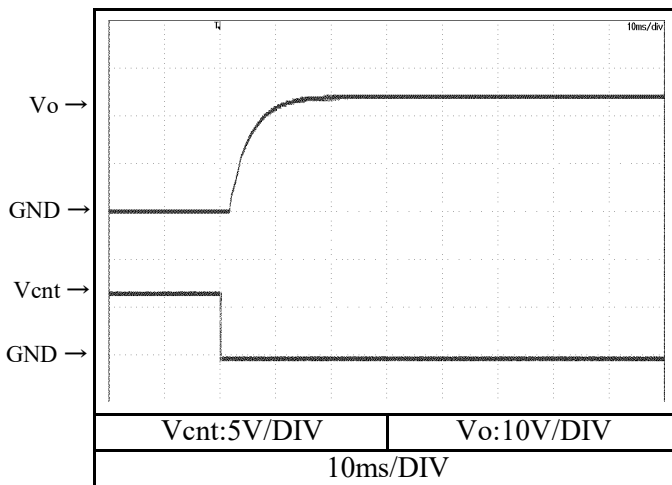

2.6 出力立ち上がり、立ち下がり特性 (ON/OFFコントロール時)

Output rise and fall characteristics with ON/OFF CONTROL

Conditions

V_{in} : 110 VDC

I_o : 0 %

T_{bp} : 25°C

48V

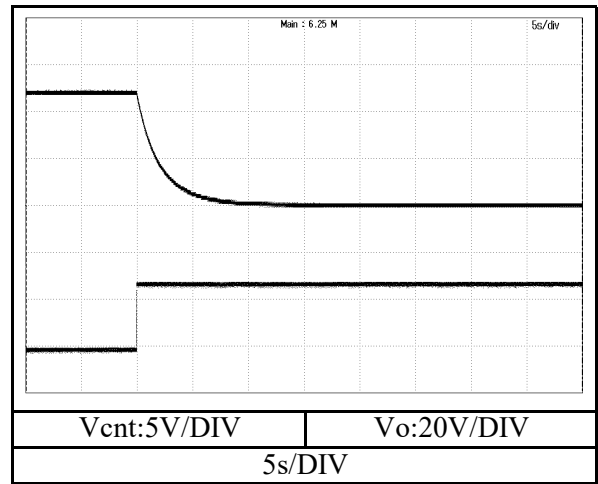
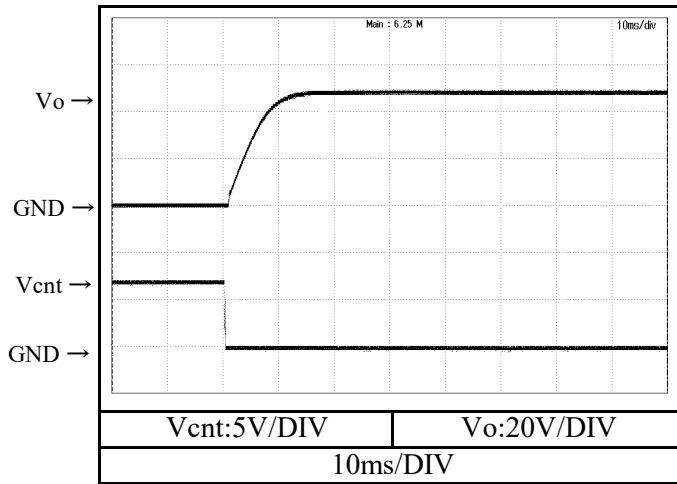

2.6 出力立ち上がり、立ち下がり特性 (ON/OFFコントロール時)

Output rise and fall characteristics with ON/OFF CONTROL

Conditions

V_{in} : 110 VDC

I_o : 100 %

T_{bp} : 25°C

5V

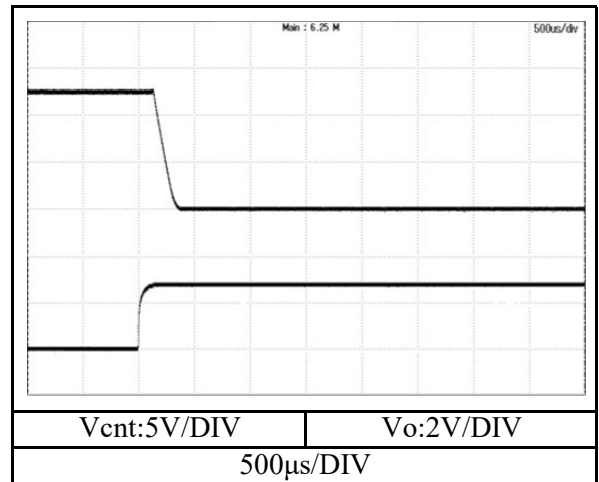
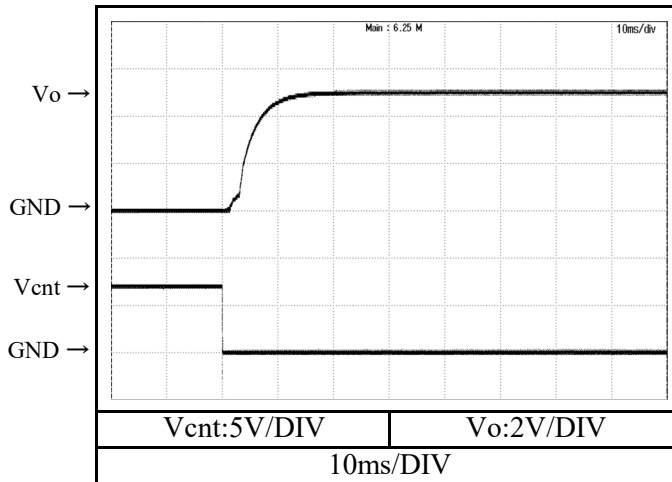

12V

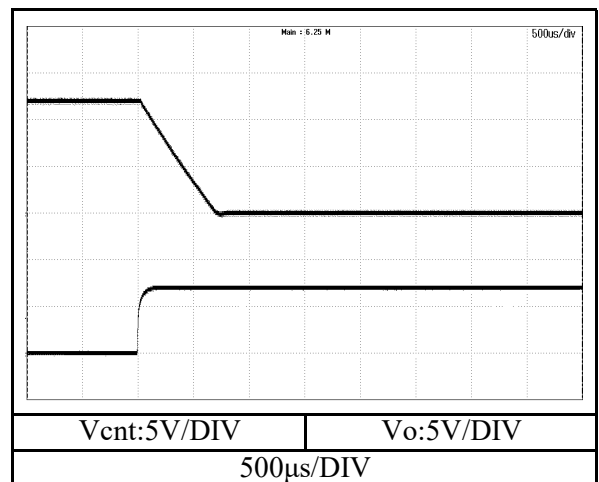
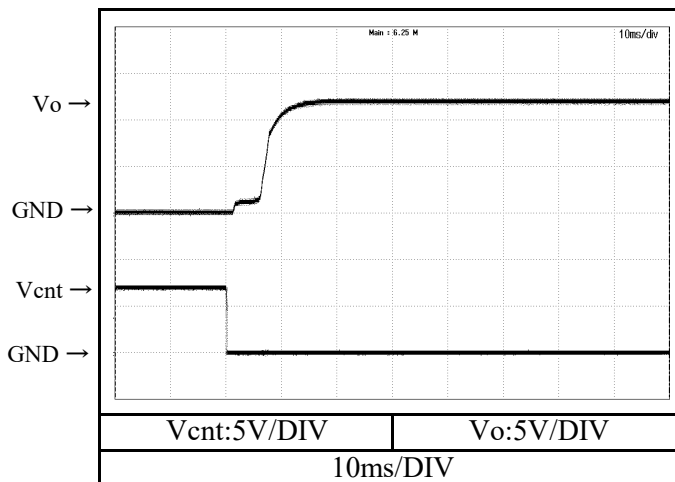

2.6 出力立ち上がり、立ち下がり特性 (ON/OFFコントロール時)

Output rise and fall characteristics with ON/OFF CONTROL

Conditions

Vin : 110 VDC

Io : 100 %

Tbp : 25°C

15V

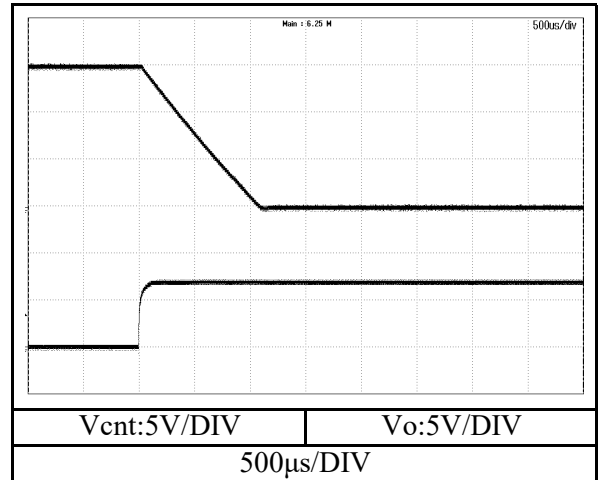
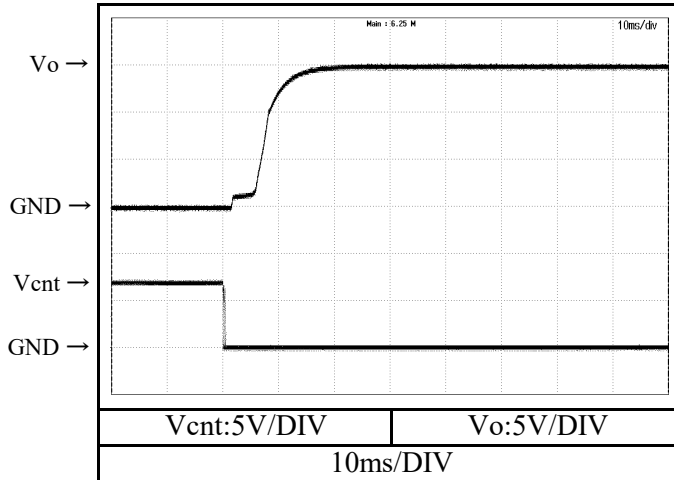

24V

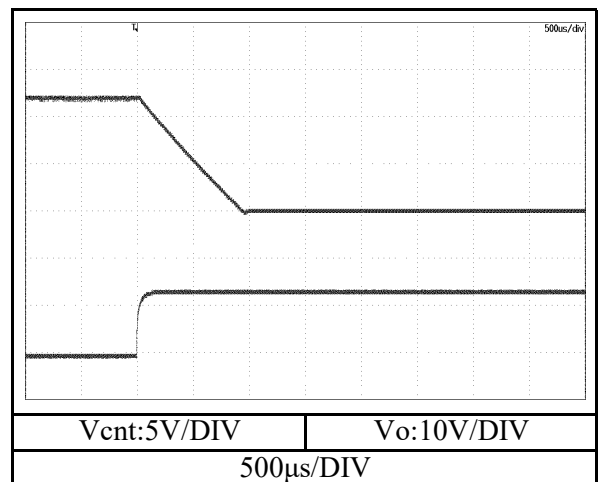
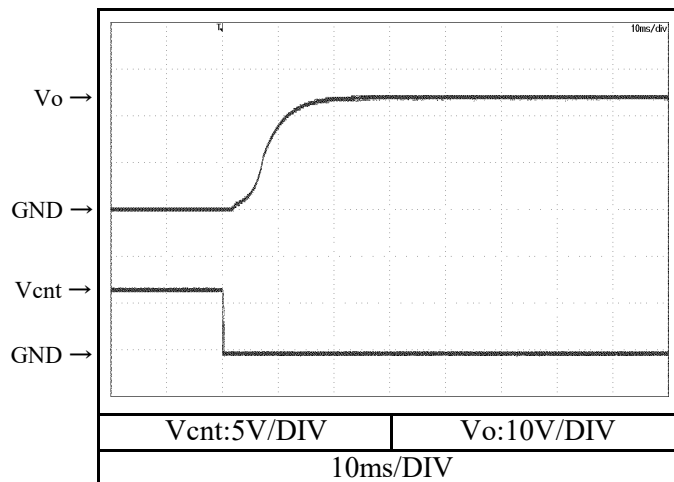

2.6 出力立ち上がり、立ち下がり特性 (ON/OFFコントロール時)

Output rise and fall characteristics with ON/OFF CONTROL

Conditions

Vin : 110 VDC

Io : 100 %

Tbp : 25°C

48V

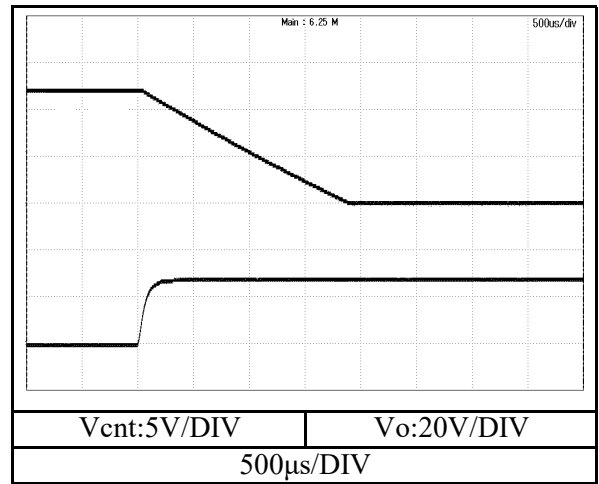
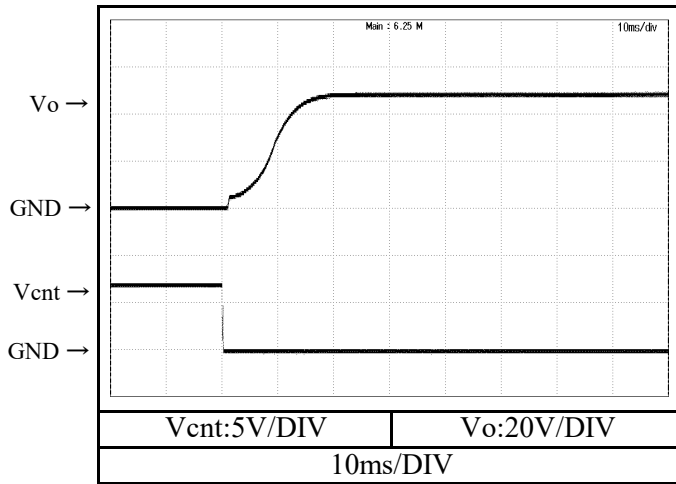

2.7 過渡応答(負荷急変)特性

Dynamic load response characteristics

Conditions

V_{in} : 110VDC

T_{bp} : 25°C

5V

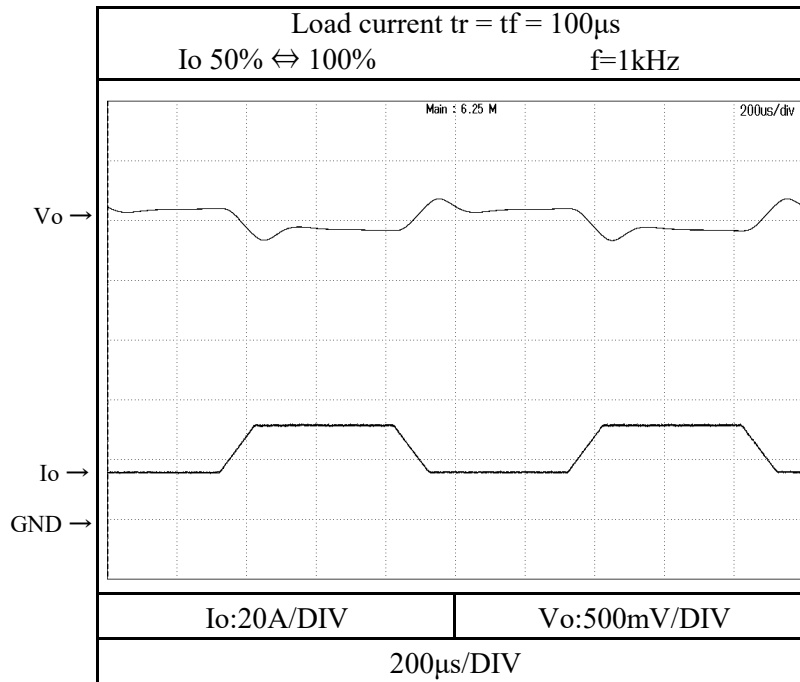

12V

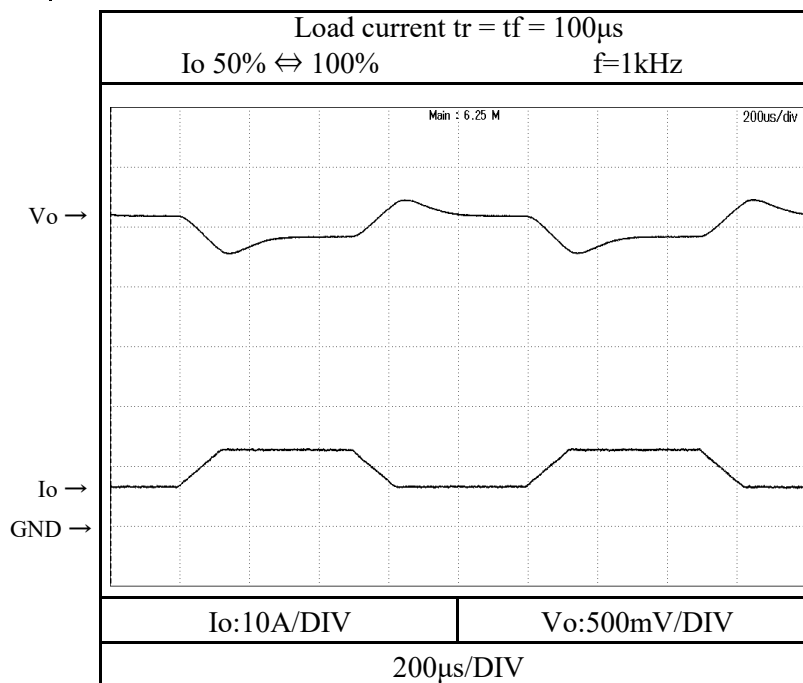

2.7 過渡応答(負荷急変)特性

Dynamic load response characteristics

Conditions

Vin : 110VDC

Tbp : 25°C

15V

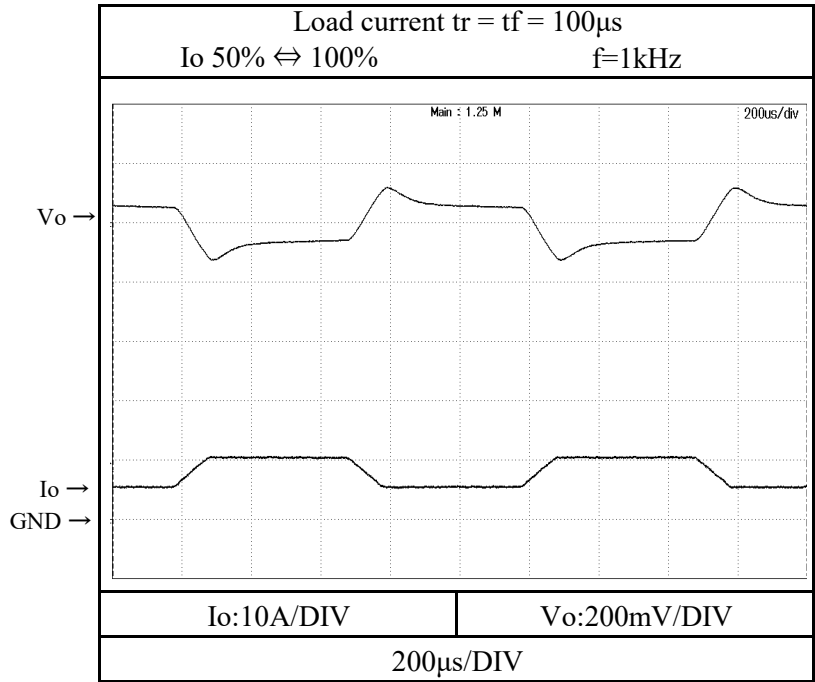

24V

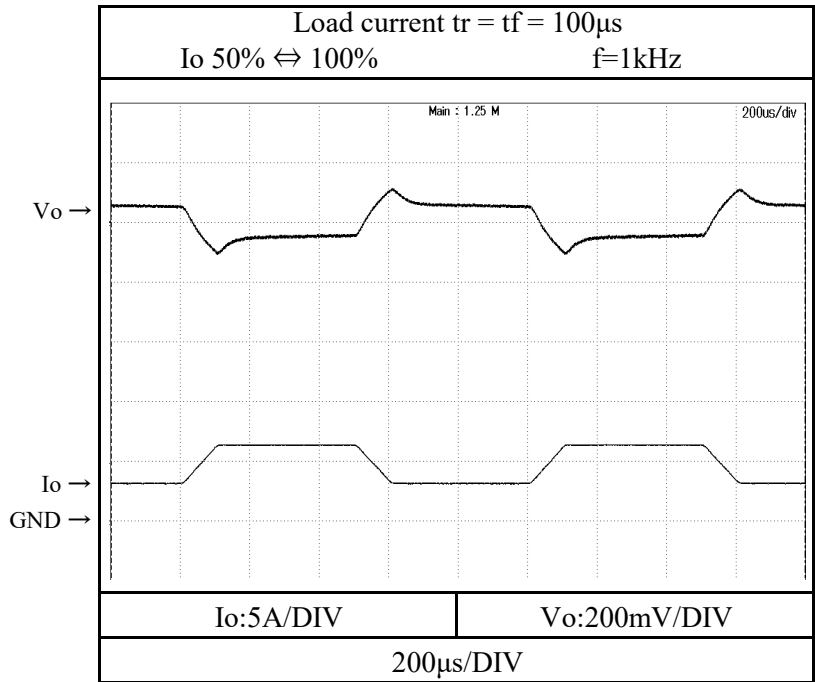

2.7 過渡応答(負荷急変)特性

Dynamic load response characteristics

Conditions

V_{in} : 110VDC

T_{bp} : 25°C

48V

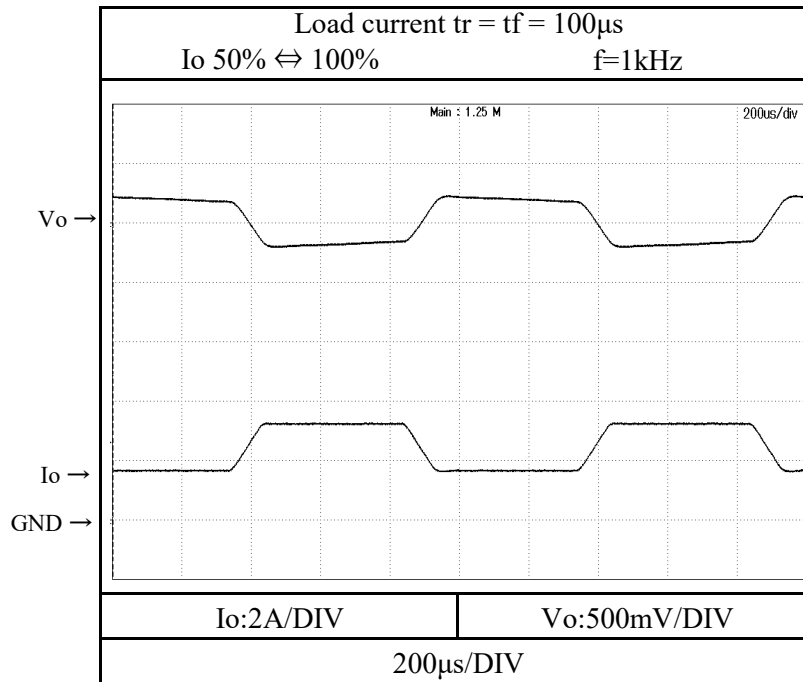

2.8 入力サージ電流(突入電流)特性

Inrush current characteristics

Conditions Vin : 110 VDC
Io : 100%
Tbp : 25°C

48V

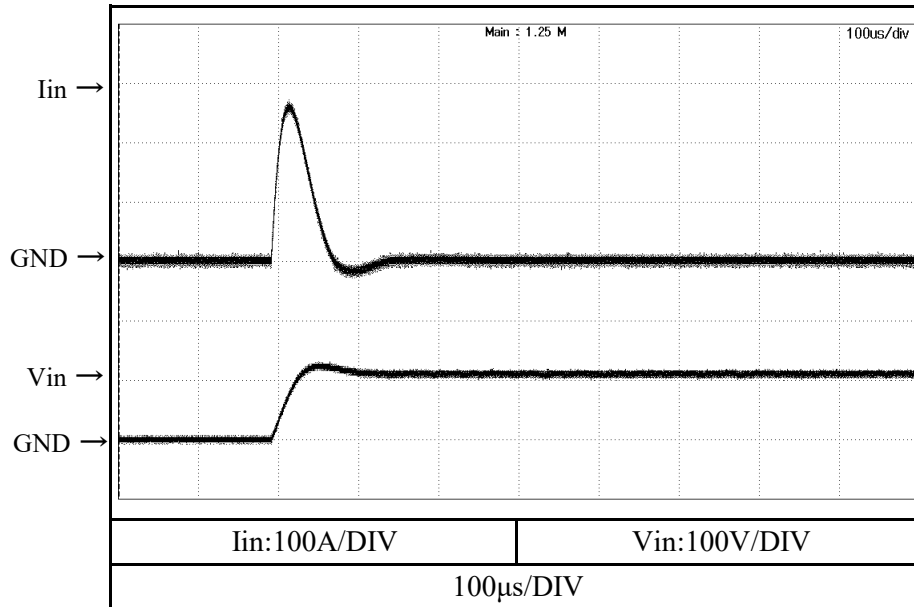

2.9 出力リップル・ノイズ波形
Output ripple and noise waveform

Conditions V_{in} : 110VDC
 I_o : 100%
 T_{bp} : 25°C

5V

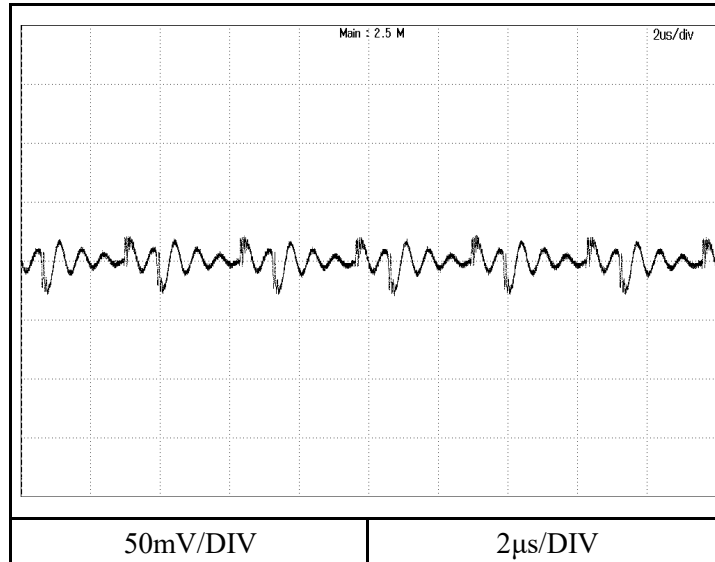

12V

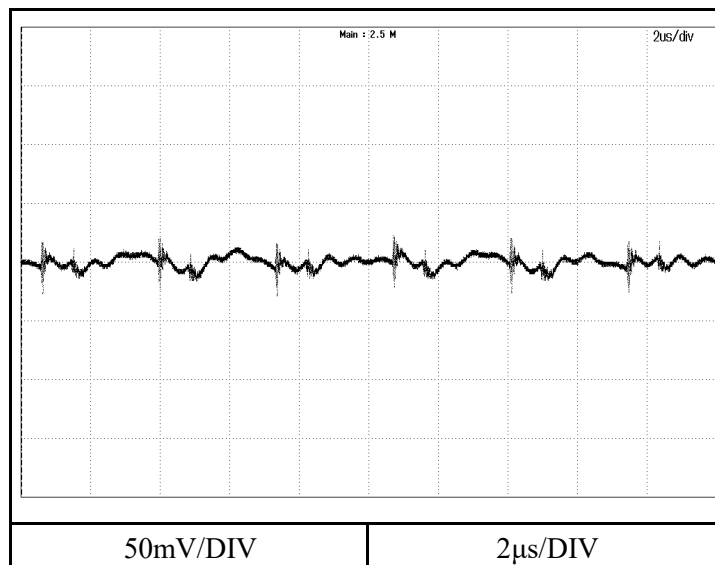

2.9 出力リップル・ノイズ波形
Output ripple and noise waveform

Conditions V_{in} : 110VDC
 I_o : 100%
 T_{bp} : 25°C

15V

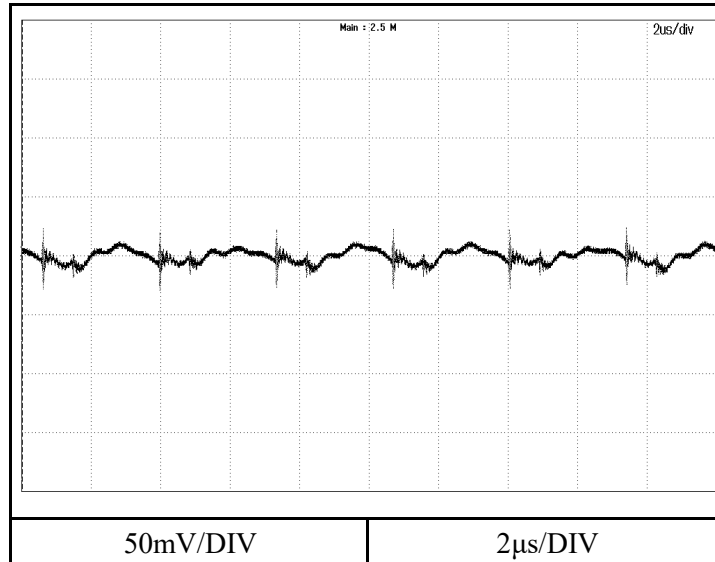

24V

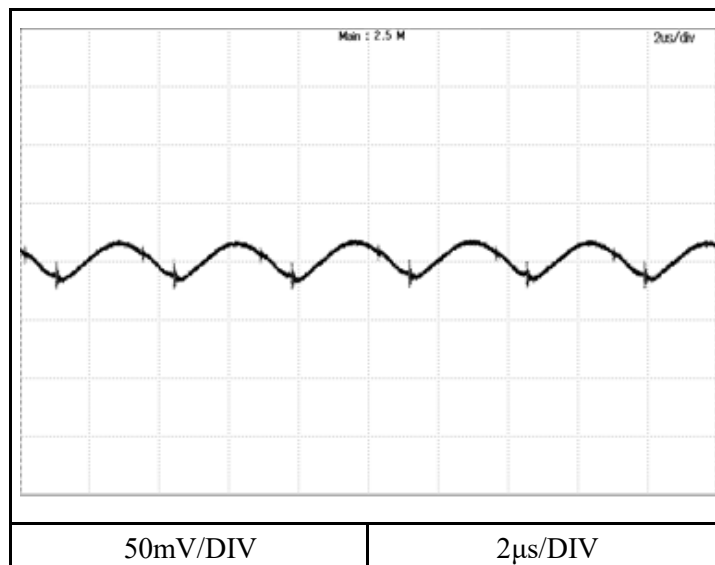

2.9 出力リップル・ノイズ波形
Output ripple and noise waveform

Conditions V_{in} : 110VDC
 I_o : 100%
 T_{bp} : 25°C

48V

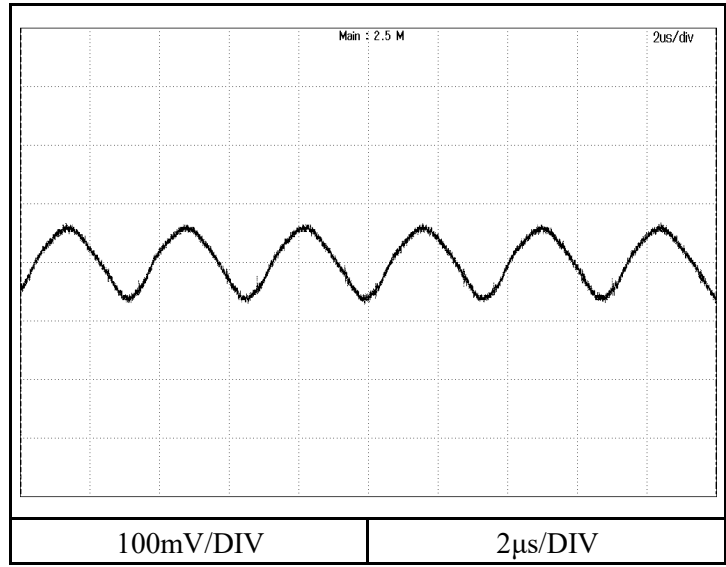

2.10 EMI特性

Electro-Magnetic Interference characteristics

(a) 雑音端子電圧 (帰還ノイズ)

Conducted Emission Noise

Conditions

Vin : 110VDC

Io : 100%

Tbp : 25°C

5V

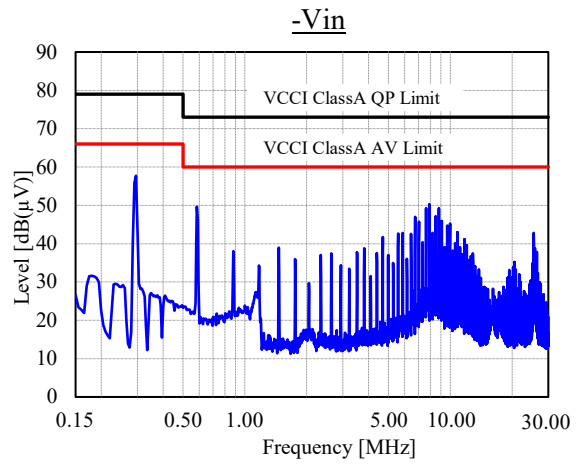
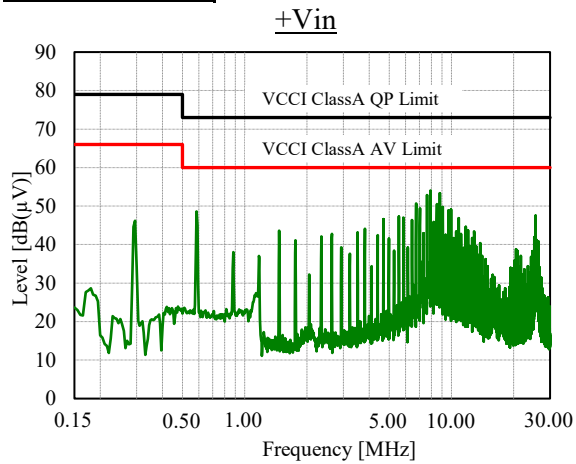

12V

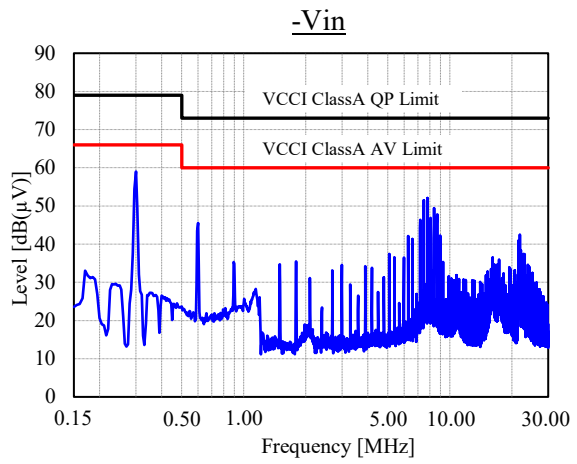
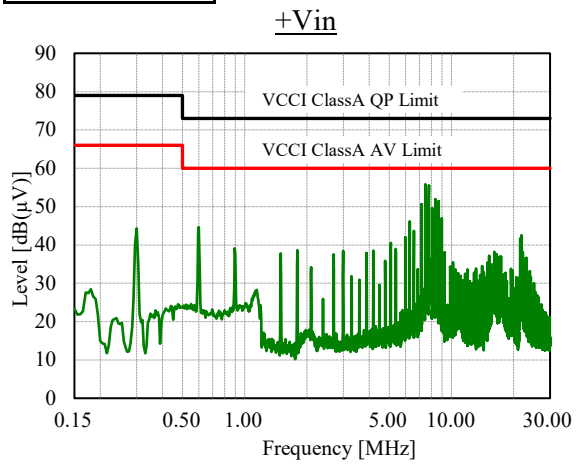

15V

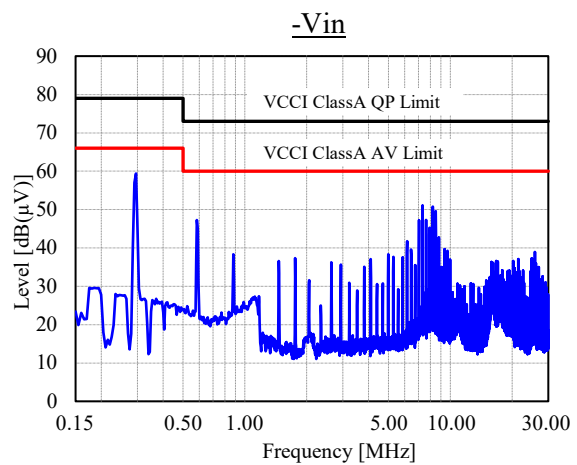
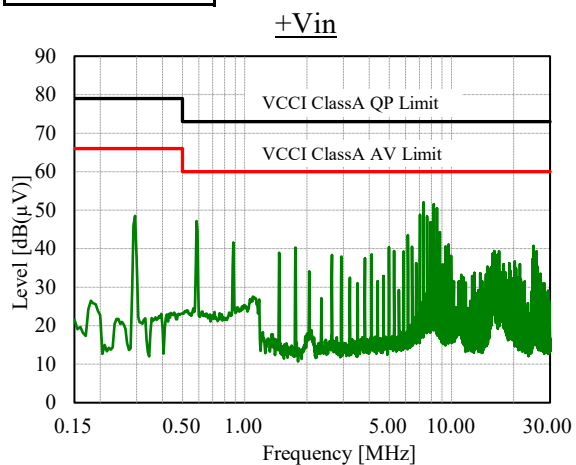

2.10 EMI特性

Electro-Magnetic Interference characteristics

(a) 雑音端子電圧 (帰還ノイズ)

Conducted Emission Noise

Conditions

Vin : 110VDC

Io : 100%

Tbp : 25°C

24V

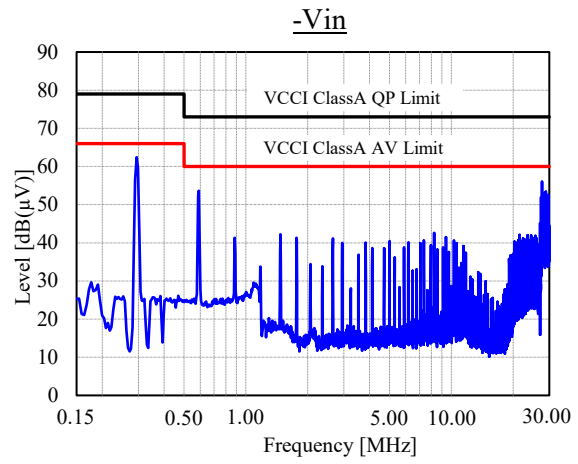
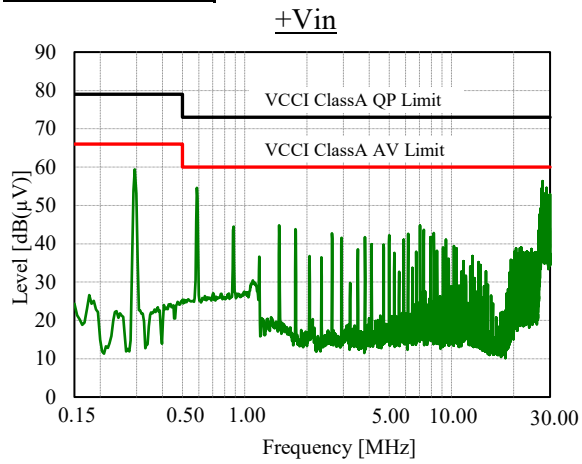

48V

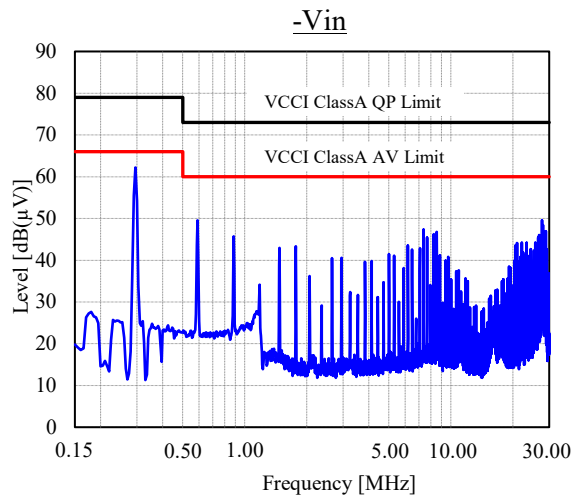
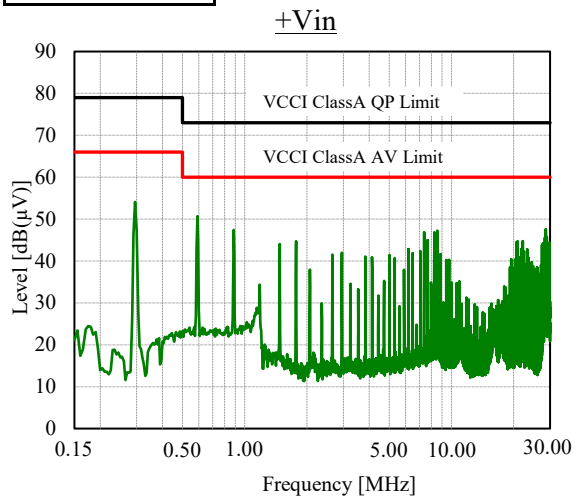

2.10 EMI特性

Electro-Magnetic Interference characteristics

(b) 雑音電界強度 (輻射ノイズ)

Radiated Emission Noise

Conditions

Vin : 110VDC

Io : 100%

Tbp : 25°C

5V

HORIZONTAL

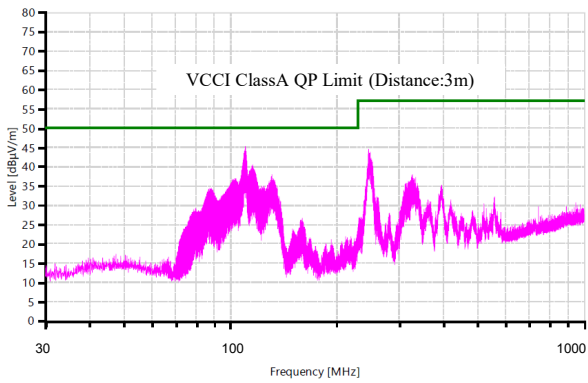

VERTICAL

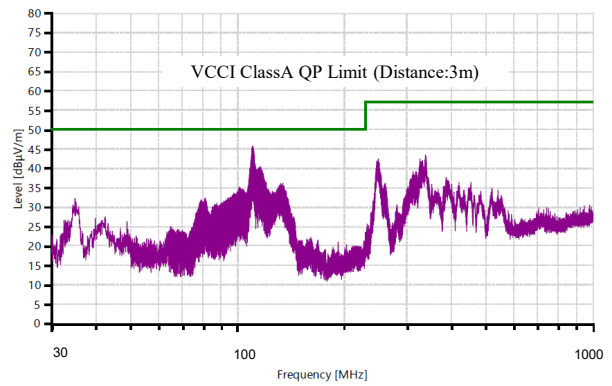

12V

HORIZONTAL

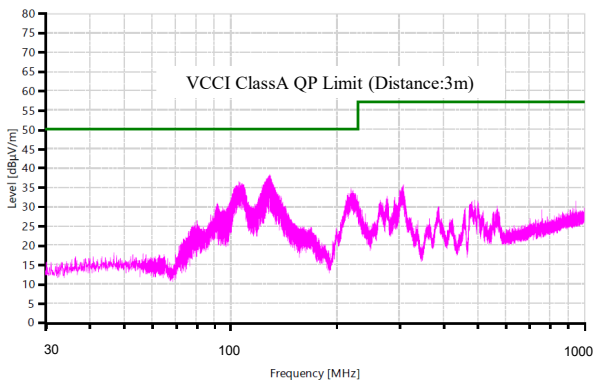

VERTICAL

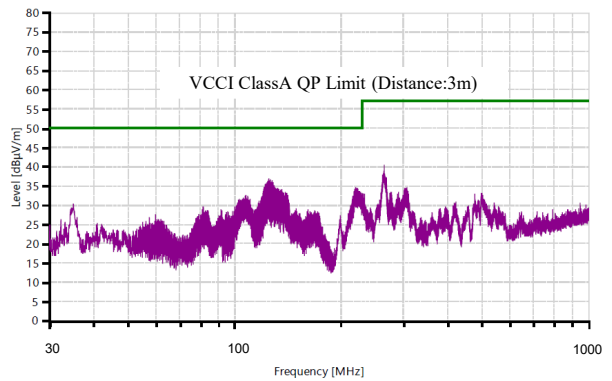

15V

HORIZONTAL

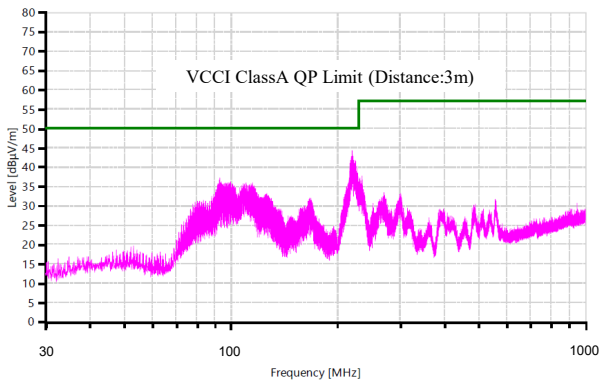

VERTICAL

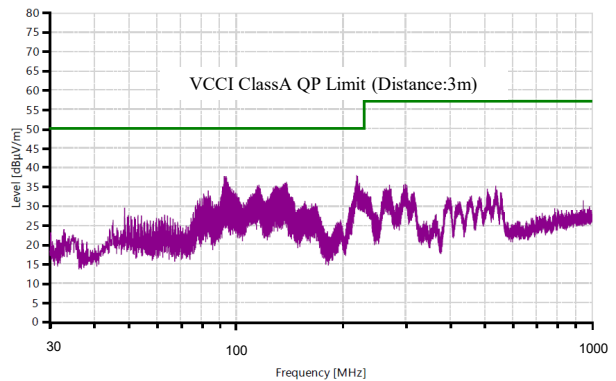

2.10 EMI特性

Electro-Magnetic Interference characteristics

(b) 雑音電界強度 (輻射ノイズ)

Radiated Emission Noise

Conditions

Vin : 110VDC

Io : 100%

Tbp : 25°C

24V

HORIZONTAL

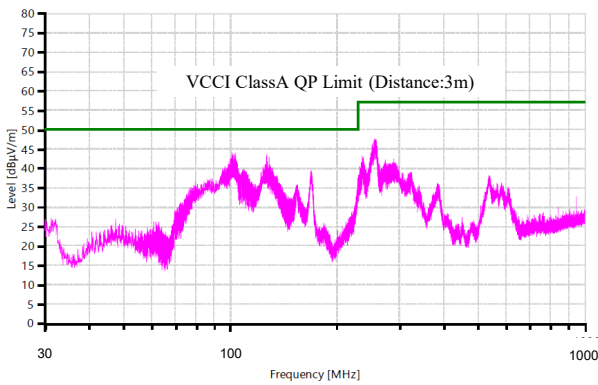

VERTICAL

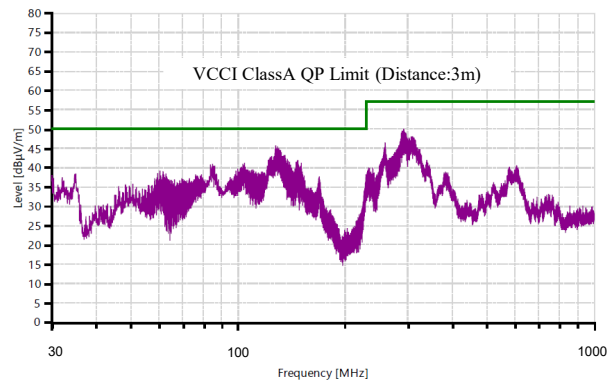

48V

HORIZONTAL

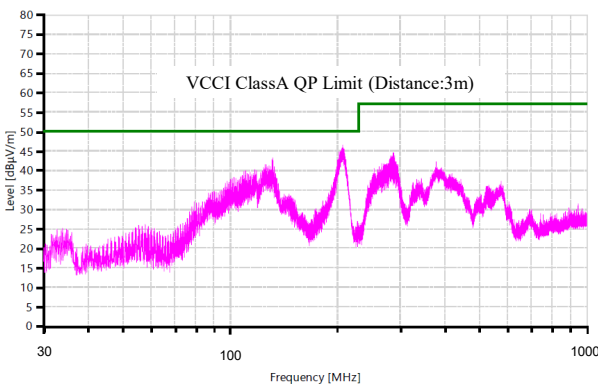

VERTICAL

