

CCG3-24-xxS

C293-01-01C

SPECIFICATIONS

ITEMS		MODEL	CCG3-24-03S	CCG3-24-05S	CCG3-24-12S	CCG3-24-15S
INPUT						
Input Voltage Range		VDC	9 - 36			
Efficiency (Typ)	(*1)	%	77	82	83	84
Input Current (Typ)	(*1)	A	0.143	0.152	0.151	0.149
OUTPUT						
Nominal Output Voltage		VDC	3.3	5	12	15
Output Voltage Accuracy	(*1)	%	±2			
Maximum Output Current		A	0.8	0.6	0.25	0.2
Maximum Output Power		W	2.64	3	3	3
Maximum Line Regulation	(*2)	mV	20	20	48	60
Maximum Load Regulation	(*3)	mV	20	20	48	60
Temperature Coefficient		-	0.02%/°C			
Maximum Ripple & Noise	(*4)	mV	200	200	200	200
Output Voltage Range	(*4)	VDC	3.135 - 3.63	4.75 - 5.5	11.4 - 13.2	14.25 - 16.5
Over Current Protection	(*5)	-	105% min.			
Over Voltage Protection		-	None			
FUNCTION						
Remote ON/OFF Control	(*6)	-	Possible			
Remote Sensing		-	None			
Parallel Operation		-	None			
Series Operation	(*6)	-	Possible			
ENVIRONMENT						
Operating Temperature	(*7)	-	-40°C - +100°C			
Storage Temperature		-	-55°C - +125°C			
Operating Humidity		-	5 - 95%RH (Non Condensing)			
Storage Humidity		-	5 - 95%RH (Non Condensing)			
Vibration	(*8)	-	At No Operating, 10 - 55Hz (Sweep for 1min.) Amplitude 1.65 mm Constant (Maximum 98m/s ²), X,Y,Z 1 hour each			
Shock	(*8)	-	490.3m/s ²			
Cooling		-	Convection Cooling / Forced Air Cooling			
ISOLATION						
Withstand Voltage	(*9)	-	Input - Output : 1.5kVDC (20mA) 1min. or 1.0kVAC (20mA) 1min.			
Isolation Resistance		-	More than 100MΩ at 25°C and 70%RH, Input - Output 500VDC			
STANDARD AND COMPLIANCE						
Safety		-	Approved by IEC/EN/UL/CSA62368-1 (Altitude ≤ 5,000m)			
MECHANICAL						
Weight (Typ.)		g	3			
Size (W x H x D)		mm	DIP : 15.7 x 11.5 x 10.4 / SMD : 15.7 x 11.8 x 10.4 (Refer to Outline Drawing)			

*Read Instruction Manual carefully, before using the power supply unit.

=NOTES=

*1. At 24VDC input voltage and maximum output current. (Ambient Temperature = +25°C.)

*2. 9 - 36VDC input voltage, constant load.

*3. No Load - Full Load, constant input voltage.

*4. External components are needed for operation. (Refer to Instruction Manual.)

*5. OCP TYPE : Hiccup, Automatic recovery.

*6. Refer to Instruction Manual.

*7. Rating - Refer to Output Derating Curve in Instruction Manual.

*8. The result is evaluated by TDK-Lambda standard measurement conditions.

The final equipment should be evaluated to meet its requirements.

*9. This specification applies to power supply module as stand-alone.

CCG3-24-xxS

C293-01-02A

BASIC CONNECTION

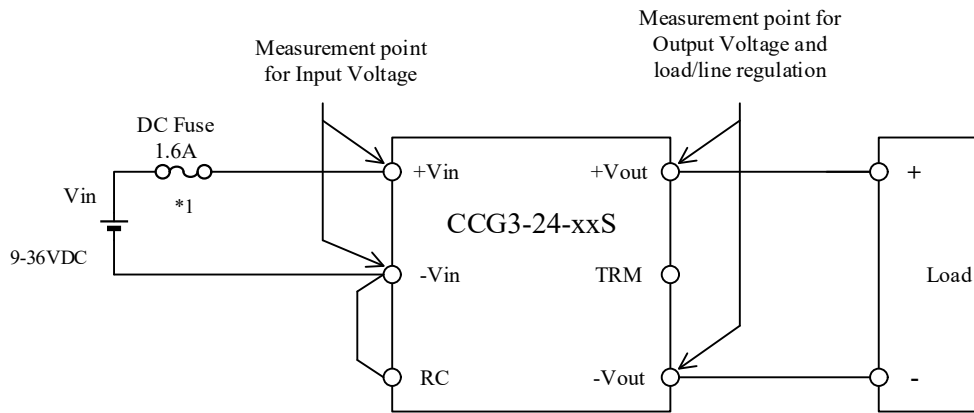

*Read instruction manual carefully, before using the power supply unit.

==NOTES==

- *1. Use an external DC fuse for each unit.