

GENESYS™ Series

Programmable DC Power Supplies

GH1kW in 1U Half-Rack 0–600V / 0–100A

GH1.5kW in 1U Half-Rack 0–600V / 0–150A

G1kW in 1U 0–600V / 0–100A

G1.7kW in 1U 0–600V / 0–170A

G2.7kW in 1U 0–600V / 0–265A

G3.4kW in 1U 0–600V / 0–340A

G5kW in 1U 0–1500V / 0–500A

G7.5kW in 1U 0–1500V / 0–375A

GSP10kW in 2U 0–600V / 0–1000A

GSP15kW in 3U 0–600V / 0–1500A

GSPL15kW in 2U 0–1500V / 0–750A

GSPL22.5kW in 3U 0–1500V / 0–1125A

GSPS30kW, 45kW, 60kW in 20U 0–600V / 0–4500A

Built in **LXI** compliant LAN, USB, RS-232 & RS-485 Interface

Optional Interface: IS420, IEEE488.2 (GPIB), MODBUS TCP or EtherCAT

EtherCAT MANUAL

EtherCAT® 

Manual Supplements

The full user manual is available on TDK-Lambda website or can be ordered, refer to User manual IA761-04-02_.

Modbus® is a registered trademark of Schneider Electric, licensed to the Modbus Organization, Inc.

EtherCAT® is a registered trademark and patented technology, licensed by Beckhoff Automation GmbH, Germany.

IA761-04-05C

This page intentionally left blank

TABLE OF CONTENTS

GENERAL INFORMATION	1
CHAPTER 1: INTRODUCTION	1
1.1 Introduction.....	1
1.2 Feature Summary.....	1
CHAPTER 2: SPECIFICATIONS	3
2.1 Power Supply Specifications.....	3
2.2 EtherCAT Specifications	3
2.3 EtherCAT (CoE) Command Speed	4
CHAPTER 3: SELECT CONTROL METHOD	6
3.1 A Variety of Control Methods	6
3.2 EtherCAT, LAN, LOCAL, Serial, or Analog Control	6
3.2.1 Select Local (Front Panel) Mode	6
3.2.2 Select RS232/485, USB (Serial), or LAN Remote Mode.....	7
3.2.3 Select EtherCAT Remote Mode	7
3.3 EtherCAT Interface Option Rear Panel View	8
3.4 EtherCAT Cable	9
3.5 Power-up the EtherCAT Power Supply.....	9
3.6 View the MAC Addresses.....	9
3.7 EtherCAT Reset	9
CHAPTER 4: PROGRAMMING USING TWINCAT 3	10
4.1 Establish TwinCAT Communication.....	10
CHAPTER 5: ETHERCAT DATA STRUCTURE	13
5.1 Programming / Monitoring Values Translation.....	13
5.2 Data Type	14
5.3 Data Access	16
5.4 Data Length (Number of SDOs/PDOs)	16
5.5 Parameters Range	16
5.6 Read / Write SDOs / PDOs	16
5.7 PDOs Mapping	17
5.8 SDOs Mapping	18
5.9 EtherCAT Unique Commands Structure	21
5.10 Sequencer Activation	26
CHAPTER 6: MULTI POWER SUPPLY CONNECTION	28
6.1 Introduction.....	28
6.2 Connection and Setup.....	28
6.3 Parallel Connection	29

This page intentionally left blank

GENERAL INFORMATION

Documentation (including this Manual) is subject to change without notice. Refer to TDK-Lambda Technical Data web page for an up-to-date documentation:

<https://www.emea.lambda.tdk.com/uk/technical-data/data.aspx?resource=Installation-Manuals>

Drivers and GUIs are updated periodically to support new features. Refer to TDK-Lambda Technical Centre web page for up-to-date drivers and GUIs:

<https://www.emea.lambda.tdk.com/uk/technical-centre/software-tools.aspx>

CHAPTER 1: INTRODUCTION

1.1 Introduction

The EtherCAT option for the **GENESYS™** power supply series allows the user to remotely program, measure, and check status of the power supply by EtherCAT (CANopen over EtherCAT) protocol implementation. Refer to **GENESYS™ SAFETY & INSTALLATION** manual (IA761-04-01_) for information on safety requirements, specifications, and installation. Refer to **GENESYS™ USER MANUAL** (IA761-04-02_) for information on power supply operation.

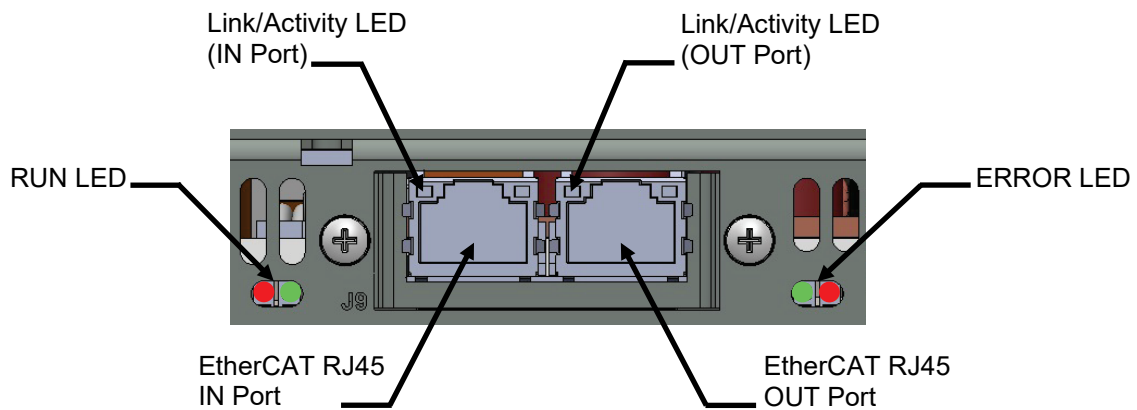

Figure 1–1: Rear Panel EtherCAT View

1.2 Feature Summary

- A. Communicate over EtherCAT network
 - CoE (CANopen over EtherCAT).
- B. Full remote programming and monitoring functions
 - Uses EtherCAT (CANopen over EtherCAT) command language.
 - Compatible with EtherCAT test & measurement utilities.
- C. Front Panel features
 - View MAC address.
 - EtherCAT (OPT) reset.
 - Remote “Blink” identity function to locate the power supply in a rack.

D. Rear Panel features (2-Port EtherCAT)

- Two Ethernet RJ-45 connectors (standard 8 pin jack).
- Allow connection of EtherCAT IN and OUT chain.
- RUN, ERROR, and two ports link/activity indicators.

CHAPTER 2: SPECIFICATIONS

2.1 Power Supply Specifications

When using EtherCAT, power supply ratings and accuracies are the same as for digital remote programming and monitoring using RS-232/485, USB, or LAN. Refer to USER MANUAL (IA761-04-02_) for those specifications.

2.2 EtherCAT Specifications

ELECTRICAL

ETHERNET	Meets IEEE 802.3 specifications
Auto-MDIX	Accepts patch or cross-over cable connection
Speed & Duplex	100Base-T networks (100 Megabits per second), Full Duplex

NETWORK CONFIGURATION

MAC Address	EtherCAT has a unique MAC address (different from the built-in LAN)
EtherCAT Reset	Reset in case of an unknown communication failure

EtherCAT PROTOCOLS

CoE	CANopen over EtherCAT
FoE	File access over EtherCAT (for firmware update only)

COMMANDS

EtherCAT PDO / SDO	EtherCAT packets follow Transmission Control Protocol
--------------------	-------------------------------------------------------

SUPPLY CONFIGURATIONS

Local Control	Supply may be controlled from the front panel even if operator is monitoring via EtherCAT connection
EtherCAT Remote Control	Supply may be controlled and monitored through EtherCAT connection
RS232/485, USB, or LAN	EtherCAT interface can be disabled to use RS232/485, USB, or LAN interfaces
Analog Control	EtherCAT can monitor power supply while analog control is used

INDICATORS

MAC Addresses	View addresses on front panel
Link & Activity LEDs	Indicate Ethernet cable connected at both ends, defines connection state and packets flow (LED per EtherCAT port)
Module RUN LED	Indicate EtherCAT device states (INIT, OPERATIONAL, PRE-OPERATIONAL, or SAFE-OPERATIONAL)
Module ERROR LED	Indicate errors and/or invalid configuration

SECURITY

Block All Protocols	All protocols except EtherCAT (CoE & FoE) are blocked
---------------------	-------------------------------------------------------

COMPLIANCE

UL, IEC, TUV, CE, ROHS, etc.	Conformances that are granted to basic power supply also apply to power supply with MODBUS TCP interface installed
---------------------------------	--------------------------------------------------------------------------------------------------------------------

2.3 EtherCAT (CoE) Command Speed

The following communication speeds are typical values only. In addition to the variability in the **GENESYS™** EtherCAT interface, there are timing variations within the controller and the network routing. Test is done using a peer-to-peer configuration.

NOTE

The following speed specifications are subject to change without notice.

Typical PDOs cycle is about 20 mSec (for all PDOs).

Typical SDOs command or query speeds (including commands not listed below):

	90% of Commands in less than:	100% of Commands in less than:
Basic Settings and Measurements		
Examples:	14 mSec	20 mSec
VOLT nn.nn VOLT?		
MEAS:VOLT?		
MEAS:CURR?		
MEAS:POW?		
OUTP OUTP?		
OUTP:MODE?		
VOLT:PROT:LEV VOLT:PROT:LEV?		
System Queries		
Examples:	22 mSec	357 mSec
SYST:ERR?		
*ESR?		
*OPT?		
SYST:PON:TIME?		
SYST:TEMP?		

90% of Commands in less than:	100% of Commands in less than:
-------------------------------------	--------------------------------------

Status Register Settings and Queries

Examples:	14 mSec	20 mSec
STAT:QUES:COND	STAT:QUES:COND?	
STAT:QUES:ENAB	STAT:QUES:ENAB?	

Identity Query

Example:	480 mSec	505 mSec
*IDN?		

Operation Complete

Example:	12 mSec	18 mSec
*OPC	*OPC?	

NOTES

- | |
|-------------------------------------------------------------------------------------------------------------------------------------------------------------------------------------------------------------------------------------------------------------------------------------------------------------------------------------------------------------------------------------------|
| <ol style="list-style-type: none">1. Data is shown as SCPI commands. Actual tests are performed on EtherCAT SDOs/PDOs.2. Commands which are longer than a single SDO might require additional execution time.3. Sequencer commands depend on the number of SDOs being read/written (sequences with 100 points might require a few seconds to store/load). |
|-------------------------------------------------------------------------------------------------------------------------------------------------------------------------------------------------------------------------------------------------------------------------------------------------------------------------------------------------------------------------------------------|

CHAPTER 3: SELECT CONTROL METHOD

3.1 A Variety of Control Methods

The **GENESYS™** power supply with EtherCAT interface is very flexible. In addition to the EtherCAT interface, there are other ways the supply can be used.

Refer to USER MANUAL (IA761-04-02_) for more details on the local operation mode (Front Panel), Serial operation mode (RS232/485 or USB), LAN operation mode (Ethernet), or Analog (Via J1, DB26HD).

3.2 EtherCAT, LAN, LOCAL, Serial, or Analog Control

The **GENESYS™** power supply, with EtherCAT interface option installed, may be operated through five interfaces. This section describes how to enable each.

	MODE	MODE DESCRIPTION	
1	EtherCAT	Control using EtherCAT connection by EtherCAT PDO (Process Data Objects) / SDO (Service Data Objects)	EtherCAT disables serial and LAN communication ports
2	LAN	Control using Ethernet connection by SCPI commands	EtherCAT is disabled if LAN is selected
3	Local	Control using the front panel buttons and encoders	EtherCAT can be used to monitor while in local mode
4	Serial	Control using RS232/485 or USB	EtherCAT is disabled if Serial is selected
5	Analog	Control using analog signals to the 26 pin 'J1' DB26HD connector	EtherCAT, LAN, Local, or Serial can be used to monitor and set protections

3.2.1 Select Local (Front Panel) Mode

The supply may be operated in the local (or front panel) mode, even when a computer is using the EtherCAT connection.

If the supply is in remote mode, the front panel REM indicator is ON. The supply may be returned to local by pressing SYST / Lock Front Panel button and acknowledged by clicking the Current encoder button.

If the power supply does not switch into local mode, then:

- If an EtherCAT program is running to change power supply settings/parameters, it will automatically go to remote with every command. Stop EtherCAT program and then return the supply to local mode by pressing SYST / Lock Front Panel button and acknowledge by clicking the Current encoder button.

- The supply may be set to Local Lockout. Use EtherCAT SDO (Service Data Object) 9199 to read or write power supply remote state, or turn the supply AC off and back on, and then press SYST / Lock Front Panel button and acknowledge by clicking the Current encoder button.

3.2.2 Select RS232/485, USB (Serial), or LAN Remote Mode

The serial (RS232/485 & USB) and LAN remote control may be selected even if EtherCAT option is installed. The serial and LAN remote modes are described in the **GENESYS™** USER MANUAL (IA761-04-02_). The EtherCAT has similar capabilities as the serial and LAN remote modes, but the EtherCAT programming language is not compatible with the serial or LAN languages (GEN or SCPI).

To select RS232/485, USB, or LAN mode:

1. Press the COMM button.
COMM LED illuminates. INTFC message appears on the Voltage display.
2. Rotate the Current encoder to select the required communication interface.
3. Press the Current encoder to accept parameter.
When the parameter is accepted, the display blinks once.
4. To exit the menu, press the COMM button or the BACK button.

3.2.3 Select EtherCAT Remote Mode

Selecting the EtherCAT mode allows programming over the Ethernet cable. Any setting and measurement may be done from a remote computer using the EtherCAT communication.

To select EtherCAT mode:

1. Press the COMM button.
COMM LED illuminates. INTFC message appears on the Voltage display.
2. Rotate the Current encoder to select the OPT communication interface.
3. Press the Current encoder to accept parameter.
When the parameter is accepted, the display blinks once.
4. To exit the menu, press the COMM button or the BACK button.

NOTE

Refer to GENESYS™ USER MANUAL (IA761-04-02_), SYSTEM[:COMMunicate]:INTerface <DSC> command to select EtherCAT (OPT) communication interface via communication (via RS232/485, USB, or LAN).

3.3 EtherCAT Interface Option Rear Panel View

The power supply rear panel, with the EtherCAT option installed, is shown below:

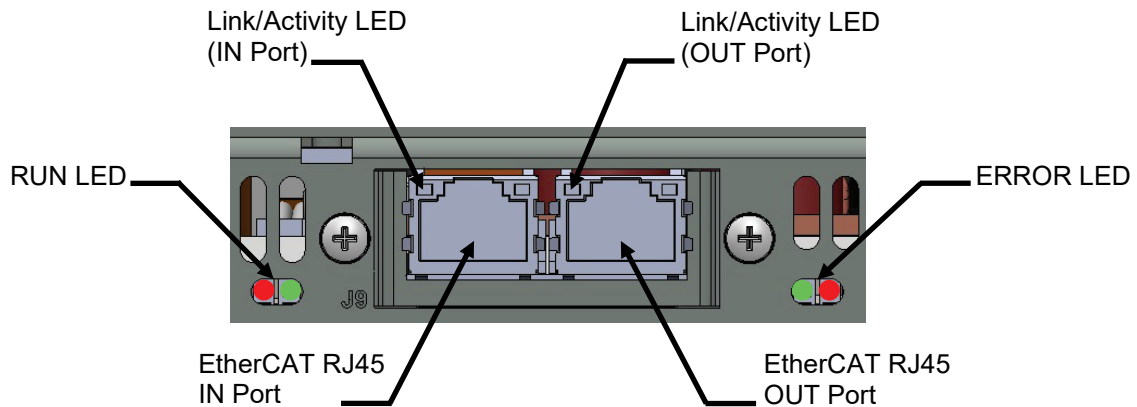

Figure 3–1: Rear Panel EtherCAT View

<p>RUN LEDs</p>	<p>Off – INIT, EtherCAT device in 'INIT'-state (or no power)</p> <p>Green – OPERATIONAL, EtherCAT device in 'OPERATIONAL'-state</p> <p>Green, blinking – PRE-OPERATIONAL, EtherCAT device in 'PRE-OPERATIONAL'-state</p> <p>Green, single flash – SAFE-OPERATIONAL, EtherCAT device in 'SAFE-OPERATIONAL'-state</p> <p>Red – Fatal Event, if RUN and ERR turn red, this indicates a fatal event, forcing the bus interface to a physically passive state. Reset via Front Panel or recycle AC power</p>
<p>ERR LED</p>	<p>Off – No error (or no power)</p> <p>Red, blinking – Invalid configuration, state change received from master is not possible due to invalid register or object settings</p> <p>Red, single flash – Unsolicited state change, slave device application has changed the EtherCAT state autonomously</p> <p>Red – Application controller failure, if RUN and ERR turn red, this indicates a fatal event, forcing the bus interface to a physically passive state. Reset via Front Panel or recycle AC power</p>
<p>Link / Activity LED</p>	<p>Off – No link, link not sensed (or no power)</p> <p>Green – Link sensed, no activity, no traffic detected</p> <p>Green, flickering – Link sensed, activity, traffic detected</p>

NOTE

EtherCAT interface supply is ready for communication as soon as Link / Activity and RUN LEDs turn Green. If communication is established before the interface is ready, communication interruptions may occur.

3.4 EtherCAT Cable

The EtherCAT cable must be supplied by the customer. It may be a standard straight “patch” CAT-5 (or better) network cable or a “crossover” cable. Cable type is auto-detected by the power supply.

NOTE

The serial link (RS-485) cable (0.5 meters long) provided with the **GENESYS™** power supply cannot be used for EtherCAT connection.

3.5 Power-up the EtherCAT Power Supply

The power supply EtherCAT option automatically detects if it is connected or disconnected from a network. EtherCAT interface supply is ready for communication as soon as Link / Activity and RUN LEDs turn Green.

1. Apply the AC power and switch ON the power supply.
2. Connect the Ethernet cable before or after the power supply is switched ON.
3. Wait for about 5 to 10 seconds. Link / Activity and RUN LEDs turn Green.

3.6 View the MAC Addresses

When the power supply is operating with the EtherCAT enabled, MAC address may be viewed on the front panel. To view the MAC address, perform the following steps:

1. Press COMM button.
2. Rotate Voltage encoder until **MAC** appears on the Voltage display, **1** appears on the Current display.
3. Press Current encoder to enter MAC configuration. Rotate Voltage encoder to view the MAC address.

The voltage display shows **MAC1-MAC6** by rotating Voltage encoder. The current display shows the corresponding MAC field.

4. To exit the menu, press the COMM button or the BACK button.

3.7 EtherCAT Reset

To reset EtherCAT in case of any unknown failure, perform the following steps:

1. Press the COMM button.
2. Rotate Voltage encoder until **OPT** appears on the Voltage display, **RESET** appears on the Current display. Press Current encoder.
3. **SURE** appears on the Voltage display, **NO** appears on the Current display. Rotate current encoder one click clockwise. **YES** appears on the Current display.
4. Press Current encoder to reset EtherCAT optional communication interface.

CHAPTER 4: PROGRAMMING USING TWINCAT 3

4.1 Establish TwinCAT Communication

Follow the steps below to establish communication between **GENESYS™** power supplies (equipped with EtherCAT interface option).

1. Create a new project in TwinCAT 3.
2. Import XML Description file (EtherCAT Slave Information) from TDK-Lambda Technical Centre (<https://www.emea.lambda.tdk.com/uk/technical-centre/software-tools.aspx>). Refer to Figure 4–1. Detailed information regarding XML file download is available in Communication Installation and Applications Guide (IA761-04-03_).

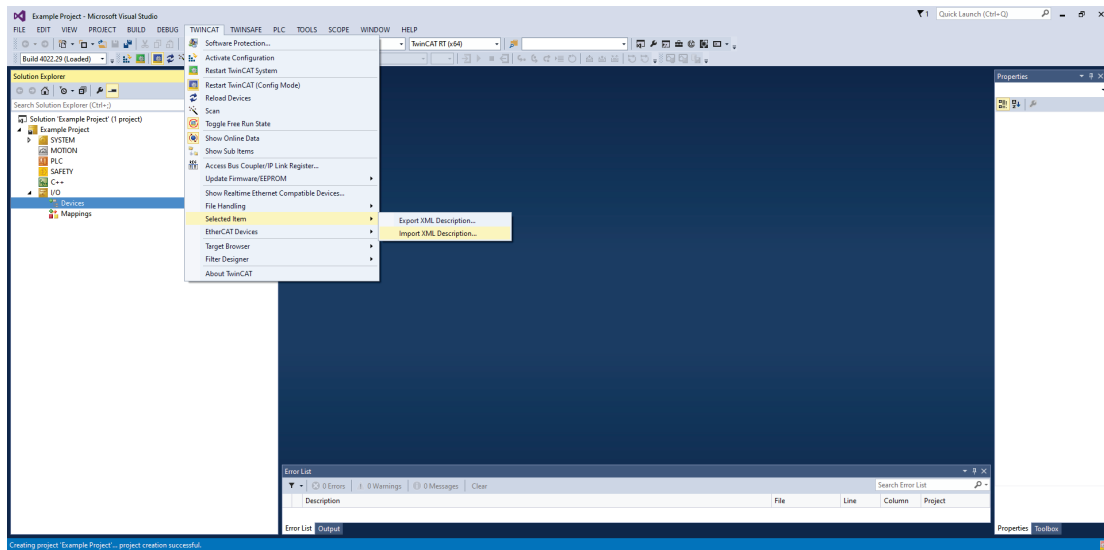

Figure 4–1: Import XML Description

3. Scan for new Devices to add **GENESYS™** power supply into TwinCAT. Refer to Figure 4–2.

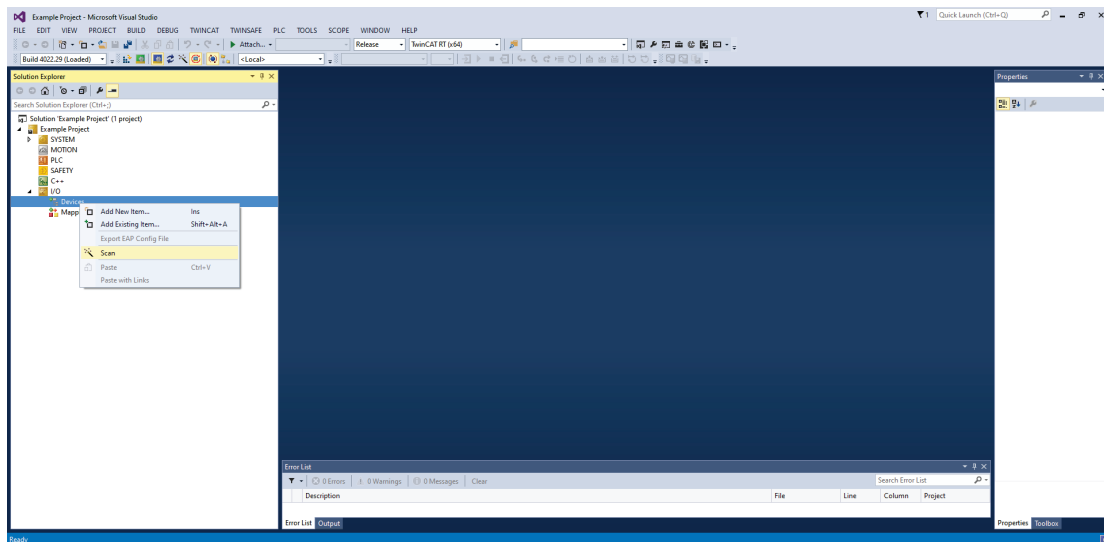

Figure 4–2: Scan for a Device

- Select I/O device to search for EtherCAT instrument. Refer to Figure 4–3.

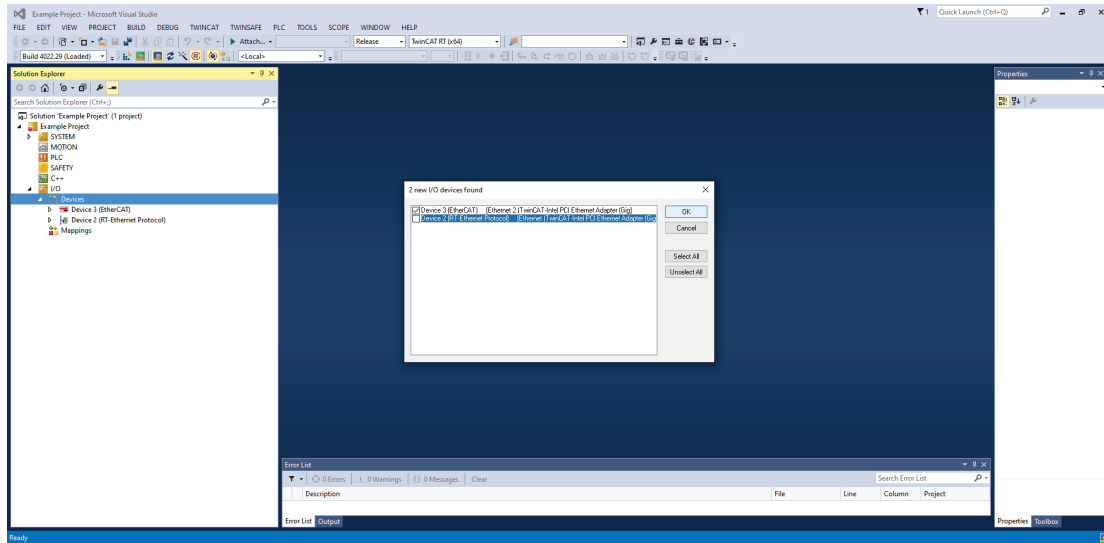

Figure 4–3: Select I/O Device

- “Scan for boxes” query pops up. Click Yes. Refer to Figure 4–4.

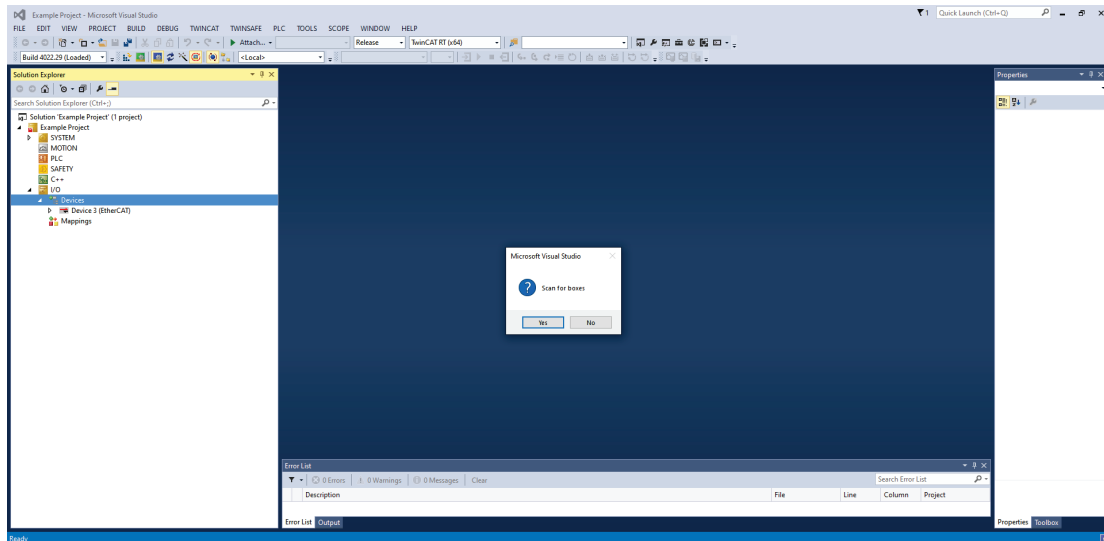

Figure 4–4: “Scan for boxes” Query

6. GENESYS™ Series Programmable DC Power Supply detected. Refer to Figure 4–5.

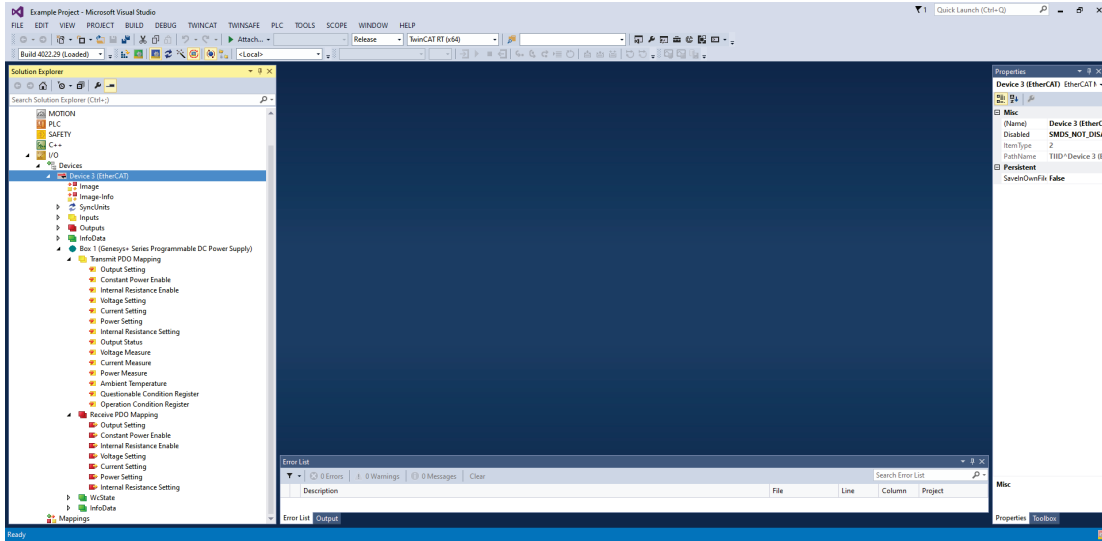

Figure 4–5: GENESYS™ Series Programmable DC Power Supply detected

7. GENESYS™ Series Programmable DC Power Supply is configured. Refer to Figure 4–6.

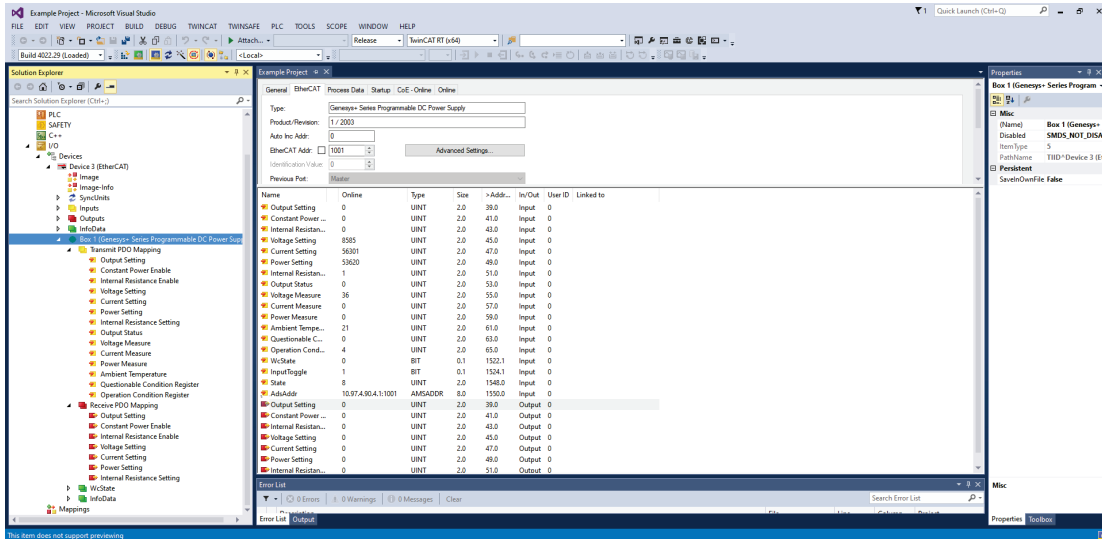

Figure 4–6: GENESYS™ Series Programmable DC Power Supply EtherCAT Tab

CHAPTER 5: ETHERCAT DATA STRUCTURE

5.1 Programming / Monitoring Values Translation

EtherCAT communication interface preserves power supply resolution and accuracy, according to specifications.

Programming / Monitoring values are represented in a form of 16 bits unsigned integer value. Rated Voltage, Current, and Power (nominal values) are represented as 53620 in a decimal base or 0xD174 in a hexadecimal base.

For example, 10 Volts, 500 Amperes, 5000 Watts power supply programming and monitoring values are represented as follows:

$$10 \text{ Volts} = 53620, 2 \text{ volts} = 10724 = 0x29E4$$

$$500 \text{ Amperes} = 53620, 400 \text{ Amperes} = 42896 = 0xA790$$

$$5000 \text{ Watts} = 53620, 2500 \text{ Watts} = 26810 = 0x68BA$$

600 Volts, 2.8 Amperes, 1680 Watts power supply programming and monitoring values are represented as follows:

$$600 \text{ Volts} = 53620, 100 \text{ Volts} = 8937 = 0x22E9$$

$$2.8 \text{ Amperes} = 53620, 2 \text{ Amperes} = 38300 = 0x959C$$

$$1680 \text{ Watts} = 53620, 680 \text{ Watts} = 21703 = 0x54C7$$

Voltage, Current, and Power values are limited to 105% (0xDBED) programming range. Protection functions such as OVP are model dependent, ranging from 110% (0xE666) up to 120% (0xFB58) according to model specifications (refer to power supply Instruction Manual).

NOTE

Values translation from real number (voltage, current, power, etc.) into unsigned 16 bits integer (hexadecimal) representation may require rounding. Round naturally to the nearest unsigned 16 bits representation.

Translation formula from actual value to programming / monitoring hexadecimal value is as follows:

$$\text{hexadecimal value} = \frac{\text{actual programming or monitoring value}}{\text{rated (nominal) value}} * 53620$$

Translation formula from programming / monitoring hexadecimal value to actual value is as follows:

$$\text{actual programming or monitoring value} = \frac{\text{hexadecimal value}}{53620} * \text{rated(nominal)value}$$

NOTE

Decimal 53620 value is represented as 0xD174 hexadecimal value. Formulas above are shown in Decimal base. Power supply operates with hexadecimal values.

5.2 Data Type

EtherCAT communication interface utilizes four data types: char, uint16, uint32, and float. Each SDO/PDO holds 16 bits of data.

Char data type is used for strings represented as ASCII characters. Size of char is 1 byte.

Char data type example - *IDN? query (address 8196, 100 bytes, 50 SDOs) for 100 Volts, 50 Amperes power supply: TDK-LAMBDA,G100-50-ETHERCAT,12345-123456,G:02.105.

SDO Address	ASCII Characters	Hexadecimal Data
8196	TD	5444
8197	K-	4B2D
8198	LA	4C41
8199	MB	4D42
8200	DA	4441
8201	,G	2C47
8202	10	3130
8203	0-	302D
8204	50	3530
8205	-E	2D45
8206	TH	5448
8207	ER	4552
8208	CA	4341
8209	T,	542C
8210	12	3132
8211	34	3334
8212	5-	352D
8213	12	3132
8214	34	3334
8215	56	3536
8216	,G	2C47
8217	:0	3A30
8218	2.	322E
8219	10	3130
8220	50 *	3530 *

NOTES

1. * Last 0 is added as the initial register value is 0, this value is not part of the *IDN? string.
2. Always start SDO access from the first SDO address according to commands mapping table (refer to Section 5.8) for each command / query. Access to any other SDO won't represent the actual data. For example, for *IDN? query, always read from address 8196.
3. SDOs 8221–8245 contain 0.

Uint16 data type is the most common type used for most of the functions. Size of uint16 is 2 bytes.

Uint16 data type example – MEASure:VOLTage[DC]? query (address 8271, 2 bytes, 1 SDO) for 100 Volts actual output value in a 100 Volts (nominal) power supply: 53620 = 0xD174

SDO Address	Decimal value	Hexadecimal Data
8271	53620	D174

Uint32 data type is used to query power supply operation time. Size of uint32 is 4 bytes.

Uint32 data type example – SYSTem:PON:TIME? query (address 9190, 4 bytes, 2 SDOs). 100 hours operation time is represented as:

SDO Address	Decimal value	Hexadecimal Data
9190	100	0064
9191	0	0000

Float data type is used for sequencer time / dwell programming and voltage / current slew rate control. Size of float is 4 bytes, represented according to IEEE 754 standard.

Float data type example – [PROGram]:LIST:DWELI? query (address 8388, 400 bytes, 200 SDOs). One second dwell for a single sequence point is represented as: 0x3F800000. Rest of the cells contain 0 if not used.

SDO Address	Decimal value	Hexadecimal Data
8388	0	0000
8389	16256	3F80

NOTES

1. Always start register access from the first register address according to commands mapping table (refer to Section 5.8) for each command / query. Access to any other SDO won't represent the actual data. For example for [PROGram]:LIST:DWELI? query, always read from address 8388.
2. First sequencer point always starts at the first register address.

5.3 Data Access

EtherCAT supports two types of data access operations: Read or Write. Query commands (SDOs) have Read access only.

NOTES

1. SDOs which don't have Read access return 0.
2. Write of an out-of-range value results in an error. It is recommended to read SDO 9128 (SYSTem:ERRor? query) to verify no errors.

5.4 Data Length (Number of SDOs/PDOs)

Each SDO length is 2 bytes. Read/Write of multiple SDOs results in Read/Write of a set of bytes multiplied by two. For example, *IDN? query start from SDO address 8196, its length is 50 SDOs, 100 bytes. To read multiple SDOs, read one SDO after another (one by one). Always start read process from the first SDO corresponding to a command.

NOTE

Always start SDO access from the first SDO address according to commands mapping table (refer to Section 5.8) for each command / query. Access to any other SDO won't represent the actual data.

5.5 Parameters Range

Each command (SDO/PDO) has a specified data range. It is mandatory to preserve data range to avoid data overrun. For example, voltage setting range is 0 up to 105% of rated (nominal) value, translated to 0x0000 up to 0xDBED. An out-of-range parameter generates an error, which can be read by SDO 9128 (SYSTem:ERRor? query).

Some other SDOs (commands) such as SDO 8194 (*ESE command), are limited to a specific range, 0 up to 255. A value out of the specified range might result in an unexpected setting value.

NOTE

It is recommended to follow parameters range specification to avoid an unexpected behavior of a power supply.

5.6 Read / Write SDOs / PDOs

GENESYS™ EtherCAT supports two types of Read / Write operations. Read single SDO / PDO or Write single SDO / PDO. Each operation is defined per command (per SDO / PDO or SDOs / PDOs range).

5.7 PDOs Mapping

EtherCAT PDOs are mapped according to the table below. Refer to **GENESYS™ USER MANUAL (IA761-04-02_)** for information regarding commands functionality.

Parameter range	SCPI command	Read / Write	Data type	Number of PDOs
0,1	OUTPut[:STATe]	W	uint16	1
0,1	[SOURce]:POWer:STATe	W	uint16	1
0,1	SYSTem:RIN:STATe	W	uint16	1
0–53620	[SOURce]:VOLTage[:LEVel][:IMMediate][:AMPLitude]	W	uint16	1
0–53620	[SOURce]:CURRent[:LEVel][:IMMediate][:AMPLitude]	W	uint16	1
0–53620	[SOURce]:POWer[:LEVel]	W	uint16	1
1–1000	SYSTem:RIN[:LEVel]	W	uint16	1
0,1	OUTPut[:STATe]?	R	uint16	1
0,1	[SOURce]:POWer:STATe?	R	uint16	1
0,1	SYSTem:RIN:STATe?	R	uint16	1
0–53620	[SOURce]:VOLTage[:LEVel][:IMMediate][:AMPLitude]?	R	uint16	1
0–53620	[SOURce]:CURRent[:LEVel][:IMMediate][:AMPLitude]?	R	uint16	1
0–53620	[SOURce]:POWer[:LEVel]?	R	uint16	1
1–1000	SYSTem:RIN[:LEVel]?	R	uint16	1
0,1	Power Supply Output (actual status)	R	uint16	1
0–53620	MEASure:VOLTage[:DC]?	R	uint16	1
0–53620	MEASure:CURRent[:DC]?	R	uint16	1
0–53620	MEASure:POWer[:DC]?	R	uint16	1
0–65535	SYSTem:TEMPerature[:AMBient]?	R	uint16	1
0–65535	STATus:QUEStionable:CONDition?	R	uint16	1
0–65535	STATus:OPERation:CONDition?	R	uint16	1

NOTES

1. Size of each PDO: 2 bytes.
2. An out-of-range parameter might result in an unpredicted behavior of the power supply.
3. Reading PDOs which have no Read access return 0.
4. PDOs which accept parameters in the range of 0,1, accept 0 as logical 0, while any number above 0 accepted as logical 1 (acts as Boolean parameter).
5. Loading a value above uint16 (above 65535) loads only 16 LSB of the value.

5.8 SDOs Mapping

EtherCAT SDOs are mapped according to the table below. Refer to **GENESYS™ USER MANUAL (IA761-04-02_)** for information regarding commands functionality.

SDO address	Parameter range	SCPI command	Read / Write	Data type	Number of SDOs
8193	0,1	*CLS	W	uint16	1
8194	0–255	*ESE	RW	uint16	1
8195	0–255	*ESR?	R	uint16	1
8196	ASCII	*IDN?	R	char	50
8246	0,1	*OPC	RW	uint16	1
8247	0–255	*OPT?	R	uint16	1
8248	0,1	*PSC	RW	uint16	1
8249	1–4	*RCL	W	uint16	1
8250	0,1	*RST	W	uint16	1
8251	1–4	*SAV	W	uint16	1
8252	0–255	*SRE	RW	uint16	1
8253	0–255	*STB?	R	uint16	1
8254	0,1	*TRG	W	uint16	1
8255	0,1	*TST?	R	uint16	1
8256	0,1	*WAI	W	uint16	1
8257	0,1	ABORt	W	uint16	1
8258	0,1	DISPlay[:WINDow]:STATe	RW	uint16	1
8259	0,1	DISPlay[:WINDow]:FLASh	RW	uint16	1
8260	0,1	DISPlay[:WINDow]:TEST	W	uint16	1
8261	0,1	INITiate[:IMMEDIATE]	W	uint16	1
8262	0,1	INITiate:CONTInuous	RW	uint16	1
8263		Reserved		uint16	1
8264	0–31	INSTrument[:N]SELect	RW	uint16	1
8265		Reserved		uint16	1
8266		Reserved		uint16	1
8267		Reserved		uint16	1
8268		Reserved		uint16	1
8269		Reserved		uint16	1
8270		Reserved		uint16	1
8271	0–53620	MEASure:VOLTage[:DC]?	R	uint16	1
8272	0–53620	MEASure:CURRent[:DC]?	R	uint16	1
8273	0–53620	MEASure:POWer[:DC]?	R	uint16	1
8274	0,1	OUTPut[:STATe]	RW	uint16	1

SDO address	Parameter range	SCPI command	Read / Write	Data type	Number of SDOs
8275	0,1	OUTPut:ENA[:STATe]	RW	uint16	1
8276	0,1	OUTPut:ENA:POLarity	RW	uint16	1
8277	0,1	OUTPut:ILC[:STATe]	RW	uint16	1
8278	1-4	OUTPut:MODE?	R	uint16	1
8279	0,1	OUTPut:PON[:STATe]	RW	uint16	1
8280	0,1	OUTPut:PROTEction:CLEar	W	uint16	1
8281	0-2	OUTPut:PROTEction:FOLDback[:MODE]	RW	uint16	1
8282	1-255	OUTPut:PROTEction:FOLDback:DELay	RW	uint16	1
8283	0,1	OUTPut:RELAy1[:STATe]	RW	uint16	1
8284	0,1	OUTPut:RELAy2[:STATe]	RW	uint16	1
8285	0-2	OUTPut:TTLTrg:MODE	RW	uint16	1
8286	0,1-9999	[PROGrama]:COUNter	RW	uint16	1
8287	0-53620	[PROGrama]:LIST:CURRent	RW	uint16	100
8387	0,1	Upload [PROGrama]:LIST:CURRent registers	W	uint16	1
8388	0.001-129600	[PROGrama]:LIST:DWELI	RW	float	200
8588	0,1	Upload [PROGrama]:LIST:DWELI registers	W	uint16	1
8589	0-53620	[PROGrama]:LIST:VOLTage	RW	uint16	100
8689	0,1	Upload [PROGrama]:LIST:VOLTage registers	W	uint16	1
8690	1-4	[PROGrama]:LOAD	RW	uint16	1
8691	0,1	[PROGrama]:STEP	RW	uint16	1
8692	1-4	[PROGrama]:STORE	W	uint16	1
8693	0-53620	[PROGrama]:WAVE:CURRent	RW	uint16	100
8793	0,1	Upload [PROGrama]:WAVE:CURRent registers	W	uint16	1
8794	0.001-129600	[PROGrama]:WAVE:TIME	RW	float	200
8994	0,1	Upload [PROGrama]:WAVE:TIME registers	W	uint16	1
8995	0-53620	[PROGrama]:WAVE:VOLTage	RW	uint16	100
9095	0,1	Upload [PROGrama]:WAVE:VOLTage registers	W	uint16	1
9096	0-100	Number of the points	RW	uint16	1
9097	0-53620	[SOURce]:VOLTage[:LEVel][:IMMEdiate][:AMPLitude]	RW	uint16	1
9098	0-53620	[SOURce]:CURRent[:LEVel][:IMMEdiate][:AMPLitude]	RW	uint16	1
9099	0-64342	[SOURce]:VOLTage:PROTEction:LEVel	RW	uint16	1
9100	1-255	[SOURce]:VOLTage:PROTEction:LOW:DELay	RW	uint16	1
9101	0,1	[SOURce]:VOLTage:PROTEction:LOW:STATe	RW	uint16	1
9102	0-51065	[SOURce]:VOLTage:PROTEction:LOW[:LEVel]	RW	uint16	1
9103	0.0001-999.99	[SOURce]:CURRent:SLEW:DOWN	RW	float	2
9105	0.0001-999.99	[SOURce]:CURRent:SLEW:UP	RW	float	2
9107	0.0001-999.99	[SOURce]:VOLTage:SLEW:DOWN	RW	float	2

SDO address	Parameter range	SCPI command	Read / Write	Data type	Number of SDOs
9109	0.0001–999.99	[SOURce]:VOLTage:SLEW:UP	RW	float	2
9111	0,1	[SOURce]:POWer:STATe	RW	uint16	1
9112	1–53620	[SOURce]:POWer[:LEVel]	RW	uint16	1
9113	0,1,2	[SOURce]:VOLTage:MODE	RW	uint16	1
9114	0,1,2	[SOURce]:VOLTage:EXTeRnal:MODE	RW	uint16	1
9115	0,1,2	[SOURce]:CURRent:MODE	RW	uint16	1
9116	0,1,2	[SOURce]:CURRent:EXTeRnal:MODE	RW	uint16	1
9117	0,1	[SOURce]:CURRent:EXTeRnal:LIMit[:STATe]	RW	uint16	1
9118	0–65535	STATus:OPERation[:EVENT]?	R	uint16	1
9119	0–65535	STATus:OPERation:CONDition?	R	uint16	1
9120	0–65535	STATus:OPERation:ENABle	RW	uint16	1
9121	0–65535	STATus:QUEStionable[:EVENT]?	R	uint16	1
9122	0–65535	STATus:QUEStionable:CONDition?	R	uint16	1
9123	0–65535	STATus:QUEStionable:ENABle	RW	uint16	1
9124	0–31	SYSTem[:COMMunicate]:ADDReSS?	R	uint16	1
9125	9600–115200	SYSTem[:COMMunicate]:BAUDrate?	R	uint16	1
9126	0–4	SYSTem[:COMMunicate]:INTerface	RW	uint16	1
9127	0,1	SYSTem:ERRor:ENABle	W	uint16	1
9128	ASCII	SYSTem:ERRor?	R	char	30
9158	1–5	SYSTem:FRST	W	uint16	1
9159	ASCII	SYSTem:FIRMWare[:VERSIon]?	R	char	30
9189	0,1	SYSTem:PANel:LOCK?	R	uint16	1
9190	0–4294967295	SYSTem:PON:TIME?	R	uint32	2
9192	0–4294967295	SYSTem:PON:TIME:AC?	R	uint32	2
9194	0,1	SYSTem:PRELoad[:STATe]	RW	uint16	1
9195	0–10000	SYSTem:PSOK:DELay	RW	uint16	1
9196	0,1	SYSTem:RANGe	RW	uint16	1
9197	1–1000	SYSTem:RIN[:LEVel]	RW	uint16	1
9198	0,1	SYSTem:RIN:STATe	RW	uint16	1
9199	0,1,2	SYSTem:REMOte[:STATe]	RW	uint16	1
9200	0,1	SYSTem:SENSe[:STATe]	RW	uint16	1
9201	0,1,2	SYSTem:SLEW[:STATe]	RW	uint16	1
9202	0–65535	SYSTem:TEMPerature[:AMBient]?	R	uint16	1
9203	0,1	TRIGger[:IMMEDIATE]	W	uint16	1
9204	0–10000	TRIGger:DELay	RW	uint16	1
9205	0,1	TRIGger:SOURce	RW	uint16	1
9206	0,1	SYSTem:PARAllel:ACKNowledge	W	uint16	1

SDO address	Parameter range	SCPI command	Read / Write	Data type	Number of SDOs
9207	ASCII	SYSTem:DATE?	R	char	7
9214	0,1	SYSTem[:COMMunicate]:WATCHdog:STATe	RW	uint16	1
9215	1–3600	SYSTem[:COMMunicate]:WATCHdog:TIME	RW	uint16	1
9216	ASCII	SYSTem:PARAllel?	R	char	6
9222	0,1	SYSTem:PSINK[:STATe]	RW	uint16	1
9223	0	Reserved		uint16	69

NOTES

1. Size of each SDO: 2 bytes.
2. An out-of-range parameter might result in an unpredicted behavior of the power supply.
3. Reading SDOs which have no Read access return 0.
4. Some special functions commands are available in SCPI only, therefore not mapped in the table above.
5. SDOs which accept parameters in the range of 0,1, accept 0 as logical 0, while any number above 0 accepted as logical 1 (acts as Boolean parameter).
6. Loading a value above uint16 (above 65535) loads only 16 LSB of the value
7. SDO address 8690 ([PROGram]:LOAD) returns 0 if a program was not previously loaded.
8. SYSTem:PSINK[:STATe] SDO requires EtherCAT firmware revision 2.013 and above.

5.9 EtherCAT Unique Commands Structure

Some EtherCAT commands have unique functionality compared to SCPI commands, due to limited SDOs operations. These commands are described in this section (All other commands' parameters / return values are according to User Manual. Refer to **GENESYS™ USER MANUAL (IA761-04-02_)**, SCPI commands for functionality explanation.

***CLS**

Parameter	To activate, write 0x0001 as parameter.
------------------	-----------------------------------------

***OPC**

Parameter	To activate, write 0x0001 as parameter.
------------------	-----------------------------------------

***OPT?**

Returns	Returns 3 for ETHERCAT interface.
----------------	-----------------------------------

***RST**

Parameter	To activate, write 0x0001 as parameter.
------------------	-----------------------------------------

***TRG**

Parameter	To activate, write 0x0001 as parameter.
------------------	-----------------------------------------

***WAI**

Parameter	To activate, write 0x0001 as parameter.
------------------	-----------------------------------------

ABORt

Parameter	To activate, write 0x0001 as parameter.
------------------	-----------------------------------------

INITiate[:IMMediate]

Parameter	To activate, write 0x0001 as parameter.
------------------	-----------------------------------------

INSTrument:[N]SElect?

Query Only	Only Read (query) operation is supported.
-------------------	-------------------------------------------

OUTPut:ENA:POLarity

Parameter	REV - 0x0000; NORM – 0x0001 as return value.
------------------	----------------------------------------------

OUTPut:MODE?

Return	OFF - 0x0001; CV – 0x0002; CC - 0x0003; CP – 0x0004 as return value.
---------------	----------------------------------------------------------------------

OUTPut:PON[:STATe]

Parameter	SAFE - 0x0000; AUTO – 0x0001 as return value.
------------------	-----------------------------------------------

OUTPut:PROTection:CLEar

Parameter	To activate, write 0x0001 as parameter.
------------------	-----------------------------------------

OUTPut:PROTection:FOLDback[:MODE]

Parameter	OFF - 0x0000; CC – 0x0001; CV - 0x0002 as return value.
------------------	---------------------------------------------------------

OUTPut:PROTection:FOLDback:DELay

Unit	100mSec. Multiply SDO value by 100mSec. For example: 1 equals 100mSec; 5 equals 500mSec.
-------------	---------------------------------------------------------------------------------------------

OUTPut:TTLTrg:MODE

Parameter	OFF - 0x0000; FSTR – 0x0001; TRIG - 0x0002 as return value.
------------------	-------------------------------------------------------------

[PROGram]:COUNter

Parameter	INFinity – write 0x0000; Number of iterations - write 1–9999 as parameter. Any value above 9999 results in INFinity.
------------------	----------------------------------------------------------------------------------------------------------------------

[PROGram]:LIST:CURRent

Parameter	Each value is loaded into a single SDO. Refer to Section 5.10 for an example of Voltage SDOs.
------------------	-----------------------------------------------------------------------------------------------

Upload [PROGram]:LIST:CURRent registers

Specific	EtherCAT specific command used to upload [PROGram]:LIST:CURRent into power supply. Refer to Section 5.10 for an example of Voltage SDOs.
-----------------	------------------------------------------------------------------------------------------------------------------------------------------

[PROGram]:LIST:DWELI

Parameter	Each value is loaded into a pair of SDOs. Low address value holds the least significant part. Refer to Section 5.10 for an example.
------------------	-------------------------------------------------------------------------------------------------------------------------------------

Upload [PROGram]:LIST:DWELI registers

Specific	EtherCAT specific command used to upload [PROGram]:LIST:DWELI into power supply. Refer to Section 5.10 for an example.
-----------------	------------------------------------------------------------------------------------------------------------------------

[PROGram]:LIST:VOLTage

Parameter	Each value is loaded into a single SDO. Refer to Section 5.10 for an example.
------------------	-------------------------------------------------------------------------------

Upload [PROGram]:LIST:VOLTage registers

Specific	EtherCAT specific command used to upload [PROGram]:LIST:VOLTage into power supply. Refer to Section 5.10 for an example.
-----------------	--------------------------------------------------------------------------------------------------------------------------

[PROGram]:STEP

Parameter	ONCE – write 0x0000; AUTO - write 0x0001 as parameter.
------------------	--------------------------------------------------------

[PROGram]:WAVE:CURRent

Parameter	Each value is loaded into a single SDO. Refer to Section 5.10 for an example of List Voltage SDOs.
------------------	----------------------------------------------------------------------------------------------------

Upload [PROGram]:WAVE:CURRent registers

Specific	EtherCAT specific command used to upload [PROGram]:WAVE:CURRent into power supply. Refer to Section 5.10 for an example of LIST Voltage SDOs.
-----------------	-----------------------------------------------------------------------------------------------------------------------------------------------

[PROGram]:WAVE:TIME

Parameter	Each value is loaded into a pair of SDOs. Low address value holds the least significant part. Refer to Section 5.10 for an example of List Dwell SDOs.
------------------	--------------------------------------------------------------------------------------------------------------------------------------------------------

Upload [PROGram]:WAVE:TIME registers

Specific	EtherCAT specific command used to upload [PROGram]:WAVE:TIME into power supply. Refer to Section 5.10 for an example of List Dwell SDOs.
-----------------	------------------------------------------------------------------------------------------------------------------------------------------

[PROGram]:WAVE:VOLTage

Parameter	Each value is loaded into a single SDO. Refer to Section 5.10 for an example of List Voltage SDOs.
------------------	----------------------------------------------------------------------------------------------------

Upload [PROGram]:WAVE:VOLTage registers

Specific	EtherCAT specific command used to upload [PROGram]:LIST:VOLTage into power supply. Refer to Section 5.10 for an example List Dwell SDOs.
-----------------	------------------------------------------------------------------------------------------------------------------------------------------

Number of the points

Parameter	EtherCAT specific command used to set the number of points of a sequence to load into a power supply. Refer to Section 5.10 for an example.
------------------	---------------------------------------------------------------------------------------------------------------------------------------------

[SOURce]:VOLTage:PROTection:LOW:DELay

Unit	100mSec. Multiply SDO value by 100mSec. For example: 1 equals 100mSec; 5 equals 500mSec.
-------------	------------------------------------------------------------------------------------------

[SOURce]:CURRent:SLEW:DOWN

Parameter	Each value is loaded into a pair of SDOs. Low address value holds the least significant part.
------------------	-----------------------------------------------------------------------------------------------

[SOURce]:CURRent:SLEW:UP

Parameter	Each value is loaded into a pair of SDOs. Low address value holds the least significant part.
------------------	-----------------------------------------------------------------------------------------------

[SOURce]:VOLTage:SLEW:DOWN

Parameter	Each value is loaded into a pair of SDOs. Low address value holds the least significant part.
------------------	-----------------------------------------------------------------------------------------------

[SOURce]:VOLTage:SLEW:UP

Parameter	Each value is loaded into a pair of SDOs. Low address value holds the least significant part.
------------------	-----------------------------------------------------------------------------------------------

[SOURce]:VOLTage:MODE

Parameter	NONE - 0x0000; LIST - 0x0001; WAVE - 0x0002 as return value.
------------------	--------------------------------------------------------------

[SOURce]:VOLTage:EXTeRnal:MODE

Parameter	DIG - 0x0000; VOL - 0x0001; RES - 0x0002 as return value.
------------------	-----------------------------------------------------------

[SOURce]:CURRent:MODE

Parameter	NONE - 0x0000; LIST - 0x0001; WAVE - 0x0002 as return value.
------------------	--------------------------------------------------------------

[SOURce]:CURRent:EXTeRnal:MODE

Parameter	DIG - 0x0000; VOL - 0x0001; RES - 0x0002 as return value.
------------------	-----------------------------------------------------------

SYSTem[:COMMunicate]:ADDRess?

Query Only	Only Read (query) operation is supported.
-------------------	-------------------------------------------

SYSTem[:COMMunicate]:BAUDrate?

Return	9600 - 0x0000; 19200 - 0x0001; 38400 - 0x0002; 57600 - 0x0003; 115200 - 0x0004 as return value.
---------------	-------------------------------------------------------------------------------------------------

SYSTem[:COMMunicate]:INTerface

Parameter	RS232 - 0x0000; RS485 - 0x0001; LAN - 0x0002; USB - 0x0003; OPT - 0x0004.
------------------	---------------------------------------------------------------------------

SYSTem:ERRor:ENABLE

Parameter	To activate, write 0x0001 as parameter.
------------------	-----------------------------------------

SYSTem:FRST

Parameter	USB - 0x0001; RS232 - 0x0002; RS485 - 0x0003; LAN - 0x0004; OPT - 0x0005.
------------------	---------------------------------------------------------------------------

SYSTem:PSOK:DELay

Unit	mSec. Data is represented in milliseconds. For example: 1 equals 1mSec; 1000 equals 1Sec.
-------------	-------------------------------------------------------------------------------------------

SYSTem:RANGe

Parameter	5 Volts range - 0x0000; 10 Volts range – 0x0001 as return value.
------------------	------------------------------------------------------------------

SYSTem:RIN[:LEVel]

Unit	mOhms. Data is represented in milliohms. For example: 1 equals 1mohm; 1000 equals 1ohm.
-------------	-----------------------------------------------------------------------------------------

SYSTem:REMote[:STATe]

Parameter	LOC - 0x0000; REM - 0x0001; LLO - 0x0002 as return value.
------------------	-----------------------------------------------------------

SYSTem:SENSe[:STATe]

Parameter	LOC - 0x0000; REM - 0x0001 as return value.
------------------	---------------------------------------------

SYSTem:SLEW[:STATe]

Parameter	OFF - 0x0000; VOLT - 0x0001; CURR - 0x0002 as return value.
------------------	-------------------------------------------------------------

TRIGger[:IMMediate]

Parameter	To activate, write 0x0001 as parameter.
------------------	-----------------------------------------

TRIGger:DELay

Unit	mSec. Data is represented in milliseconds. For example: 1 equals 1mSec; 1000 equals 1Sec.
-------------	-------------------------------------------------------------------------------------------

TRIGger:SOURce

Parameter	BUS - 0x0000; EXT - 0x0001 as return value.
------------------	---------------------------------------------

SYSTem:PARAllel:ACKnowledge

Parameter	To activate, write 0x0001 as parameter.
------------------	-----------------------------------------

NOTES

1. LAN specific commands are not available for EtherCAT interface.
2. SYSTEM[:COMMunicate]:LANGuage command is not available for EtherCAT interface.
3. SYSTem:VERSion? command is not available for EtherCAT interface.
4. Read/Write commands (defined as RW) have the same set of Return and Parameter values, although defined as Parameter in the table above.

5.10 Sequencer Activation

This section describes how to activate basic sequencer operation. Refer to **GENESYS™ USER MANUAL (IA761-04-02_)** for general information regarding sequencer functionality combined with the trigger system.

For example, the following sequence should be programmed as follows:

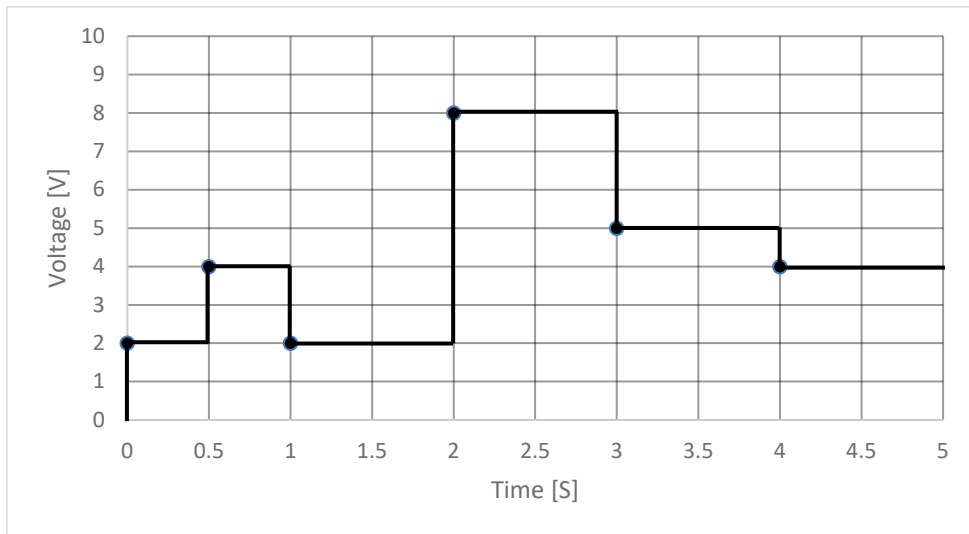

Figure 5-1: LIST Mode Example

SCPI programming language:

VOLT:MODE LIST	Select LIST Mode Sequence
LIST:VOLT 2,4,2,8,5,4	Set voltage values "2,4,2,8,5,4" Volts
LIST:DWEL 0.5,0.5,1,1,1,1	Set dwell values "0.5,0.5,1,1,1,1" Seconds
STEP AUTO	Set AUTO step execution mode "AUTO"
COUN 1	Set list execution iterations "1"
TRIG:SOUR BUS	Select BUS trigger source via communication interface or front panel
INIT:CONT OFF	Trigger system is enabled for a single trigger action

INIT	Trigger initialize
*TRG	Trigger command

EtherCAT SDOs programming:

Write 0x0001 to SDO 9113	Select LIST Mode Sequence
Write 0x29E4 to SDO 8589	Set voltage value 2 Volts
Write 0x53C8 to SDO 8590	Set voltage value 4 Volts
Write 0x29E4 to SDO 8591	Set voltage value 2 Volts
Write 0xA790 to SDO 8592	Set voltage value 8 Volts
Write 0x68BA to SDO 8593	Set voltage value 5 Volts
Write 0x53C8 to SDO 8594	Set voltage value 4 Volts
Write 0x0000 to SDO 8388	Set dwell value 0.5 Second (low register)
Write 0x3F00 to SDO 8389	Set dwell value 0.5 Second (high register)
Write 0x0000 to SDO 8390	Set dwell value 0.5 Second (low register)
Write 0x3F00 to SDO 8391	Set dwell value 0.5 Second (high register)
Write 0x0000 to SDO 8392	Set dwell value 1 Second (low register)
Write 0x3F80 to SDO 8393	Set dwell value 1 Second (high register)
Write 0x0000 to SDO 8394	Set dwell value 1 Second (low register)
Write 0x3F80 to SDO 8395	Set dwell value 1 Second (high register)
Write 0x0000 to SDO 8396	Set dwell value 1 Second (low register)
Write 0x3F80 to SDO 8397	Set dwell value 1 Second (high register)
Write 0x0000 to SDO 8398	Set dwell value 1 Second (low register)
Write 0x3F80 to SDO 8399	Set dwell value 1 Second (high register)
Write 0x0006 to SDO 9096	Indicates to load 6 points (mutual for Voltage and Dwell)
Write 0x0001 to SDO 8689	Upload Voltage registers into power supply sequencer
Write 0x0001 to SDO 8588	Upload Dwell registers into power supply sequencer
Write 0x0001 to SDO 8691	Set AUTO step execution mode "AUTO"
Write 0x0001 to SDO 8286	Set list execution iterations "1"
Write 0x0000 to SDO 9205	Select BUS trigger source via communication interface or front panel
Write 0x0000 to SDO 8262	Trigger system is enabled for a single trigger action
Write 0x0001 to SDO 8261	Trigger initialize
Write 0x0001 to SDO 8254	Trigger command

NOTES

- | |
|--------------------------------------------------------------------------------------------------------------------------------------------------------------------------------------------------------------------------------|
| <ol style="list-style-type: none"> 1. Start condition: Assume power supply output is on; Initial voltage point is 0 Volts. 2. The example above demonstrates values for a 10 Volts rated power supply. |
|--------------------------------------------------------------------------------------------------------------------------------------------------------------------------------------------------------------------------------|

CHAPTER 6: MULTI POWER SUPPLY CONNECTION

6.1 Introduction

Multiple **GENESYS™** power supplies could be connected to a single EtherCAT controller (PC, PLC, etc.).

Each **GENESYS™** power supply equipped with an EtherCAT optional communication interface has an IN Port and an OUT Port (refer to Figure 6–1: Rear Panel EtherCAT View below).

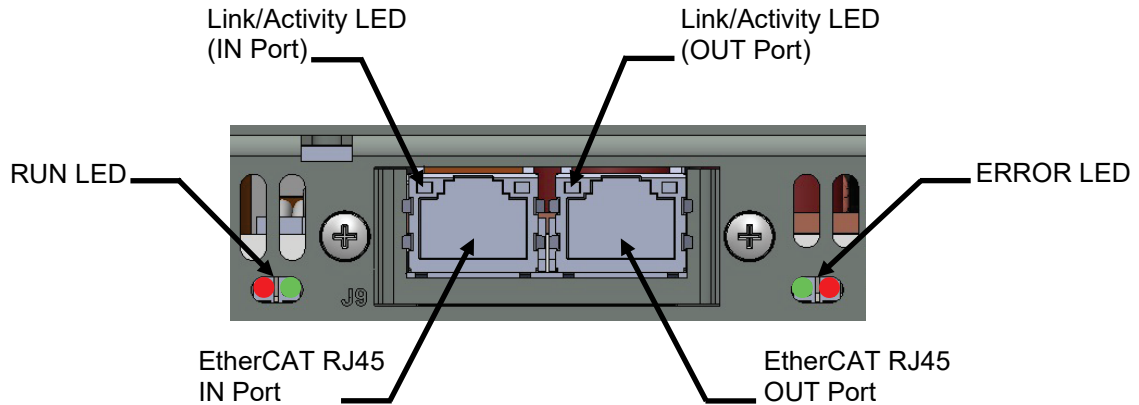

Figure 6–1: Rear Panel EtherCAT View

NOTES

1. Multi EtherCAT Power Supply Connection is available for power supplies equipped with EtherCAT optional communication interface. RS485 Daisy-Chain is not supported for EtherCAT communication interface.
2. Each power supply must have an EtherCAT optional communication interface module installed.

6.2 Connection and Setup

First unit connection: First unit could be connected directly to an EtherCAT controller (PC, PLC, etc.) or to an OUT Port of an existing EtherCAT equipment (OUT Port notation could differ according to equipment manufacturer). Select EtherCAT (OPT) communication interface, refer to Section 3.2.3.

Other units' connection: The other units are connected OUT Port to an IN Port. OUT Port of the current power supply is connected to the IN Port of the next power supply, and so forth. Select EtherCAT (OPT) communication interface, refer to Section 3.2.3.

Using EtherCAT cable, connect each unit's OUT Port to the next unit's IN Port.

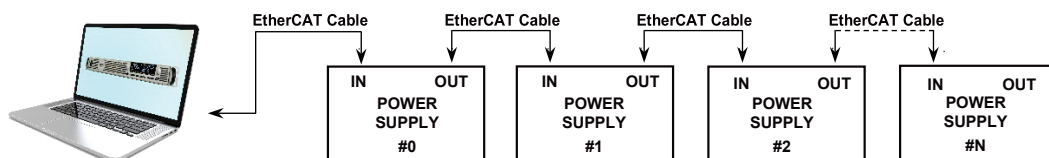

Figure 6–2: Multiple EtherCAT Power Supplies Connection

NOTES

1. Refer to Section 3.4 for EtherCAT cable definition.
2. Each EtherCAT power supply is automatically addressed by the EtherCAT controller. Refer to Figure 4–5: **GENESYS™** Series Programmable DC Power Supply detected and/or Figure 4–6: **GENESYS™** Series Programmable DC Power Supply EtherCAT Tab as an example/s.

6.3 Parallel Connection

GENESYS™ power supplies connected in parallel (refer to User Manual IA761-04-02_, Advanced Parallel Section) do not require EtherCAT communication interface in each unit. Only the **Master** unit must be equipped with an EtherCAT optional communication interface. Slave units are controlled by the Master, thus **do not** require EtherCAT optional communication interface. Refer to Figure 6–3 as an example.

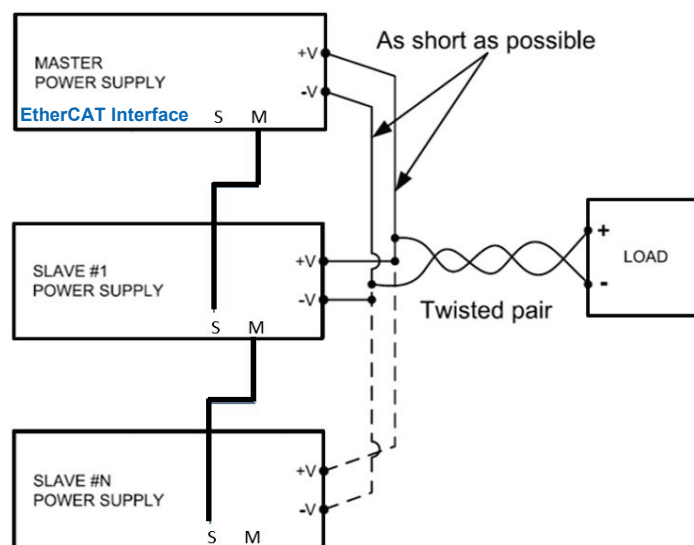

Figure 6–3: Parallel Connection

NOTES

1. MASTER POWER SUPPLY (Figure 6–3) covers all **GENESYS™** power supply models.
2. GSP/GBSP power supply is referred as a single power supply, which could be a MASTER POWER SUPPLY, or a SLAVE POWER SUPPLY, depending on advanced parallel connection.
3. GSP/GBSP MASTER POWER SUPPLY must be equipped with an EtherCAT communication optional interface. SLAVE POWER SUPPLIES are controlled by the MASTER POWER SUPPLY.

