

## General Safety Instructions:



### READ SAFETY INSTRUCTIONS

#### **Servicing:**

These products are not customer serviceable. TDK-Lambda and their authorised agents only are permitted to carry out repairs.

#### **Critical Components:**

These products are not authorised for use as critical components in nuclear control systems, life support systems or equipment for use in hazardous environments without the express written approval of the Managing Director of TDK-Lambda EMEA.

#### **Product Usage:**

These products are designed for use within a host equipment which restricts access to authorised competent personnel.

This product is a component power supply and is only to be installed by qualified persons within other equipment and must not be operated as a stand-alone product.

This product is for sale to business to business customers and can be obtained via distribution channels. It is not intended for sale to end users.

This product is a component power supply and complies with the EMC directive. The EMC performance of a component power supply will be affected by the final installation, compliance to the stated EMC standards and conformance to the EMC Directive must be confirmed after installation by the final equipment manufacturer.

For guidance with respect to test conditions please visit our website at [https://emea.tdk-lambda.com/EMC\\_guidance](https://emea.tdk-lambda.com/EMC_guidance) or contact your local TDK-Lambda sales office.

#### **Environmental:**

These products are IPX0, and therefore chemicals/solvents, cleaning agents and other liquids must not be used.

#### **Environment:**

This power supply is a switch mode power supply for use in applications within a Pollution Degree 2, overvoltage category II environment. Material Group IIIb PCB's are used within it.

#### **Output Loading:**

The output power taken from the power supply must not exceed the rating stated on the power supply label, except as stated in the product limitations in this handbook.

#### **Input Parameters:**

This product must be operated within the input parameters stated in the product limitations in this handbook.

#### **End of Life Disposal:**

The unit contains components that require special disposal. Make sure that the unit is properly disposed of at the end of its service life and in accordance with local regulations.



## RISK OF ELECTRIC SHOCK

### **High Voltage Warning:**

Dangerous voltages are present within the power supply. The professional installer must protect service personnel from inadvertent contact with these dangerous voltages in the end equipment.

**WARNING:** When installed in a Class I end equipment, this product must be reliably earthed and professionally installed.

The (+) or (-) output(s) can be earthed or left floating. The unit cover(s)/chassis must not be made user accessible. The mains input connector is not acceptable for use as field wiring terminals. Do not use mounting screws, which penetrate the unit more than 3mm (FPS/RFE1000), 6mm (HFE/RFE1600/2500 & racks). Special earthing screws are used on these products which connect the cover to the chassis. They must not be removed. If they are removed by mistake, they must be replaced with new ones and the product tested for earth bonding.

This unit must be securely mounted and its earth terminal/baseplate properly bonded to the main protective earth

before any connection to the MAINS supply is made. An internal fuse protects the unit and must not be replaced by the user. In case of internal defect, the unit must be returned to TDK-Lambda or one of their authorised agents. A suitable mechanical, electrical and fire enclosure must be provided by the end use equipment for mechanical, electric shock and fire hazard protection.

### **Energy Hazards:**

Certain modules are capable of providing hazardous energy (240VA) according to output voltage setting. Final equipment manufacturers must provide protection to service personnel against inadvertent contact with these module output terminals. If set such, that hazardous energy can occur, then the module terminals or connections must not be user accessible.

**Disconnect device:** An appropriate disconnect device shall be incorporated in the building installation wiring. Refer to the user manual of the specific model for more details.

### **Rack mounting safety instructions:**

A) Elevated Operating Ambient - If installed in a closed or multi-unit rack assembly, the operating ambient temperature of the rack environment may be greater than room ambient. Therefore, consideration should be given to installing the equipment in an environment compatible with the maximum ambient temperature (T<sub>ma</sub>) specified by the manufacturer.

B) Reduced Air Flow - Installation of the equipment in a rack should be such that the amount of air flow required for safe operation of the equipment is not compromised.

C) Mechanical Loading - Mounting of the equipment in the rack should be such that a hazardous condition is not achieved due to uneven mechanical loading.

D) Circuit Overloading - Consideration should be given to the connection of the equipment to the supply circuit and the effect that overloading of the circuits might have on overcurrent protection and supply wiring. Appropriate consideration of equipment nameplate ratings should be used when addressing this concern.

E) Reliable Earthing - Reliable earthing of rack-mounted equipment should be maintained. Particular attention should be given to supply connections other than direct connections to the branch circuit (e.g. use of power strips).



## **HOT SURFACE**

### **External Hot Surfaces:**

In accordance with local regulations for Health and Safety at work, manufacturers have an obligation to protect service engineers as well as users. In order to comply with this, a label must be fitted to these products which is clearly visible to service personnel accessing the overall equipment, and which legibly warns that surfaces of these products may be hot and must not be touched when the products are in operation.

The unit may be mounted in any orientation except inverted (mounted on its top) or vertical with the airflow downwards. The ventilation openings on these products must not be impeded. Ensure that there is at least 50mm spacing between any obstruction and the ventilation openings.

The unit cover/chassis is designed to protect skilled personnel from hazards. They must not be used as part of the external covers of any equipment where they may be accessible to operators, since under full load conditions, part or parts of the unit chassis may reach temperatures in excess of those considered safe for operator access.

**DEUTSCH****Allgemeine Sicherheitsvorschriften:****LESEN SIE DIE SICHERHEITSVORSCHRIFTEN****Wartung:**

Diese Produkte können nicht durch den Kunden gewartet werden. Nur TDK-Lambda und deren zugelassene Vertriebshändler sind zur Durchführung von Reparaturen berechtigt.

**Kritische Komponenten:**

Diese Produkte sind nicht für die Verwendung als kritische Komponenten in nuklearen Kontrollsystemen, Lebenserhaltungssystemen oder Geräten in gefährlichen Umgebungen geeignet, sofern dies nicht ausdrücklich und in Schriftform durch den Geschäftsführer von TDK-Lambda EMEA genehmigt wurde.

**Produktverwendung:**

Diese Produkte sind zur Verwendung innerhalb von Host-Anlagen gedacht, die einen auf das Fachpersonal beschränkten Zugang haben.

Dieses Produkt ist eine Stromversorgungs-Komponente und sie darf nur von qualifiziertem Personal in andere Geräte eingebaut werden und sie darf NICHT als eigenständiges ("Stand-Alone") Gerät betrieben werden.

Dieses Produkt ist für den Verkauf an Geschäftskunden entwickelt worden und es kann über Distributionskanäle bezogen werden.

Es ist NICHT für den Verkauf an Endkunden gedacht und konzipiert.

Dieses Produkt ist ein Komponenten-Netzteil und entspricht der EMV-Richtlinie. Das EMV-Verhalten eines Einbaunetzteiles wird von der Einbausituation im Endgerät maßgeblich beeinflusst. Die Übereinstimmung mit den angegebenen EMV-Normen und die Erfüllung der EMV-Richtlinie muss nach dem Einbau vom Endgerätehersteller nachgewiesen werden.

Für Anwendungshinweise besuchen Sie bitte unsere Website auf [https://emea.tdk-lambda.com/ EMC\\_guidance](https://emea.tdk-lambda.com/EMC_guidance) oder kontaktieren Sie Ihr lokales TDK-Lambda Vertriebsbüro.

**Umwelt:**

Diese Produkte sind IPX0, aus diesem Grund dürfen keine Chemikalien/Lösungsmittel, Reinigungsmittel und andere Flüssigkeiten verwendet werden.

**Umgebung:**

Dieses Netzteil ist ein Schaltnetzteil zur Verwendung in einer Umgebung mit einem Verschmutzungsgrad 2, Überspannungskategorie II. Materialgruppe IIIb mit darin verwendeten PCBs.

**Ausgangsstrom:**

Der Ausgangsstrom des Netzteiles darf die Leistung, die auf dem Label des Netzteiles vermerkt ist, nur dann überschreiten, wenn dies in den Produktgrenzen dieses Handbuches ausgezeichnet ist.

**Eingangsparameter:**

Dieses Produkt muss innerhalb der Eingangsparameter, die in den Produktgrenzen dieses Handbuches angegeben sind, betrieben werden.

**Entsorgung am Ende der Betriebszeit:**

Das Gerät enthält Komponenten die unter Sondermüll fallen. Das Gerät muss am Ende der Betriebszeit ordnungsgemäß und in Übereinstimmung mit den regionalen Bestimmungen entsorgt werden.

**GEFAHR DURCH ELEKTRISCHEN SCHLAG****Hochspannungswarnung:**

Innerhalb des Netzteiles gibt es gefährliche Spannungen. Der Elektroinstallateur muss das Wartungspersonal vor versehentlichem Kontakt mit den gefährlichen Spannungen im Endgerät schützen.

**WARNUNG!** Falls Sie unser Netzgerät in eine Anwendung mit Schutzklasse 1 eingebaut haben, stellen Sie sicher, dass es fachgerecht installiert und zuverlässig geerdet ist.

Die (+) oder (-) Ausgänge können geerdet werden oder unangeschlossen bleiben.

Die Abdeckung des Gerätes/das Gehäuse darf für den Benutzer nicht zugänglich sein. Der Haupteingangsanschluss ist nicht für die Verwendung als Feldverdrahtungsanschluss geeignet. Verwenden Sie keine Befestigungsschrauben, die mehr als 3mm (FPS/RFE 1000), 6mm (HFE/RFE 1600/2500, racks) in das Gerät eindringen. Zur Befestigung der Abdeckung am Gehäuse werden für diese Produkte spezielle Erdungsschrauben verwendet. Diese dürfen nicht entfernt werden. Sollten sie versehentlich entfernt werden, müssen sie durch neue ersetzt und das Produkt auf Erdschluss geprüft werden. Vor dem Anschließen an die AC-Hauptstromversorgung muss das Gerät sicher montiert und die Grundplatte korrekt an die Schutz Erde angeschlossen sein. Eine interne Sicherung schützt das Gerät und darf durch den Benutzer nicht ausgetauscht werden. Im Fall von internen Defekten muss das Gerät an TDK-Lambda oder einen der autorisierten Vertriebshändler zurückgeschickt werden. Ein geeignetes mechanisches, elektrisches und brandgeschütztes Gehäuse muss als Schutz vor der Gefahr von mechanischen Risiken, Stromschlägen und Brandschutz in dem Endgerät vorgesehen werden.

### **Gefahren durch elektrische Energie:**

Von bestimmten Modulen kann je nach Einstellung der Ausgangsspannung gefährliche elektrische Energie ausgehen (240 VA). Die Endgerätehersteller müssen einen Schutz für Servicepersonal vor unbeabsichtigtem Kontakt mit den Ausgangsanschlüssen dieser Module vorsehen. Kann aufgrund der Einstellung gefährliche elektrische Energie auftreten, dürfen die Modulanschlüsse für den Benutzer nicht zugänglich sein.

**Trennvorrichtung:** Eine geeignete Trennvorrichtung muss in die Verkabelung der Gebäudeinstallation integriert werden. Weitere Einzelheiten finden Sie im Benutzerhandbuch des jeweiligen Modells.

### **Sicherheitshinweise für die Gestellmontage:**

A) Erhöhte Betriebsumgebung - Wenn das Gerät in einem geschlossenen oder mehrteiligen Gestell installiert wird, kann die Betriebsumgebungstemperatur der Gestellumgebung höher sein als die Raumtemperatur. Daher sollte die Installation des Geräts in einer Umgebung in Betracht gezogen werden, die mit der vom Hersteller angegebenen maximalen Umgebungstemperatur (T<sub>ma</sub>) kompatibel ist.

B) Reduzierter Luftstrom - Die Installation der Geräte in einem Gestell sollte so erfolgen, dass der für den sicheren Betrieb der Geräte erforderliche Luftstrom nicht beeinträchtigt wird.

C) Mechanische Belastung - Die Montage des Geräts im Gestell sollte so erfolgen, dass durch ungleichmäßige mechanische Belastung kein gefährlicher Zustand entsteht.

D) Überlastung des Stromkreises - Der Anschluss des Geräts an den Versorgungsstromkreis und die Auswirkungen, die eine Überlastung der Stromkreise auf den Überspannungsschutz und die Versorgungskabel haben könnte, sollten berücksichtigt werden. Berücksichtigen Sie dabei die Angaben auf dem Typenschild des Geräts.

E) Zuverlässige Erdung - Die zuverlässige Erdung von Geräten im Gestell sollte beibehalten werden. Besondere Aufmerksamkeit sollte anderen Versorgungsanschlüssen als dem direkten Anschluss an den Zweigstromkreis (z. B. Verwendung von Steckdosenleisten) gewidmet werden.



## **HEISSE OBERFLÄCHEN**

### **Äußere heiße Oberflächen:**

In Übereinstimmung mit den regionalen Bestimmungen für Gesundheit und Sicherheit bei der Arbeit ist der Hersteller für den Schutz von Wartungspersonal und Benutzern verantwortlich. Um diesen Bestimmungen gerecht zu werden, muss auf den Produkten ein Label angebracht werden, das deutlich sichtbar für das Wartungspersonal mit Zugriff auf die gesamte Anlage ist, und das gut lesbar auf die eventuell heiße Oberfläche des Gerätes hinweist und das Berühren des Produktes in Betrieb untersagt.

Das Gerät darf in jeder Position befestigt werden, mit Ausnahme über Kopf (umgekehrt) oder vertikal mit dem Luftstrom abwärts.

Die Belüftungsöffnungen an diesem Produkt dürfen nicht blockiert werden. Achten Sie darauf, dass mindestens 50 mm Abstand zwischen Hindernissen und den Belüftungsöffnungen bleibt.

Die Geräteabdeckung/das Gehäuse ist so entworfen, dass das Fachpersonal vor Gefahren geschützt wird. Sie dürfen nicht als Teil der externen Abdeckung für Geräte verwendet werden, die für den Betreiber zugänglich sein müssen, da Teile oder das gesamte Gerätegehäuse unter voller Auslastung übermäßige Temperaturen erreichen kann, die für den Zugang des Betreibers nicht mehr als sicher betrachtet werden.

**FRANÇAIS****Consignes générales de sécurité:****LIRE LES CONSIGNES DE SECURITE****Entretien:**

Ces produits ne peuvent pas être réparés par l'utilisateur. Seuls, TDK-Lambda et ses agents agréés sont autorisés à effectuer des réparations.

**Composants critiques:**

Ces produits ne doivent pas être utilisés en tant que composants critiques dans des systèmes de commande nucléaire, dans des systèmes de sauvetage ou dans des équipements utilisés dans des environnements dangereux, sans l'autorisation écrite expresse du directeur général de TDK-Lambda EMEA.

**Utilisation du produit:**

Ces produits sont conçus pour être utilisés dans un équipement hôte dont l'accès n'est autorisé qu'aux personnes compétentes. Ce produit est une alimentation considérée comme un composant devant être installé par des personnes qualifiées, dans un autre équipement. Il ne doit pas être utilisé en tant que produit fini.

Ce produit est destiné à la vente entre entreprises et peut être obtenu via des canaux de distribution. Il n'est pas prévu à la vente pour les particuliers.

Ce produit est un composant d'alimentation électrique et est conforme à la directive EMC. La performance CEM d'une alimentation considérée comme un composant d'un équipement sera affectée par l'équipement final, la conformité aux normes CEM énoncée et la conformité à la directive CEM doivent être confirmées après installation de l'alimentation par le fabricant de l'équipement final.

Pour obtenir des conseils concernant nos conditions d'essai, veuillez consulter notre site Web à l'adresse [https://emea.tdk-lambda.com/EMC\\_guidance](https://emea.tdk-lambda.com/EMC_guidance) ou contacter votre bureau de vente local TDK-Lambda.

**Environnement:**

Ces produits sont IPX0, et donc on ne doit pas utiliser des produits chimiques/solvants, des produits de nettoyage et d'autres liquides.

**Environnement fonctionnel:**

Cette alimentation fonctionne en mode commutation pour utilisation dans des applications fonctionnant dans un environnement avec Degré de Pollution 2 et catégorie de surtension II. Elle utilise des cartes des circuits imprimés (PCB) de Groupe IIIb.

**Intensité soutirée:**

L'intensité soutirée de l'alimentation ne doit pas dépasser l'intensité nominale marquée sur la plaque signalétique, sauf indications contraires dans les limitations du produit décrit dans ce manuel."

**Paramètres d'entrée:**

Ce produit doit être utilisé à l'intérieur des paramètres d'entrée indiqués dans les limitations du produit dans ce manuel.

**Elimination en fin de vie:**

L'alimentation contient des composants nécessitant des dispositions spéciales pour leur élimination. Vérifiez que cette alimentation est mise au rebut correctement en fin de vie utile et conformément aux réglementations locales en vigueur."

**RISQUE DE CHOC ELECTRIQUE****Attention-Danger haute tension:**

Des tensions dangereuses sont présentes dans l'alimentation. L'installateur doit protéger le personnel d'entretien contre un contact involontaire avec ces tensions dangereuses dans l'équipement final.

**AVERTISSEMENT:** Si ce produit est installé dans un équipement final de classe I, il doit être mis à la terre de manière

fiable et installé par un professionnel averti.

Les sorties (+) ou (-) peuvent être raccordées à la terre ou laissées flottantes. Le couvercle/châssis de l'alimentation ne doit pas être accessible à l'utilisateur.

Le connecteur d'entrée d'alimentation principale ne doit pas être utilisé comme borne de raccordement. N'utilisez pas de vis pénétrant dans le module sur une profondeur supérieure à 3mm (FPS/RFE 1000), 6mm (HFE/RFE 1600/2500, racks). Des vis de terre spéciales sont utilisées sur ces produits pour raccorder le couvercle au châssis. Elles ne doivent pas être enlevées. Si elles sont enlevées par erreur, elles doivent être remplacées et le produit doit être testé pour vérifier que le raccordement à la terre est correct.

Ce module doit être solidement installé et sa plaque de base doit être raccordée à la terre de protection principale avant d'être raccordée à l'alimentation principale AC. Un fusible interne protège le module et ne doit pas être remplacé par l'utilisateur. En cas de défaut interne, le module doit être renvoyé à TDK-Lambda ou l'un de ses agents agréés. Une enceinte appropriée doit être prévue par l'utilisateur final pour assurer la protection contre les chocs mécaniques, les chocs électriques et l'incendie.

### **Energies dangereuses:**

Certains modules peuvent générer une énergie dangereuse (240 VA) selon le réglage de tension de sortie. Le fabricant de l'équipement final doit assurer la protection des techniciens d'entretien contre un contact involontaire avec les bornes de sortie de ces modules. Si une telle tension dangereuse risque de se produire, les bornes ou les connexions du module ne doivent pas être accessibles par l'utilisateur.

**Dispositif de déconnexion** : Un dispositif de déconnexion approprié sera intégré au câblage de l'installation du bâtiment. Consultez le manuel d'utilisation du modèle spécifique pour plus de détails.

### **Consignes de sécurité pour le montage en rack :**

A) Température ambiante de fonctionnement élevée : Si l'équipement est installé dans un rack fermé ou à plusieurs unités, la température ambiante de fonctionnement de l'environnement du rack peut être supérieure à la température ambiante de la pièce. Par conséquent, il convient de privilégier lors de l'installation de l'équipement un environnement compatible avec la température ambiante maximale (T<sub>ma</sub>) recommandée par le fabricant.

B) Débit d'air réduit : L'installation de l'équipement en rack doit permettre que la quantité de débit d'air nécessaire pour un fonctionnement sûr de l'équipement ne soit pas compromise.

C) Chargement mécanique : Le montage de l'équipement en rack doit être exempt de tout risque dû à une charge mécanique inégale.

D) Surcharge des circuits : Une attention particulière doit être apportée lors du raccord de l'équipement au circuit d'alimentation électrique, et à l'effet que la surcharge des circuits pourrait avoir sur la protection contre les surintensités et le câblage d'alimentation. Il est recommandé à cet effet de tenir compte des valeurs nominales sur la plaque signalétique de l'équipement.

E) Mise à la terre fiable : Une mise à la terre fiable de l'équipement monté en rack doit être maintenue. Une attention particulière doit être accordée aux raccords d'alimentation autres que les raccords directs au circuit de dérivation (par exemple, l'utilisation de multiprises).



## **SURFACE CHAUDE**

### **Surfaces chaudes extérieures:**

Conformément aux réglementations locales concernant la santé et la sécurité sur les lieux de travail, les fabricants doivent protéger les techniciens d'entretien et les utilisateurs. Pour cela, une plaque signalétique doit être installée sur ces produits, et cette plaque doit être bien visible pour les techniciens d'entretien intervenant sur l'équipement, et elle doit indiquer de manière bien visible par les surfaces de ces produits peuvent être chaudes et qu'elles ne doivent pas être touchées lorsque les produits fonctionnent.

Le module peut être monté suivant une orientation quelconque, sauf en position inversée (monté sur son sommet) ou en position verticale avec écoulement d'air descendant.

Les orifices de ventilation sur ces produits ne doivent pas être obstrués. Vérifiez qu'il y a un espace libre d'au moins 50 mm entre une obstruction et les orifices de ventilation.

Le couvercle et le châssis du module sont conçus pour protéger des personnels expérimentés. Ils ne doivent pas être utilisés comme couvercles extérieurs d'un équipement, accessible aux opérateurs car en condition de puissance maximum, des parties du châssis peuvent atteindre des températures considérées comme dangereuses pour l'opérateur.

**ITALIANO****Norme generali di sicurezza:****SI PREGA DI LEGGERE LE NORME DI SICUREZZA****Manutenzione:**

Il cliente non può eseguire alcuna manutenzione su questi prodotti. L'esecuzione delle eventuali riparazioni è consentita solo a TDK-Lambda e ai suoi agenti autorizzati.

**Componenti critici:**

Non si autorizza l'uso di questi prodotti come componenti critici all'interno di sistemi di controllo nucleari, sistemi necessari alla sopravvivenza o apparecchiature destinate all'impiego in ambienti pericolosi, senza l'esplicita approvazione scritta dell'Amministratore Delegato di TDK-Lambda EMEA.

**Uso dei prodotti:**

Questi prodotti sono progettati per l'uso all'interno di un'apparecchiatura ospite che limiti l'accesso al solo personale competente e autorizzato. Questo prodotto è da considerarsi come un alimentatore professionale componente e come tale deve essere installato da personale qualificato all'interno di altre apparecchiature e non può essere utilizzato come prodotto indipendente.

Questo prodotto non è inteso per la vendita al dettaglio o agli utilizzatori finali.

Questo prodotto è un alimentatore componenti ed è conforme alla direttiva EMC. Le prestazioni EMC di un alimentatore utilizzato come componente di un'apparecchiatura saranno influenzate dal montaggio finale, la conformità alle norme EMC indicate e la conformità alla direttiva EMC dovranno essere confermata dopo l'installazione dell'alimentatore da parte del produttore dell'apparecchiatura finale.

Per indicazioni riguardanti le condizioni di test si prega di visitare il nostro sito web all'indirizzo [https://emea.tdk-lambda.com/EMC\\_guidance](https://emea.tdk-lambda.com/EMC_guidance) o contattare l'ufficio vendite TDK-Lambda locale.

**Condizioni ambientali:**

Questi prodotti sono classificati come IPX0, dunque non devono essere utilizzati sostanze chimiche/solventi, prodotti per la pulizia o liquidi di altra natura.

**Ambiente:**

Questo prodotto è un alimentatore a commutazione, destinato all'uso in applicazioni rientranti in ambienti con le seguenti caratteristiche: Livello inquinamento 2, Categoria sovratensione II. Questo prodotto contiene schede di circuiti stampati in materiali di Gruppo IIIb.

**Carico in uscita:**

La potenza in uscita ottenuta dall'alimentatore non deve superare la potenza nominale indicata sulla targhetta dell'alimentatore, fatto salvo dove indicato nei limiti per il prodotto specificati in questo manuale.

**Parametri di alimentazione:**

Questo prodotto deve essere utilizzato entro i parametri di alimentazione indicati nei limiti per il prodotto, specificati in questo manuale."

**Smaltimento:**

L'unità contiene componenti che richiedono procedure speciali di smaltimento. Accertarsi che l'unità venga smaltita in modo corretto al termine della vita utile e nel rispetto delle normative locali.

**RISCHIO DI SCOSSA ELETTRICA****Avvertimento di alta tensione:**

All'interno dell'alimentatore sono presenti tensioni pericolose. Gli installatori professionali devono proteggere il personale di manutenzione dal rischio di contatto accidentale con queste tensioni pericolose all'interno dell'apparecchiatura finale.

**ATTENZIONE:** Se installato in un'attrezzatura di classe I, questo prodotto deve essere collegato a terra in modo

affidabile ed installato in modo professionale.

Le uscite (+) o (-) possono essere messa a terra o lasciate isolate.

I coperchi/il telaio dell'unità non devono essere accessibili da parte dell'utente.

Il connettore dell'alimentazione principale non può essere utilizzato come terminale di collegamento di campo. Non utilizzare viti che penetrano nell'unità per più di 3mm (FPS/RFE 1000), 6mm (HFE/RFE 1600/2500, racks). Per questi prodotti vengono usate viti speciali di messa a terra, che collegano il coperchio al telaio. Tali viti non devono essere rimosse. Se le viti vengono tolte per errore, vanno sostituite con nuove viti ed occorre testare il prodotto per verificarne il collegamento a massa. Questa unità deve essere fissata in modo saldo e la sua piastra di base deve aderire correttamente alla messa a terra protettiva di rete prima di procedere a qualsiasi collegamento all'alimentazione di rete a CA.

Un fusibile interno protegge l'unità e non deve essere sostituito dall'utente. Nell'eventualità di un difetto interno, restituire l'unità a TDK-Lambda o a uno dei suoi agenti autorizzati. L'apparecchiatura finale deve includere una recinzione meccanica, elettrica e antincendio per proteggere dai pericoli di natura meccanica, dalle scosse elettriche e dai pericoli di incendio.

### **Pericoli energetici:**

Alcuni moduli sono in grado di erogare energia pericolosa (240 VA) a seconda della tensione in uscita impostata. I produttori delle apparecchiature finali sono tenuti a proteggere il personale di manutenzione dal rischio di contatto accidentale con questi terminali dei moduli di uscita. Se impostati su livelli che non escludono l'erogazione di energia pericolosa, questi terminali o collegamenti non devono risultare accessibili

**Dispositivo di disattivazione:** un dispositivo di disattivazione appropriato sarà incorporato nell'impianto elettrico dell'edificio. Vedere il manuale utente del modello specifico per ulteriori informazioni.

### **Istruzioni di sicurezza del montaggio in rack:**

A) Ambiente di esercizio elevato - Se l'unità viene installata in un gruppo chiuso o in un rack con più unità, la temperatura ambiente di esercizio dell'ambiente rack potrebbe essere maggiore rispetto a quella della stanza. Di conseguenza, occorre prendere in considerazione l'installazione dell'apparecchiatura in un ambiente compatibile con la temperatura ambiente massima (T<sub>ma</sub>) specificata dal produttore.

B) Flusso d'aria ridotto - L'installazione dell'apparecchiatura in un rack deve essere tale da non compromettere la quantità di flusso d'aria necessaria per un funzionamento sicuro dell'apparecchiatura.

C) Carico meccanico - Il montaggio dell'apparecchiatura nel rack deve essere tale da non creare una condizione di pericolo a causa di un carico meccanico non omogeneo.

D) Sovraccarico del circuito - È necessario valutare il collegamento dell'apparecchiatura al circuito di alimentazione e l'effetto che il sovraccarico dei circuiti potrebbe avere sulla protezione da sovracorrente e il cablaggio di alimentazione. È necessario prendere in appropriata considerazione i valori nominali di targa dell'apparecchiatura quando si affronta questo problema.

E) Messa a terra sicura - Deve essere mantenuta una messa a terra sicura dell'apparecchiatura montata su rack. Deve essere prestata particolare attenzione alle connessioni di alimentazione diverse dalle connessioni dirette al circuito di derivazione (per esempio uso di prese multiple).



da parte dell'utente.

### **SUPERFICIE CALDA**

#### **Superfici esterne calde:**

Coerentemente con le norme locali in materia di salute & sicurezza professionali, i produttori sono tenuti a salvaguardare i tecnici di manutenzione, e inoltre gli utenti. Per far fronte a tali obblighi, i prodotti devono presentare una targhetta, chiaramente visibile al personale di manutenzione che accede all'apparecchiatura nel complesso e che risulti inoltre leggibile e avverta gli addetti del rischio che le superfici di questi prodotti possono scottare e non vanno toccate con i prodotti in funzione.

L'unità può essere installata in qualunque orientamento, ma non in posizione capovolta o in posizione verticale con il flusso dell'aria rivolto verso il basso. Le griglie di ventilazione su questi prodotti non devono essere ostruite. Verificare che vi sia una distanza minima di 50 mm fra le griglie di ventilazione e qualsiasi eventuale ostruzione.

Il coperchio/telaio dell'unità è realizzato per proteggere il personale esperto dai pericoli. Non deve essere usato come parte degli involucri esterni di qualsiasi apparecchiatura, se risulta accessibile da parte degli addetti, poiché è possibile che in condizioni di pieno carico una o più parti del telaio dell'unità giunga/giungano a temperature superiori ai limiti considerati sicuri per l'accesso da parte degli addetti.



**ESPAÑOL****Instrucciones generales de seguridad:****LEA LAS INSTRUCCIONES DE SEGURIDAD****Servicio:**

Estos productos no pueden ser reparados por los clientes. TDK-Lambda y sus agentes autorizados son los únicos que pueden llevar a cabo las reparaciones.

**Componentes fundamentales:**

Estos productos no pueden ser utilizados como componentes fundamentales en sistemas de control nuclear, sistemas de soporte vital o equipos a utilizar en entornos peligrosos sin el consentimiento expreso por escrito del Director General de TDK-Lambda EMEA.

**Uso de los productos:**

Estos productos han sido diseñados para ser utilizados en un equipo central que restrinja el acceso al personal cualificado autorizado.

Este producto es una fuente de alimentación y sólo puede ser instalado por personal cualificado dentro de otros equipos y no debe ser tratado como un producto independiente. Este producto debe ser vendido entre empresas profesionales y solo puede obtenerse a través de los canales de distribución. No está destinado para la venta a usuarios finales.

Este producto es una fuente de alimentación de componentes y cumple con la directiva EMC. El rendimiento de CEM del suministro eléctrico de un componente se verá afectado por la instalación final; el fabricante del equipo final debe confirmar el cumplimiento de las normas CEM establecidas y la conformidad con la Directiva CEM después de la instalación. Si desea orientación sobre las condiciones de prueba, visite nuestro sitio web en [https://emea.tdk-lambda.com/EMC\\_guidance](https://emea.tdk-lambda.com/EMC_guidance) o póngase en contacto con la oficina de ventas local de TDK-Lambda.

**Medioambiental:**

Estos productos son IPX0 y, por tanto, no pueden utilizarse sustancias químicas/disolventes, agentes de limpieza ni otros líquidos.

**Medio ambiente:**

Esta fuente de alimentación es una fuente de alimentación de modo conmutado a utilizar en aplicaciones dentro de un entorno con un Grado de contaminación 2 y una Categoría de sobretensión II. En él se utilizan policloruros de bifenilo del Grupo de materiales IIIb.

**Carga de salida:**

La potencia de salida tomada de la fuente de alimentación no puede sobrepasar el valor nominal indicado en la etiqueta de la fuente de alimentación, excepto en los casos indicados en las limitaciones del producto en este manual.

**Parámetros de entrada:**

Este producto debe ser utilizado dentro de los parámetros de entrada indicados en las limitaciones del producto en este manual.

**Desecho de la unidad:**

La unidad contiene componentes que deben ser desechados de una manera especial. Asegúrese de desechar correctamente la unidad al final de su vida útil y conforme a las normas locales vigentes.

**PELIGRO DE DESCARGAS ELÉCTRICAS****Advertencia de alta tensión:**

En esta fuente de alimentación hay tensiones peligrosas. El instalador profesional debe proteger al personal de servicio contra cualquier contacto accidental con estas tensiones peligrosas en el equipo final.

**ADVERTENCIA:** La instalación de este producto en un equipo de clase I la deben llevar a cabo profesionales y el producto debe estar conectado a tierra.

La salida o salidas (+) o (-) pueden conectarse a tierra o se las puede dejar flotando.

Debe impedirse el acceso de los usuarios a la cubierta o cubiertas y al chasis de la unidad.

El conector de entrada de la red no es apto para ser utilizado a modo de bornes de cableado de campo. No utilice tornillos de montaje susceptibles de penetrar en la unidad más de 3mm (FPS/RFE 1000), 6mm (HFE/ RFE 1600/2500, racks). Con estos productos se utilizan unos tornillos de puesta a tierra especiales que conectan la cubierta al chasis. No se deben quitar en ningún caso. En caso de quitarlos por error, hay que reemplazarlos por unos nuevos y comprobar la conexión a tierra del producto.

Esta unidad se debe montar de forma que quede firmemente aseguradas y su placa base quede bien conectada a la toma de tierra de protección principal antes de establecer cualquier conexión a la fuente de alimentación de CA de la red. Un fusible interno protege la unidad y este no debe ser nunca reemplazado por el usuario. En caso de existir algún defecto interno, la unidad debe ser enviada a TDK-Lambda o a uno de sus agentes autorizados. El equipo de uso final debe constituir un recinto de protección mecánica, eléctrica y contra incendios de protección mecánica, contra descargas eléctricas y contra el peligro de incendios.

### **Peligros de energía:**

Algunos módulos pueden generar energía peligrosa (240VA) dependiendo de la configuración de la tensión de salida. Los fabricantes de equipos finales deben proteger al personal de servicio contra un contacto accidental con estos bornes de salida de los módulos. Si se configura de modo que pueda generarse energía peligrosa, hay que evitar que el usuario pueda acceder a los bornes o conexiones del módulo.

**Dispositivo de desconexión:** Se debe incorporar un dispositivo de desconexión apropiado en el cableado de instalación del edificio. Consulte el manual de usuario del modelo específico para obtener más detalles.

### **Instrucciones de seguridad para el montaje en bastidor:**

A) Temperatura Ambiente de Funcionamiento Elevada - si se instala en un conjunto de bastidor cerrado o de unidades múltiples, la temperatura ambiente de funcionamiento del entorno del bastidor puede ser mayor que la temperatura ambiente de la habitación. Por lo tanto, se debe considerar instalar el equipo en un entorno compatible con la temperatura ambiente máxima (T<sub>ma</sub>) especificada por el fabricante.

B) Flujo de Aire Reducido - la instalación del equipo en un bastidor debe ser tal que la cantidad de flujo de aire requerida para el funcionamiento seguro del equipo no se vea comprometida.

C) Carga Mecánica - el montaje del equipo en el bastidor debe prevenir que se produzca una condición peligrosa debido a una carga mecánica desigual.

D) Sobrecarga del Circuito - se debe considerar la conexión del equipo al circuito de alimentación y el efecto que la sobrecarga de los circuitos podría tener sobre la protección contra sobrecorriente y sobre el cableado de alimentación. Al abordar este asunto, debe tenerse muy en cuenta los valores de consumo definidos en la placa de identificación del equipo.

E) Conexión a Tierra Confiable - se debe mantener una conexión a tierra confiable del equipo montado en bastidor. Se debe prestar especial atención a las conexiones de alimentación que no sean conexiones directas al circuito derivado (por ejemplo, uso de regletas de enchufes).



## **SUPERFICIE CALIENTE**

### **Superficies externas calientes:**

Según las normas locales relativas a la Salud y Seguridad en el trabajo, los fabricantes están obligados a proteger a los ingenieros de servicio además de a los usuarios. Para que esto se cumpla, debe colocarse una etiqueta en estos productos que pueda ser vista claramente por el personal de servicio que accede al equipo general, y con advertencias legibles de que las superficies de estos productos pueden estar calientes y no deben tocarse cuando los productos se encuentran en funcionamiento.

La unidad se puede montar en cualquier orientación excepto invertida (montada sobre su parte de arriba) o vertical con los orificios para el flujo de aire mirando hacia abajo. Las aberturas de ventilación de estos productos no deben obstruirse jamás. Asegúrese de que quede una separación de 50 mm por lo menos entre cualquier obstrucción y las aberturas de ventilación.

La cubierta/chasis de la unidad ha sido diseñada para que proteja a las personas cualificadas de los peligros. No deben ser utilizadas como parte de las cubiertas externas de cualquier equipo al que pueden acceder los operarios, ya que bajo unas condiciones de carga completa, la pieza o piezas del chasis de la unidad pueden alcanzar temperaturas superiores a las consideradas seguras para el acceso de los operarios.

**PORTUGUÊS****Instruções gerais de segurança:****LEIA AS INSTRUÇÕES DE SEGURANÇA****Manutenção:**

Estes produtos não são podem ser submetidos a manutenção por parte do cliente. Apenas a TDK-Lambda e os seus agentes autorizados têm permissão para realizar reparações.

**Componentes essenciais:**

Não é autorizada a utilização destes produtos como componentes essenciais de sistemas de controlo nuclear, sistemas de suporte de vida ou equipamento para utilização em ambientes perigosos sem a expressa autorização por escrito do Director-Geral da TDK-Lambda EMEA.

**Utilização do produto:**

Estes produtos foram concebidos para utilização dentro de um equipamento de alojamento que apenas permita o acesso a pessoal qualificado autorizado.

Este produto é uma alimentação considerado com um componente para ser instalado por pessoas qualificadas, em outros equipamentos. Não deve ser usado como um produto acabado.

Este produto é destinado para venda entre as empresas e pode ser obtido através de canais de distribuição. Não se destina à venda aos particulares

Este produto é uma fonte de alimentação componente e está em conformidade com a directiva EMC.

O desempenho EMC da fonte de alimentação de um componente será afetado pela instalação final. Após a instalação, o fabricante do equipamento final tem de confirmar a conformidade com as normas EMC indicadas e a conformidade com a Directiva EMC. Para obter orientação relativamente às condições de teste, visite o nosso website, em [https://emea.tdk-lambda.com/EMC\\_guidance](https://emea.tdk-lambda.com/EMC_guidance), ou contacte o seu escritório de vendas local da TDK-Lambda.

**Ambiental:**

Estes produtos são IPX0 e, como tal, não se devem utilizar químicos/solventes, agentes de limpeza e outros líquidos.

**Ambiente:**

Esta fonte de alimentação é uma fonte de alimentação do modo de comutação para utilização em aplicações com um Nível de Poluição 2 e ambientes da categoria de sobretensão II. São utilizadas placas de circuitos impressos do grupo de materiais IIIb.

**Carga de saída:**

A potência de saída extraída da fonte de alimentação não deve exceder a classificação assinalada na etiqueta da fonte de alimentação, excepto quando indicado nas limitações do produto neste guia.

**Parâmetros de entrada:**

Este produto deve ser utilizado dentro dos parâmetros de entrada indicados nas limitações do produto neste guia.

**Eliminação no fim de vida:**

A unidade contém componentes que necessitam de procedimentos especiais de eliminação. Certifique-se de que a unidade é devidamente eliminada no fim da sua vida útil e que tal é feito em conformidade com os regulamentos locais.

**RISCO DE CHOQUE ELÉCTRICO****Aviso de alta tensão:**

Estão presentes tensões perigosas dentro da fonte de alimentação. O profissional que realizar a instalação deve proteger o pessoal de assistência contra contactos inadvertidos com estas tensões perigosas do equipamento final.

**AVISO:** Quando instalado num equipamento de Classe I, este produto deve ser ligado à terra de forma fiável e instalado por um profissional.

As saídas (+) e (-) podem ser ligadas à terra ou deixadas soltas.

O chassis/cobertura(s) da unidade não deve estar acessível ao utilizador.

O conector de entrada de alimentação não deve ser utilizado como terminal de cablagens no local. Não utilize parafusos de montagem, uma vez que estes penetrarão na unidade em mais do que 3mm (FPS/RFE 1000), 6mm (HFE/RFE 1600/2500, racks). Nestes produtos utilizam-se parafusos especiais de ligação à terra, que ligam a cobertura ao chassis. Não devem ser removidos. Se forem removidos por engano, deverão ser substituídos por parafusos novos, devendo-se testar a ligação à terra do produto.

A unidade deve ser instalada de forma segura e o seu suporte devidamente ligado à principal terra de protecção antes de se realizar qualquer ligação à fonte de alimentação de corrente alternada. Existe um fusível interno que protege a unidade e que não deve ser substituído pelo utilizador. Em caso de defeito interno, a unidade deve ser devolvida à TDK-Lambda ou a um dos seus agentes autorizados. O equipamento de utilização final deve fornecer um bastidor com protecção mecânica, eléctrica e contra incêndios adequada.

### **Perigos de energia:**

Alguns módulos tem a capacidade de fornecer energia perigosa (240 VA), de acordo com a configuração da tensão de saída. O equipamento final do fabricante deve garantir que o pessoal de assistência está protegido contra contactos inadvertidos com estes terminais de saída do módulo. Se essa energia perigosa for produzida, as ligações e os terminais do módulo não devem ser acessíveis pelos utilizadores.

**Desligar o dispositivo:** Na instalação da cablagem do edifício será incorporado um dispositivo para desligar. Consulte o manual do utilizador do modelo específico para obter mais detalhes.

### **Instruções de segurança para a montagem do bastidor:**

A) Ambiente de Operação Elevado – se o bastidor for instalado num local fechado ou com várias unidades, a temperatura ambiente de operação do bastidor deverá ser superior à temperatura ambiente do local. Por tal motivo, importa ter em conta que o bastidor deverá ser instalado num ambiente compatível com a temperatura ambiente máxima (T<sub>ma</sub>) especificada pelo fabricante.

B) Fluxo de Ar reduzido – A instalação do equipamento num bastidor deverá ser de forma a não comprometer a quantidade de ar necessária para o funcionamento seguro do mesmo.

C) Carga Mecânica – A montagem do equipamento no bastidor deverá ser de forma a evitar desequilíbrios de cargas mecânicas.

D) Sobrecarga do Circuito – Deverá ser tida em consideração a conexão do equipamento ao circuito de alimentação e o efeito que a sobrecarga dos circuitos possa ter na protecção de sobretensão e cablagem de alimentação. Deve ter-se em atenção as informações constantes na placa sinalética do equipamento, quando se abordar esta questão.

E) Ligação de Terra Fiável – Deve ser mantida uma ligação de terra fiável para o equipamento montado no bastidor. Deverá ser dada atenção particular às ligações de alimentação e não só às ligações directas ao circuito derivado (por exemplo utilização de réguas de extensão).



## **SUPERFÍCIE QUENTE**

### **Superfícies quentes externas:**

Segundo com os regulamentos locais sobre saúde e segurança no local de trabalho, os fabricantes têm a obrigação de proteger os técnicos de manutenção, bem como os utilizadores. De forma a respeitar este regulamento, estes produtos deverão ter uma etiqueta que seja facilmente visível ao pessoal de assistência que aceda ao equipamento em geral, e que alerte, de forma legível, para o facto de as superfícies destes produtos poderem estar quentes, não devendo ser tocadas quando os produtos estão em funcionamento.

A unidade pode ser instalada em qualquer posição, excepto invertida (montada sobre a parte superior), ou na posição vertical, com o fluxo de ar dirigindo-se para baixo. As aberturas de ventilação destes produtos não devem ser obstruídas. Certifique-se de que existe um espaçamento de pelo menos 50 mm entre qualquer obstrução e as aberturas de ventilação.

O chassis/cobertura da unidade está concebido de forma a proteger o pessoal especializado de perigos. Não devem ser utilizados como parte das coberturas externas de qualquer equipamento em que possam estar acessíveis aos operadores, uma vez que em condições de carga máxima, algumas peças do chassis da unidade podem atingir temperaturas superiores às consideradas seguras para o acesso do operador.

**USER MANUAL**  
**LAN Interface**  
**For**  
**HFE POWER SUPPLIES**  
**with**  
**PMBUS Option (/S)**

Manual Supplement

Refer to HFE1600/2500 and HFE1600/2500-S1U Instruction Manual for installing the power supplies, safety requirements and specifications.

## Table of Content

<b>1. GENERAL INFORMATION .....</b>	<b>4</b>
1.1 Introduction .....	4
1.2 Feature Summary .....	4
1.3 Front Panel View .....	8
<b>2. SPECIFICATIONS.....</b>	<b>10</b>
<b>3. CONNECT TO NETWORK .....</b>	<b>13</b>
3.1 LAN Cable.....	13
3.2 Type of Networks .....	13
3.3 Power-up the LAN Module .....	14
3.4 IP Address.....	14
3.5 Hostname.....	15
<b>4. LAN SETUP .....</b>	<b>16</b>
4.1 View the IP and MAC Addresses .....	16
4.2 LAN Reset .....	16
<b>5. WEB PAGES .....</b>	<b>17</b>
5.1 Benefit of Web Pages .....	17
5.2 Opening the HOME Page .....	17
5.3 The HOME Page .....	18
5.4 DC Power Page.....	19
5.5 LAN Page .....	24
<b>6. PROGRAMMING USING VISA DRIVERS .....</b>	<b>30</b>
6.1 VISA Description.....	30
6.2 VXI-11 Compatibility .....	30
6.3 Opening the VISA Connection .....	30
6.4 Communicating Using VISA .....	30
<b>7. PROGRAMMING USING SOCKETS.....</b>	<b>31</b>
7.1 Socket Description.....	31
7.2 Communicating Using Sockets .....	31
7.3 Controller Access: Single and Multiple Clients .....	31
7.4 Input Buffer Requirements .....	32
7.5 Message Terminators .....	32
7.6 Using TCP Sockets .....	32
7.7 Using UDP Sockets .....	32

<b>8. COMMAND SET.....</b>	<b>33</b>
8.1 Selecting an Individual Power Supply .....	33
8.2 Selecting a Group of Power Supplies.....	33
8.3 Output On/Off.....	33
8.4 Clear Faults .....	33
8.5 Programming the Output Voltage .....	34
8.6 Programming the Current Limit (HFE2500/S only) .....	34
8.7 Programming the Maximum allowed Programmable Output Voltage.....	34
8.8 Output Voltage Monitoring .....	35
8.9 Output Current Monitoring .....	35
8.10 Temperature Monitoring.....	35
8.11 Read Faults.....	35
8.12 Enabling / Disabling the Monitoring Filter .....	36
8.13 Programming and Monitoring Coefficients .....	36
8.14 Inventory Details of the Power Supply.....	36
8.15 Inventory Details of the LAN Module .....	37
8.16 LAN Specific Commands .....	37
8.17 Scan for Active Power Supplies.....	37
<b>9. TROUBLESHOOTING .....</b>	<b>38</b>

## 1. GENERAL INFORMATION

### 1.1 Introduction

The Local Area Network (LAN) option for the HFE series power supply allows the user to remotely program, measure and check status of the power supplies.

The LAN option is designed to communicate with single or multiple supplies in a rack or with multiple racks housing HFE power supplies.

The LAN option is also designed to communicate with multiple racks, each rack holding either HFE1600/S or HFE2500/S power supplies with PMBUS option.

The user can install and remove the HFE LAN module with no disruption to the operation of the HFE power supplies.

A computer's web page browser can be used to operate the module through a built-in web page server. For applications including factory and test automation, communication may be done using several standard network protocols and instrument commands.

### 1.2 Feature Summary

**\*Communicate** over standard TCP/IP networks

- a. LAN (Local Area Network)
- b. WAN (Wide Area Network)
- c. Communicate across the world using the Internet

**\*Web page** viewable with web page browsers, such as Internet Explorer

- d. Configure the network connection settings
- e. Graphical user Interface (GUI) that programs and reads the power supply output and status.
- f. Security settings to block multiple controllers and risky protocols.
- g. Optional password protection prevents unauthorized operation.

**\*LAN Protocols**

- h. VISA drivers, Telnet, TCP and UDP sockets are supported.
- i. VXI-11 Discovery and ping server are supported.
- j. SNMP is supported.
- k. Easily write custom automation programs.

**\*Full remote programming functions**

- l. Compatible with VISA drivers and all the test & measurement utilities.
- m. TCP and UDP sockets will support PLCs, Linux and other non-VISA controllers.

**\*Front Panel features**

- n. Ethernet RJ-45 connector.
- o. LAN Reset button.
- p. User may remotely "blink" the front panel to locate the LAN module.
- q. Link and Activity LED on RJ-45 connector.
- r. LAN Status LED's.

**\*I2C Multi-drop Chain**

- s. Allows connecting up to 16 power supplies (or housing of 2 racks of HFE1600-S1U/TB or HFE2500-S1U/TB).
- t. One LAN IP address shared by all power supplies.
- u. Support up to 9 HFE1600/S or 7 HFE2500/S power supplies in 2 racks.



HFE 1600 LAN Outline Drawing

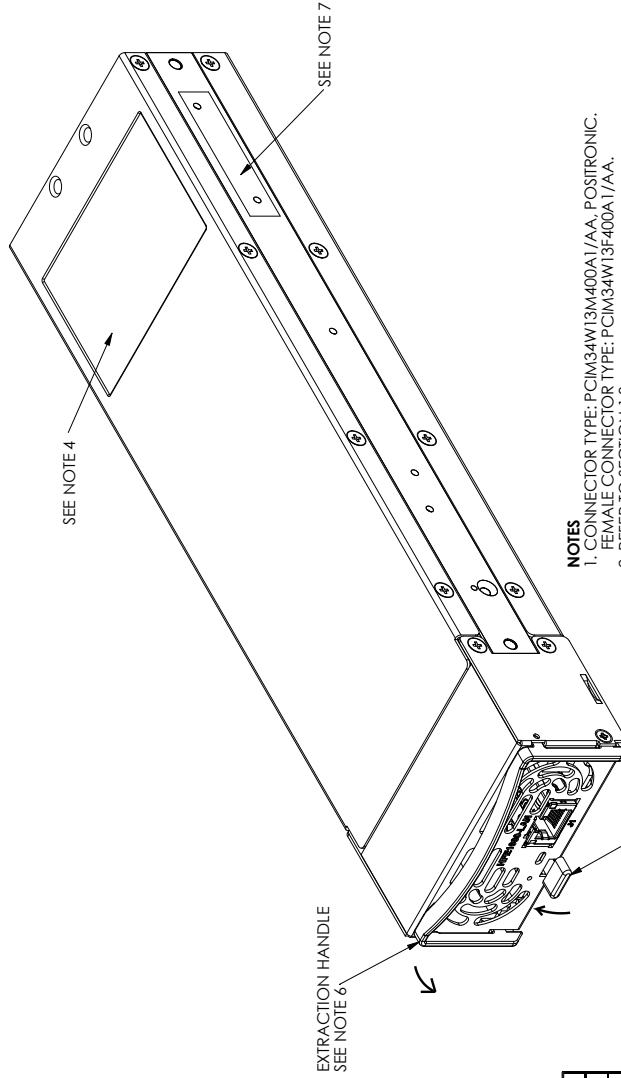
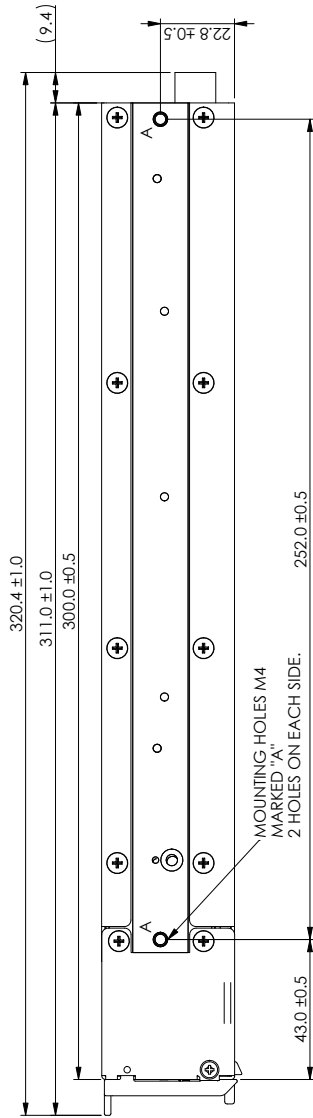

- NOTES**
1. CONNECTOR TYPE: PCIM34W13M400A1/AA, POSITRONIC. FEMALE CONNECTOR TYPE: PCIM34W13F400A1/AA.
  2. REFER TO SECTION 1.3.
  3. MOUNTING SCREWS MUST NOT PENETRATE MORE THAN 7mm INTO THE UNIT.
  4. MODEL NAME, INPUT RATING AND SAFETY APPROVAL SYMBOLS ARE DESCRIBED ON TOP SURFACE LABEL.
  5. ALLOW MINIMUM 50 mm OF UNRESTRICTED AIR SPACE AT THE REAR OF UNIT. DO NOT OBSTRUCT AIR FLOW TO THE UNIT FRONT PANEL.
  6. TO EXTRACT THE MODULE, ELEVATE AND HOLD THE RELEASE KNOB AND PULL THE EXTRACTION HANDLE.
  7. EU REPRESENTATIVE ADDRESS LABEL.

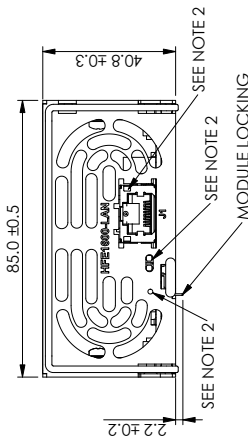

REAR VIEW

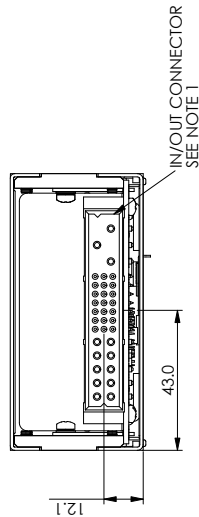

IN/OUT CONNECTOR REAR VIEW

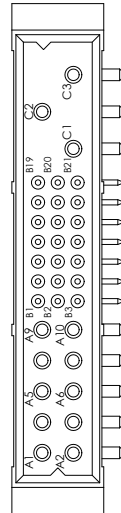

PIN No	FUNCTION	PIN No	FUNCTION
A1 ~ A5	NC	B12	NC
A6 ~ A10	NC	B13	SCL (SERIAL CLOCK)
B1	SIGNAL RETURN	B14	NC
B2	MODULE EXIST	B15	NC
B3	+12V_AUX_IN	B16	NC
B4	NC	B17	SDA (SERIAL DATA)
B5	NC	B18	NC
B6	NC	B19	NC
B7	NC	B20	SMB_ALERT
B8	NC	B21	NC
B9	NC	C1	NC
B10	NC	C2	NC
B11	NC	C3	NC

**HFE 2500 LAN Outline Drawing**

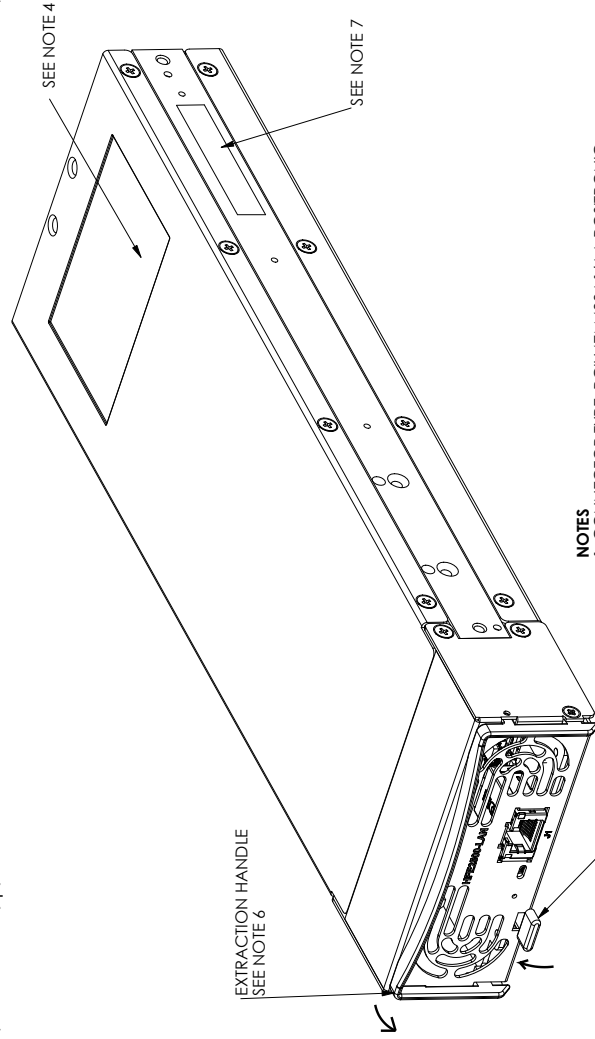
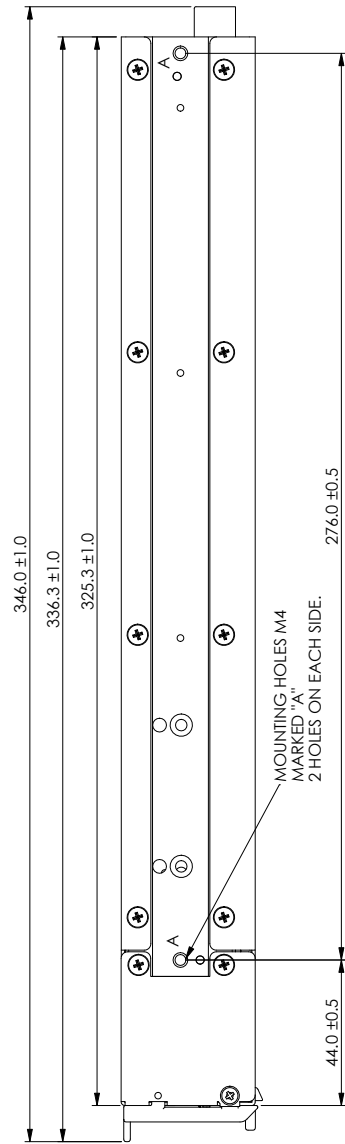

- NOTES**
1. CONNECTOR TYPE: PCIH47M400A1/AA, POSITRONIC, MATES WITH FEMALE CONNECTOR TYPE: PCIH47F400A1/AA.
  2. REFER TO SECTION 1.3.
  3. MOUNTING SCREWS MUST NOT PENETRATE MORE THAN 7mm INTO THE UNIT.
  4. MODEL NAME, INPUT RATING AND SAFETY APPROVAL SYMBOLS ARE DESCRIBED ON TOP SURFACE LABEL.
  5. ALLOW MINIMUM 50 mm OF UNRESTRICTED AIR SPACE AT THE REAR OF UNIT. DO NOT OBSTRUCT AIR FLOW TO THE UNIT FRONT PANEL.
  6. TO EXTRACT THE MODULE, ELEVATE AND HOLD THE RELEASE KNOB AND PULL THE EXTRACTION HANDLE.
  7. EU REPRESENTATIVE ADDRESS LABEL.

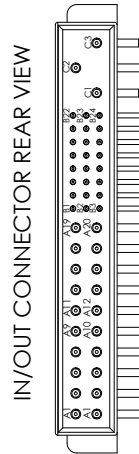
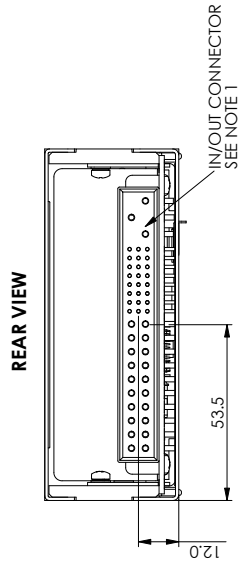
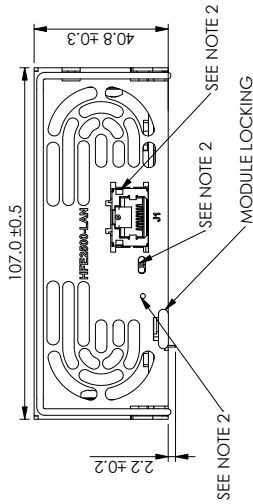

PIN No.	FUNCTION	PIN No.	FUNCTION
A1-A10	NC	B14	NC
A11-20	NC	B15	NC
B1	SIGNAL RETURN	B16	NC
B2	MODULE EXST	B17	SDA (SERIAL DATA)
B3	+12V AUX IN	B18	NC
B4	NC	B19	NC
B5	NC	B20	SMB ALERT
B6	NC	B21	NC
B7	NC	B22	NC
B8	NC	B23	NC
B9	NC	B24	NC
B10	NC	C1	NC
B11	NC	C2	NC
B12	NC	C3	NC
B13	SCL (SERIAL CLOCK)		

## IN / OUT Connector Pin Assignment

### HFE 1600 - LAN

Connector Position	Signal Names	Description
B1	SIGNAL RETURN	Return for PMBus signals: SCL, SDA, SMB ALERT
B2	MODULE EXIST	Indicates that module is inserted into the shelf. "Active low" when connected to SIGNAL RETURN
B3	+12V AUX IN	<b>12V DC Input</b> referenced to SIGNAL RETURN. (11.2 ~ 12.5V, 500mA max)
B13	SCL	Serial Clock signal
B17	SDA	Serial Data signal
B20	SMB ALERT	PMBus INTERRUPT Signal

*Table 1. HFE 1600-LAN Pin Assignment*

**Note - If HFE LAN module is installed in the rack, +12V\_AUX (pin 38 of J1 connector on HFE/S1U rack) cannot be used as an auxiliary supply.**

### HFE 2500 - LAN

Connector Position	Signal Names	Description
B1	SIGNAL RETURN	Return for PMBus signals: SCL, SDA, SMB ALERT
B2	MODULE EXIST	Indicates that module is inserted into the shelf. "Active low" when connected to SIGNAL RETURN
B3	+12V AUX IN	<b>12V DC Input</b> referenced to SIGNAL RETURN. (11.2 ~ 12.5V, 500mA max)
B13	SCL	Serial Clock signal
B17	SDA	Serial Data signal
B20	SMB ALERT	PMBus INTERRUPT Signal

*Table 2. HFE 2500-LAN Pin Assignment*

**Note - If HFE LAN module is installed in the rack, +12V\_AUX (pin 38 of J1 connector on HFE/S1U rack) cannot be used as an auxiliary supply.**

### 1.3 Front Panel View

The module front panel, is shown below.

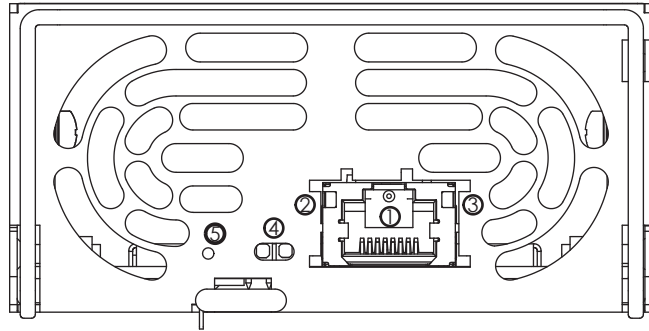

**Figure 1. LAN Front Panel**

1. **LAN Connector:** RJ45, 8 pin, 10/100MBps and IEEE802.3 compliant.
2. **Link/Activity LED:** This LED, embedded in the RJ-45 socket, glows green and blinks when the connection is made to an active network and packets are being transmitted.
3. **Speed LED:** This Amber LED is ON at speed of 100MBps and OFF at speed of 10MBps.
4. **LAN Status LED:** There are two LED's next to the RJ-45 connector. It shows:
  - **Normal Operation: Steady green.** The module has an active LAN connection
  - **Device Identify: Blinking green.** The identify function is turned on from a remote computer using the web page or with command. It is used to identify one LAN module in a rack of instruments. The led will also blink if there is a duplicate IP. The blinking is turned off by the web page or by sending a LAN specific command.
  - **LAN Fault: Steady red.** Shows the LAN mode is not enabled, the LAN connection was never made, or that the LAN connection was made and then broken.
5. **Reset Switch:** This switch resets the LAN to its default settings.

## Safety Approvals

### 1. Specification

Applicable safety standards	IEC 62368-1 UL62368-1 CSA22.2 No.62368-1 EN62368-1.	
Withstand voltage	I/O connector AC pins C2, C3 - Ground	2000VAC/2828VDC
	I/O connector AC pins C2, C3 - LAN/ Rear connector	3000VAC/4242VDC
	LAN/Rear connector - Ground	500VAC/707VDC

### 2. Safety Approvals

UL62368-1 and CSA22.2 No.62368-1 - UL Recognized. C-UL for Canada

IEC 62368-1 - CB Test Report and Certificate.

EN 62368-1 - TUV Mark, CE Mark.

Marking of the CE symbol indicates compliance to the EMC Directive, and the Low Voltage Directive and RoHS Directive of the European Union.

A "Declaration of Conformity" in accordance with the preceding directives and standards has been made and is on file at our EU representative: TDK-Lambda Germany GmbH, Karl-Bold-Str. 40, D-77855 Achern. A "Declaration of Conformity" may be accessed via company website [www.emea.tdk-lambda.com/manual](http://www.emea.tdk-lambda.com/manual)

### SAFETY INSTRUCTIONS

**CAUTION:** The following safety precaution must be observed during all phases of operation, service and repair of this equipment. Failure to comply with the safety precautions or warnings in this document violates safety standards of design, manufacture and intended use of this equipment and may impair the built-in protections within. TDK Lambda shall not be liable for user's failure to comply with these requirements.

**CAUTION:** HFE1600/2500-LAN unit is not authorized for use as critical component in nuclear control systems, life support systems or equipment for use in hazardous environments without the express written approval of the managing director of TDK-Lambda.

### ENVIRONMENTAL CONDITIONS

HFE1600/2500-LAN unit intended for use under following environments:

- \*Indoor use
- \* Pollution degree 2
- \* Max. operational altitude: 3000m above sea level
- \*Ambient temperature: -10°C ~ +70°C.

### PARTS SUBSTITUTIONS & MODIFICATIONS

Parts substitutions and modifications are authorized TDK Lambda service personnel only. For repairs or modifications, the instrument must be returned to TDK Lambda service facility.

**2. SPECIFICATIONS**

<p><b>2.1 GENERAL</b></p> <p>When using the HFE LAN, the ratings and accuracies are the same as for the programming and monitoring using PMBUS. Refer to the Instruction Manual for HFE power supply (/S option) for the specifications and calculations.</p>	
<p><b>2.2 ELECTRICAL</b></p> <p>Ethernet Auto-MDIX Auto-Negotiate</p>	<p>Meets IEEE 802.3u specifications Accepts patch or cross-over cable connection Selects fastest of 10Base-T or 100Base-T networks (10 or 100 Megabits per second)</p>
<p><b>2.3 NETWORK CONFIGURATION</b></p> <p>MAC Address</p> <p>IP Address</p> <p>DHCP Auto-IP</p> <p>Static IP Hostname Duplicate IP Detection Subnet Mask Default Gateway DNS Server LAN Reset</p>	<p>TDK-Lambda is assigned: 00:19:f9:xx:xx:xx xx:xx:xx is the unique address for each unit Can be detected with discovery tool Discovery tool is available on <a href="http://www.lxistandard.org/About/LXI-Discovery-Tools.aspx">http://www.lxistandard.org/About/LXI-Discovery-Tools.aspx</a> IP can be changed via the Web Page or via SNMP Get address from network server, leasing services. Create own IP address: 169.254.xxx.xxx xxx.xxx is created by the module. Any IP fixed by the operator. NetBIOS. Operator settable name. Reject duplicate setting. Mask set by DHCP or static Address set by DHCP or static Address set by DHCP Reset configuration by front panel or a command</p>
<p><b>2.4 LAN PROTOCOLS</b></p> <p>TCP IPv4 Instrument Protocols: VXI-11 VISA TCP Sockets UDP Sockets VXI-11 Discovery Ping Server HTTP SNMP</p>	<p>LAN packets follow Transmission Control Protocol Internet Protocol version 4</p> <p>Supports Core channel, not Abort or Interrupt channels VXI-11 compliant, uses RPC and Port mapper. Send commands to port 8003 Send commands to port 8005 Find connected instruments Verify LAN connection to instrument Web page server with Java scripts. Collects and manages information of devices connected to the network.</p>
<p><b>2.5 COMMANDS</b></p>	<p>Control, Measurement and Status (Refer to Section 8 for the full set)</p>

<p><b>2.6 WEB PAGES</b>                  Multiple users                  Identity                  LAN Configuration                  Active Control GUI                  Send Commands</p>	<p>Maximum 2 web pages can be open at once                  Identify power supply model, serial number, revision etc.                  View and set LAN configuration                  Program and read output settings                  Send commands, read errors</p>
<p><b>2.7 INDICATORS</b>                  Speed LED                   Activity LED                  LAN Status LED                  Blink Identify</p>	<p>Indicates the speed at which the communication is running.                  Lit –100MBps.                  Non Lit - 10MBps.                  Indicates when LAN packets are detected.                  Red/green, indicates module has valid IP connection                  Find the LAN Module by remotely blinking the front panel LED</p>
<p><b>2.8 SWITCHES</b>                  LAN Reset</p>	<p>Reset LAN settings via front panel</p>
<p><b>2.9 SECURITY</b>                  Web Page Password                   Single Client Only                  Block UDP Sockets                  Disable VXI-11 Discovery                  Disable Ping Server</p>	<p>Can set password to prevent unauthorized or accidental changes to LAN module settings or suply settings                  Set to prevent multiple programs from taking control                  Single client will block attacks through UDP sockets                  Stop intruders from finding the module                  Stop intruders from finding the module</p>

**COMPLIANCE**

1	Operating Temperature	-10 ~ +70C
2	Storage Temperature	-30 ~ +85C
3	Operating Humidity	10~90% RH, no condensation
4	Storage Humidity	10~95% RH, no condensation
5	Vibration	Built to meet IEC60068-2-64(Basic Transportation)
6	Shock	Built to meet IEC60068-2-27(Basic Transportation)
7	Immunity	Built to meet IEC61000-4-2(Level 2,3), -3(Level 2), -4(Level 2),
		-5 (Level 3,4), -6(Level 2), -8(Level 4), -11
8	Weight	Max 0.8 Kg
9	Size (W*H*D)	HFE1600 - 85 x 41 x 300mm
		HFE2500 - 107 x 41 x 325mm

**Table 3. Compliance**

Specifications 5,6,7 in Table 3 are relevant only if the LAN module is installed in HFE1600/2500-S1U racks

**2.10 LAN Command Speed**

The following communication speeds are typical values only. In addition to the variability in the LAN interface, there are timing variations within the controller and the network routing.

**VISA Drivers Speed**

Commands and queries sent using VISA drivers generally take 10 mSec longer than the same message sent using TCP sockets.

**TCP Sockets Speed**

Typical Command or query speeds:

**System Queries** ~ 40mSec

Examples:

MEAS:VOLT?  
MEAS:CURR?  
MEAS:TEMP?

**Instrument Select for Multi-drop** ~ 40mSec

Example:

INST:NSEL?



### 3. CONNECT TO NETWORK

#### 3.1 LAN Cable

The LAN cable must be supplied by the customer. It may be a standard straight “patch” CAT-5 (or better) network cable or it may be a “crossover” cable where the pins are reversed on one end. The cable type is auto-detected by the module.

#### 3.2 Types of Networks

There are basically two types of networks that are discussed here:

1. **NETWORK WITH A SERVER:** this is the typical local area network with a computer acting as a server and network administrator to keep it running. The server will assign the IP address and other settings to the LAN module.

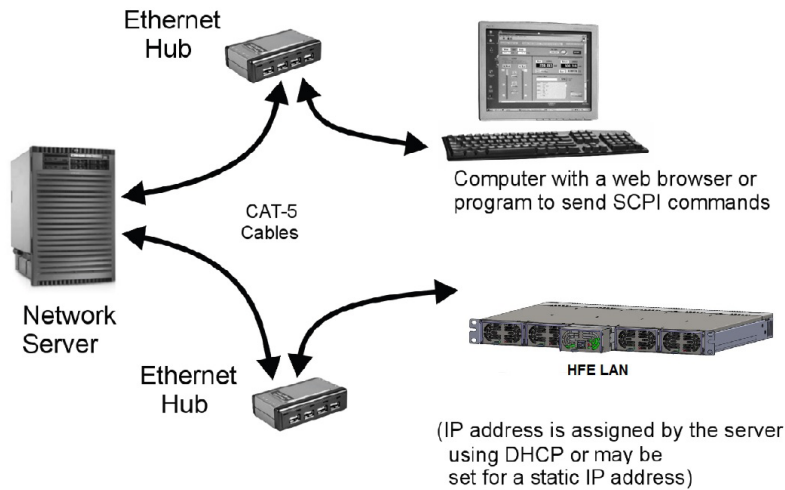

Figure 2. Server Network Connection

2. **PEER-TO-PEER NETWORK:** this is typically the situation when connecting the LAN module directly to a computer that is not a network server. The LAN module will configure its own IP address and settings.

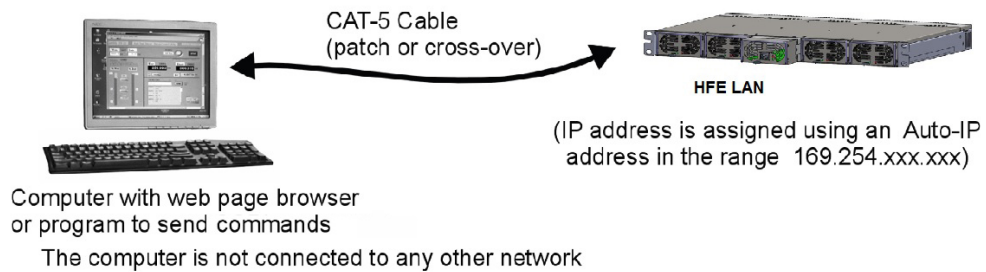

Figure 3. Peer-to-Peer Connection

**3.3 Power-up the LAN Module**

The LAN module will automatically detect if it is connected to or disconnected from a network. It will also automatically look for a network server and receive or create an IP address. It will also broadcast its IP address and hostname to all other devices on the network.

1. Insert the module into any slot of the HFE rack. The front panel LAN status LED will initially be red.
2. The LAN cable may be connected before or after the module is inserted.
3. **For a server network, wait about 10 seconds.**  
See that the front panel LAN Status LED turns green.
4. **For a peer-to-peer network, wait about 60-90 seconds.**  
See that the front panel LAN Status LED turns green.

When the LAN Status LED turns green, the module has received an IP address. Run the discovery tool to check the IP address received by the module. If the LAN Status LED does not turn green, see troubleshooting section.

*Note – There should be at least one HFE supply in the rack for the module to operate.*

**3.4 IP Address**

The simplest and most reliable way to open a network connection is using the module’s IP address. This is a group of four numbers separated by periods (for example: 10.1.15.123). This IP address may be viewed by running the discovery tool.

There are three modes by which the module can get an IP address, as show in this table:

<b>IP Address</b>	<b>DHCP</b>	<b>Auto-IP</b>	<b>Static IP</b>
<b>Mode Select</b>	DHCP is default after “LAN Reset”	Default after “LAN Reset” if no DHCP server is used	May be set in the “LAN Modify” web page (see section 5.5.2) or by SNMP.
<b>Assignment</b>	Assigned by the network server	Assigned by the LAN module.	Assigned in the “LAN Modify” web page (see section 5.5.2) or by SNMP.
<b>Range</b>	Any address	169.254.xxx.xxx	Any address
<b>Lifetime</b>	Address may change as the DHCP server assigns addresses dynamically to many instruments	Address may change for the LAN module	Fixed for the LAN module
<b>Duplicate Addresses</b>	The DHCP server should prevent duplicate IP addresses	Finds available auto-IP address	Returns to original IP (before change), LAN Status LED blinks. If duplicate IP is detected at AC ON, the IP defaults to DHCP or Auto-IP, LAN Status LED blinks.

*Table 4: Assignment of IP address by different Protocols*

### 3.5 Hostname

The hostname is an address in the form of text instead of numbers (for example: HFE-LAN-222). In order to work with the Hostname, a naming service (such as NetBIOS) must be running in the LAN computer.

A custom hostname can be created through the web page (see section 5.5.2) or SNMP. For example, if the hostname is changed to "TDK-LAMBDA", a control program can send a command to "TDK-LAMBDA".

The Hostname can be up to 15 characters. First character must be a letter. Last character must be a letter or digit. Intervening characters must be either a letter, digit or hyphen. After a "LAN Reset", the module will create a default hostname based on the model and serial number of the module.

The default hostname is in the following format:

HFE-LAN – < last 3 digits of serial number >

<b>Hostname</b>	<b>DHCP, Auto and Static IP</b>
<b>Default Hostname</b>	HFE-LAN-nnn
<b>Hostname Protocol</b>	Hostname by NetBIOS
<b>Hostname on Web Pages</b>	Shows Host name on "Home" page and "LAN Configure" page

*Table 5 – Host Name format in different Protocols*

## **4. LAN SETUP**

### **4.1 View the IP and MAC Addresses**

When the module is running, the IP and MAC addresses can be viewed by following these steps:

#### **To view the IP address-**

1. Run the discovery tool. It will detect the module and show its IP Address, Manufacturer Name, Serial Number and Firmware Revision. IP address can also be seen on the "Home" page via a web browser and be read via a LAN specific command

#### **To view the MAC address-**

1. There is a label on the cover of the module indicating the MAC address.
2. MAC address can also be seen on the "Home" page via a Web browser and can be read via a LAN specific command.

### **4.2 LAN Reset**

LAN reset can be done via a LAN specific command or via the front panel reset switch.

The default LAN settings are:

- o DHCP enabled
- o If DHCP fails to get a lease, auto-IP settings will be obtained.
- o Hostname: HFE-LAN-last 3 digits of Serial Number.
- o Description: TDK-LAMBDA HFE-LAN Last 3 digits of Serial Number.
- o Controller Access One Client Only
- o Ping Server: Enabled
- o Keep-Alive 1800 Seconds (30 minutes)
- o Auto-Negotiate: Automatically select network speed
- o VXI-11 Discovery: Enabled
- o Password: None
- o mDNS: Enabled
- o DNS-SD: Enabled

## 5. WEB PAGES

*Note – All figures in the web page section are examples only.*

### 5.1 Benefit of Web Pages

The HFE LAN web pages are useful for:

- Reading the module's model name, revision and LAN setup information
- Configuring the LAN connection
- Programming and reading the Power Supplies condition and reading the inventory details

### 5.2 Opening the HOME Page

Once the front panel LAN Status LED has turned green (see Section 1.3), you may open the HFE LAN web page.

1. Read the IP address of the module (see section 4.1)
2. Open a web page browser program such as Internet Explorer or Chrome. Type the module's IP address as shown below.

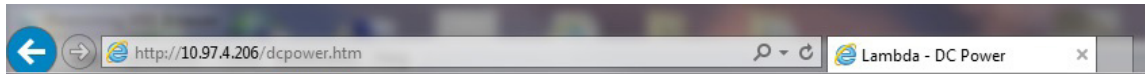

The module's Home page will appear. If it does not, see Troubleshooting section.

3. Alternately, the hostname may be used for addressing the web page as shown below (if the module is set for "DHCP/Auto-IP", and NetBIOS naming service is running on the computer). See Section 3.5 for a description of the hostname

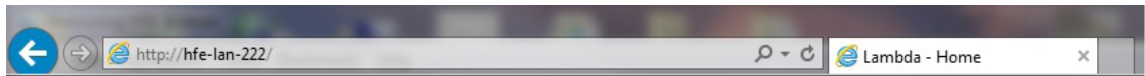

The module's Home page will appear. If it does not, see Troubleshooting section.

### 5.3 The HOME Page

The following page appears when the web page is first opened or when it is refreshed:



**HFE 1600W/2500W Series**  
**Front End DC Power Supplies**  
**LAN Option**

**TDK-Lambda**

Home	Welcome	
DC Power	TDK-LAMBDA Model:	HFE-LAN
LAN	Manufacturer:	TDK-LAMBDA
	Serial Number:	11111111111111111222
	Firmware Revision:	01.00

LAN	
IP Address	10.97.4.207
MAC Address	00:19:F9:00:00:5A
Hostname	HFE-LAN-222
Auto-MDIX	Yes
Auto-Negotiate	Auto select
Multicast DNS	Enabled
SNMP Service	Enabled

VISA	
Description:	TDK-LAMBDA HFE-LAN 222
VISA Name using IP Address:	TCPIP0::10.97.4.207::INSTR
VISA Name using Hostname:	TCPIP0::HFE-LAN-222.local::INSTR

Copyright © 2015-2016. All rights reserved.

Figure 4. HOME Page

**VISA Name Using IP Address:** For automation programming, VISA is a type of communication driver. For LAN instruments, the IP address may be used in the VISA resource descriptor.

**VISA Name Using Hostname:** For automation programming, an alternate VISA resource descriptor using the module’s hostname. See section 3.5

**Hostname:** A unique name for a device on a network. The default hostname is described in section 3.5, it is configured in section 5.5.2.

**Auto-MDIX:** The LAN module will automatically detect if a patch or cross-over LAN cable is used.

**Auto-Negotiate:** The LAN will automatically adjust its speed to the fastest available.

## 5.4 DC Power Page

When the “DC Power” tab is clicked, the following web page opens. This page and its submenus allows the user to make operations on the power supplies.

### 5.4.1 DC Power → Output Page



**HFE 1600W/2500W Series**  
**Front End DC Power Supplies**  
**LAN Option**

**TDK-Lambda**

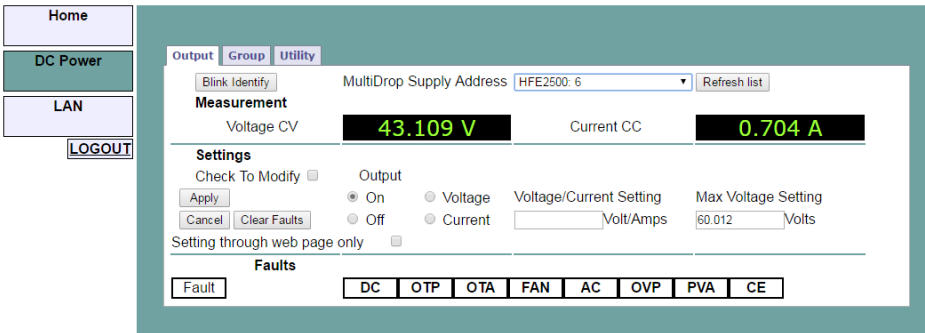
Copyright © 2015-2016. All rights reserved.

Figure 5. DC Power Page

### Measurement Section

**Multi Drop Supply Address:** Power Supply address will be from 0 to 12 depending on the slot in which the Power Supply is placed and the position of the DIP switch on the rear of the rack. Please refer to HFE1600-S1U and HFE2500-S1U user manuals for details on the slots and the DIP switch.

The address selected in this dropdown menu will correspond to the address of the Power Supplies installed in the rack.

Please refer to the table below for a link between the address in the drop down menu to address of the Power Supplies installed in the rack.

Drop Down Address	Actual HFE Address
HFE 0	0010000
HFE 1	0010001
HFE 2	0010010
HFE 3	0010011
HFE 4	0010100
HFE 5	0010101
HFE 6	001 0110
HFE 7	0010111
HFE 8	0011000
HFE 9	0011001
HFE 10	0011010
HFE 11	0011011
HFE 12	0011100

Table 6. Multi Drop Supply Address

**Refresh List:** When this button is clicked, the web page will make a scan to find connected HFE Power Supplies and put the discovered addresses into the list box.

Every time the “DC Power” web page is opened, it will automatically scan for all connected Power Supplies and display it in the drop down menu. If a Power Supply is added or removed after opening the “DC Power” web page, the “Refresh List” button will have to be clicked.

**Blink Identify:** When this button is clicked, the LAN module LAN LED (Green) blinks. This function allows the user to quickly identify which module is being communicated to in a rack of instruments. The blink identify is turned OFF by clicking this button again or with a LAN specific command.

**Measurements:** This section displays the selected Power Supply’s actual output voltage and current.

Please refer to HFE User Manual (/S option) for the range of Voltage, Current and Temperature Measurements for each model.

**Settings Section**

To change the Power Supply settings or the LAN settings, a user must first log in.

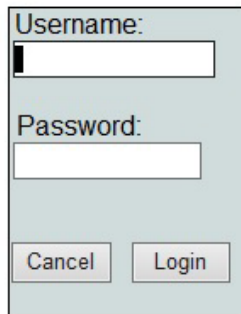

The image shows a login form with a light blue background. It contains two text input fields: the first is labeled "Username:" and the second is labeled "Password:". Below the input fields are two buttons: "Cancel" on the left and "Login" on the right.

**Login Rules:**

Only one web page user may be logged-in at a time to modify the power supply settings. Only one additional web page user may view the web pages of a power supply at the same time.

If an automation program using VISA or socket connection is running, you may view the web pages but you cannot login to change settings. Only one web page user may view the power supply settings.

If a web page user is logged in, a VISA or socket connection cannot be opened by an automation program.

***Note - It is prohibited to run combinations other than that specified in login rules.***



**Login:** Click the “Login” button at the bottom-left side of the web page. Enter “admin” in the user name box. By default, password is empty. Click “Login”.

A user may logout by clicking the “Logout” button, by closing the web browser or by leaving the web browser idle for “LAN Keep-alive” seconds.

The password may be set or changed on the LAN -> Users web page (see section 5.5.6). A front panel LAN reset or a LAN reset command will clear the password.

**Check to Modify:** Click this button to make the changes. If this button is not clicked, no changes can be made.

After the changes are made, de-select the button.

**Output:** Click the On/Off button to make the Power Supply On or Off.

**Voltage / Current Setting:** In the case of HFE2500 supply, two programming buttons will be seen – Voltage and Current. For first time entry in the Output section, the Voltage/Current setting window will be blank. Click on Voltage or Current button to view the settings.

Enter the value in the window. Click “Apply”. Deselect “Check to Modify” button and the programmed Voltage or Current setting will be seen in the Voltage/Current setting window.

Please refer to HFE User Manual (/S option) for the range of Voltage and Current programming for each model (\*1).

In the case of HFE1600 supply, there is voltage programming only, so only the voltage setting will be seen in the Voltage/Current setting window.

**Maximum Voltage Setting:** Maximum voltage setting can be entered in the Max. Voltage setting window. This is a protection window and will not allow programming voltage to go beyond the value set in the window. (This will not create an OVP fault.)

Supply	Maximum Voltage (*1)
12V	15V
24V	30V
32V	40V
48V	60V

**Table 7. Maximum Voltage Setting Values**

Ex - If the above value is set to 49V, the output voltage cannot be set above 49V.

If Current programming is selected, this value has to be at maximum.

**Note - Any value programmed beyond the range will result in “Data out of Range” message on the display.**

**If the current programming value is sent without the “%” sign, “Percentage Symbol missing” will be seen on the display.**

**Note – If the “Check to Modify” button is not de-selected, the programmed values will not be seen after a new value is set.**

**Settings through Web Page only:** When this button is clicked, power supply settings and LAN settings can be carried out via the web page only. Settings cannot be carried out via other protocols. Only monitoring is available via other protocols.

The default setting is “disabled”.

**Faults Section**

This section displays the selected power supply's Fault register. If any fault occurs, the "Fault" LED will lit. It will be required to scan all the supplies in the chain to check which of the supply has generated the fault. If the supply is found, the respective fault LED will be lit.

Indicator	Faults
DC	DC Fail
OTP	Over Temperature Protection
OTA	Over Temperature Alarm
FAN	Fan Fail
AC	AC Fail
OVP	Over Voltage Protection
PVA	Programmed Voltage more than Allowed
CE	Command Error

*Table 8. Faults Indicator*

**Clear Faults:** If any of the fault occurs, the fault will get registered in the fault register. It will not be cleared even if the fault is not present. With this button, the fault register can be cleared. If the fault is present after the "Clear Faults" button is clicked, the fault will be registered again in the fault register.

**5.4.2 DC Power → Group Page**



**HFE 1600W/2500W Series**  
**Front End DC Power Supplies**  
**LAN Option**

**TDK-Lambda**

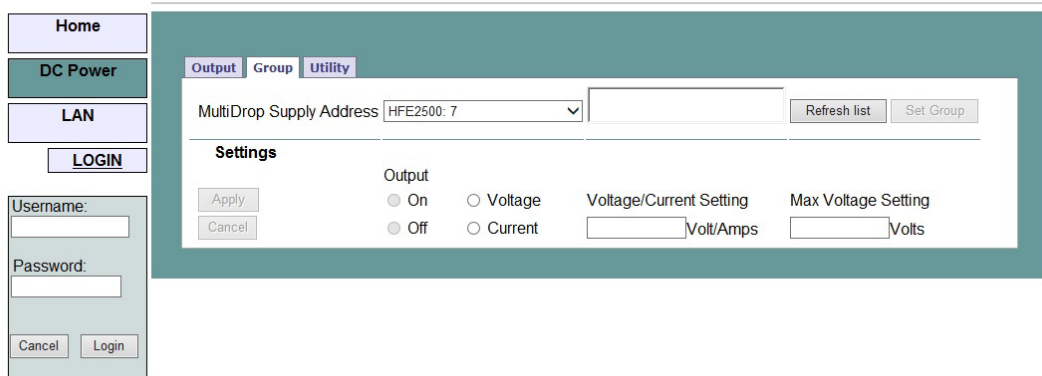

Copyright © 2015-2016. All rights reserved.

**Fig 6. Group Page**

This section can be used for programming a group of supplies. As soon as the supplies are selected from the drop down menu, they will appear in the box next to it. Click on "Set Group". Select the operation – ON/OFF, Voltage or Current Setting or Max Voltage Setting. Click "Apply".

**Note – This section must be used for supplies of the same type.**

**No other copy of web page should be open.**

**The user setting must be set to "One Client only". Refer to Section 5.5.2**

### 5.4.3 DC Power → Utility Page

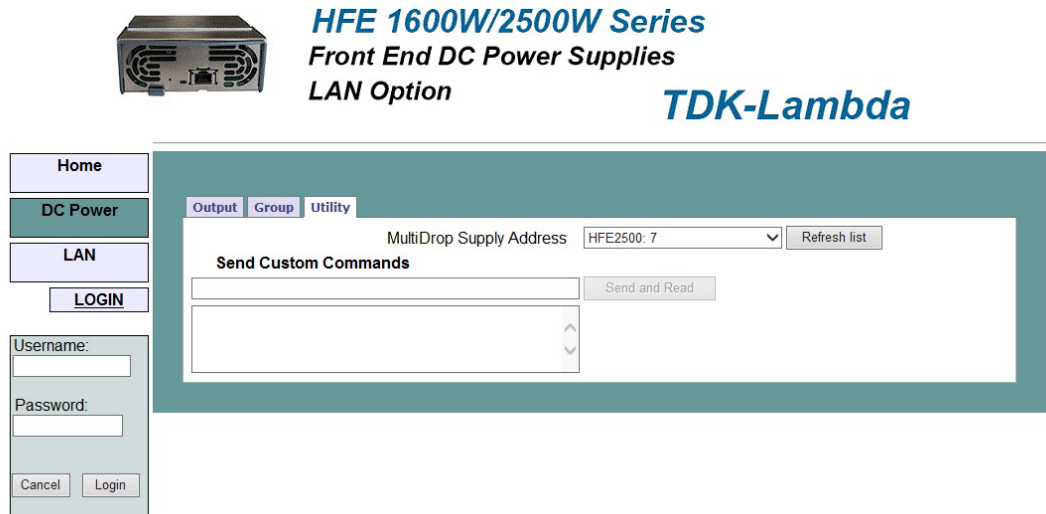

Copyright © 2015-2016. All rights reserved.

**Fig 7. Utility Page**

This page is used to send any command and see the response. It is a learning tool for operations. It allows commands which are not present on the web pages. Type any message into the top text box. Click the "Send and Read" button. For commands, there is no response. For queries, the response is shown in the bottom text box.

## 5.5 LAN Page

This page and its subpages allow you to view and configure the module’s LAN settings.

### 5.5.1 LAN → Configure Page

When the “LAN” tab is selected, the “Configure” panel opens:



**HFE 1600W/2500W Series**  
Front End DC Power Supplies  
LAN Option



Home

DC Power

LAN

LOGIN

Configure

Advanced

SNMP Settings

Users

Present LAN Configuration

IP Address Source:	DHCP/Auto IP
IP Address:	10.97.4.206
Subnet Mask:	255.255.254.0
Default Gateway:	10.97.4.1
DNS Server:	10.97.2.244
Hostname:	HFE-LAN-222
Description:	TDK-LAMBDA HFE-LAN 222
Controller Access:	One Client Only
Multicast DNS:	Enabled

Copyright © 2015-2016. All rights reserved.

**Fig 8. LAN Configuration**

The following settings are shown on the “LAN → Configure” web page:

**IP Address Source:** Displays the way the IP address was selected. Options are DHCP/Auto-IP and Static IP.

**IP Address:** Displays the IP address assigned to the module through either DHCP, Auto-IP or Static IP sources.

**Subnet Mask:** Displays the subnet mask assigned to the module through either DHCP, Auto-IP or Static IP.

**Default Gateway:** Address of the network router to allow the module to communicate outside of the local subnet.

**DNS Server:** Address of the server running the Domain Naming Service. This is used for hostname addressing.

**Hostname:** The module hostname may be used instead of the IP address to create a communication link. The default hostname is derived from the model and serial number (see section 3.5) or it may be changed in the LAN → Configure → Modify web page (section 5.5.2).

**Description:** By default, this is “TDK-LAMBDA HFE-LAN last 3 digits of serial number”, but it may be changed in the LAN → Configure → Modify web page (section 5.5.2).

**Controller Access:** The “One Client Only” setting is the default setting for the highest networking security. This setting allows only one TCP socket or VISA connection to be open at a time. It disables the connectionless UDP sockets. See section 5.5.2.

**Multicast DNS:** Resolves Host Name to IP Address in networks that do not include a local server. By default, this is enabled.

**Modify:** Click this button to open the window shown below

**5.5.2 LAN → Configure → Modify Page**

If user is logged in, clicking the “Modify” button on the LAN → Configure window, the following window appears. On this window, you may enter new values for the LAN settings. The available fields depend on the selection of “DHCP Assigned / AUTO IP” or “Static IP”

Changes to these setting will not take place until the “Apply” button is clicked

*Note: After changing the LAN settings, the web browser will automatically close. Re-open it using the new address*



**HFE 1600W/2500W Series**  
Front End DC Power Supplies  
LAN Option

**TDK-Lambda**

Copyright © 2015-2016. All rights reserved.

**Fig 9. DHCP Settings**

**TCP/IP Mode:** This selects how the module gets its network settings. Select either:

**DHCP Assigned / AUTO IP:** If this mode is selected, the network server uses DHCP to assign the IP address, subnet mask, default gateway and DNS server. Since the server assigns these, they are disabled (gray) on the web page. If the server cannot make the assignment, the module shall revert to the Auto IP method described in section 3.4

In this mode, the user may only change the hostname and description.

**Static IP:** If this mode is selected, the IP address, subnet mask and default gateway must be entered in the window fields. The settings must be compatible with the requirements of the network server. These settings do not change even if the module is moved to different LAN connections.

In this mode, DNS server fields are disabled (gray)

In this mode, the user can also change the host name and description.



**HFE 1600W/2500W Series**  
**Front End DC Power Supplies**  
**LAN Option**

**TDK-Lambda**

The screenshot shows the 'LAN Modify' configuration window. On the left is a navigation menu with 'Home', 'DC Power', 'LAN' (highlighted), and 'LOGOUT'. The main area contains the following settings:

- TCP / IP Mode:**  Static IP,  DHCP Enabled / Auto IP
- IP Address:** 10, 97, 4, 206
- Subnet Mask:** 255, 255, 254, 0
- Default Gateway:** 10, 97, 4, 1
- DNS Server:** 10, 97, 2, 244
- Hostname:** HFE-LAN-222
- Description:** TDK-LAMBDA HFE-LAN 222
- Controller Access:**  One client only,  Multiple clients
- Multicast DNS:**  mDNS Enabled,  mDNS Disabled

Buttons for 'Apply' and 'Close' are at the bottom.

Copyright © 2015-2016. All rights reserved.

**Fig 10. Static IP Settings**

**Controller Access:** Select the security feature for one client only or multiple clients.

The multiple clients setting is needed to allow more than one controller connection at a time and to enable UDP socket connections.

**Multicast DNS:** Enable or Disable the mDNS.

**Apply:** Click this button to save the new settings.

**Close:** Click this button to close the window.

**5.5.3 LAN → Advanced Page**

Click the "LAN → Advanced" button to view and set four advanced LAN settings:



**HFE 1600W/2500W Series**  
**Front End DC Power Supplies**  
**LAN Option**

**TDK-Lambda**

The screenshot shows the 'LAN Advanced' configuration page. The navigation menu is the same as in Fig 10. The main area has tabs for 'Configure', 'Advanced' (selected), 'SNMP Settings', and 'Users'. Below the tabs is a table titled 'Present LAN Configuration':

Present LAN Configuration	
LAN Timeout:	1800
Ping Server:	ENABLED
Auto-Negotiate:	Auto Select
Vxi Discovery:	ENABLED
Auto-MDIX:	YES

A 'Modify' button is located at the bottom of the table.

Copyright © 2015-2016. All rights reserved.

**Fig 11. LAN Advanced Page**

**LAN Keep-Alive:** If you are logged in, this is how many seconds the web pages and all other protocols may be unused (idle) before the module automatically logs the user out.

The default is 1800 seconds = 30 minutes.

Range is 30-60000 sec.

**Ping Server:** 'Ping' is a network utility that allows the computer to verify communication with the LAN module. This service may be disabled in the "Modify" panel.

**Auto-Negotiate:** This shows what network speed the LAN card is allowed to operate at. Auto Select, 10Mbps and 100Mbps can be selected.

**VXI Discovery:** This is a protocol which allows the network server to detect what instruments are connected to the LAN. It may be disabled in the "Modify" panel for security reasons.

*Note: Disabling VXI-11 discovery disables VXI-11 communication.*

**Auto-MDIX:** This service is always enabled in the module. The module LAN connection will always detect a patch or cross-over cable.

**Modify:** After logging in, click this button to open the window shown below

#### 5.5.4 LAN → Advanced → Modify Page

In the window below, you may enter new values for the LAN settings. Changes to these settings will take place when the "Apply" button is clicked.



**HFE 1600W/2500W Series**  
**Front End DC Power Supplies**  
**LAN Option**

**TDK-Lambda**

LAN Modify	
LAN Timeout	1800 Seconds
Ping Server	<input checked="" type="radio"/> Enable <input type="radio"/> Disable
Auto-Negotiate	Auto select
VXI-11 Discovery	<input checked="" type="radio"/> Enable <input type="radio"/> Disable
<input type="button" value="Apply"/> <input type="button" value="Close"/>	

Copyright © 2015-2016. All rights reserved.

**Fig 12. LAN Advanced Page**

### 5.5.5 SNMP Settings

Using SNMP, users can easily manage system performance and remotely find and solve system problems. The HFE LAN serves as an SNMP Agent. A SNMP Host system is used to communicate with this SNMP agent.

A key part of the SNMP protocol is the Management Information Base (MIB) that describes all Agent variables that can be accessed. The MIB will be needed by any SNMP Host that wishes to communicate with the HFE LAN and can be retrieved from: <https://uk.tdk-lambda.com/technical-centre/software-tools.aspx>

HFE LAN utilizes four operations to respond to Host: Get, GetNext, Set and Trap

- Get – Allows the Host to retrieve a value from the HFE LAN.
- GetNext – Allows the Host to retrieve the next value from a list of variables in HFE LAN.
- Set – Allows the Host to set a value within the HFE LAN
- Trap – Used by the HFE LAN to inform the Host of an event. The HFE LAN must be configured with appropriate address of the Host.



**HFE 1600W/2500W Series**  
**Front End DC Power Supplies**  
**LAN Option**

**TDK-Lambda**

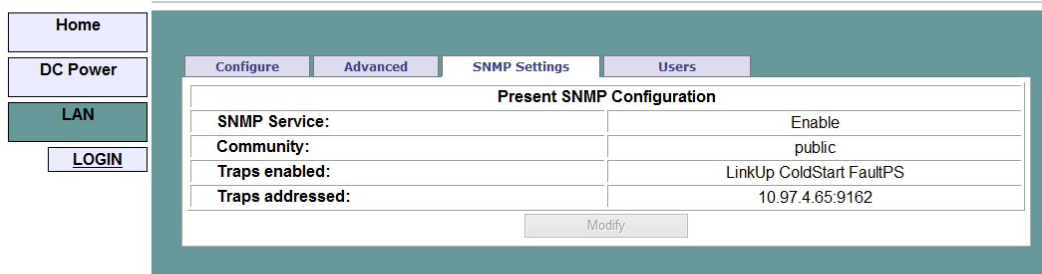

**Fig 13. SNMP**

Copyright © 2015-2016. All rights reserved.

**SNMP Service:** Service can be enabled or disabled.

**Community:** Always public.

**Traps Enabled:** There are 3 types of traps

1. Link Up – Whenever a new link is made.
2. Cold Start – Whenever LAN settings are changed.
3. Faults PS - At any power supply fault.

Any of them can be enabled or disabled.

**Traps Address:** Address and port number of the Host where traps are received.

**Note:** AC Fail trap may not be detected at high load condition due to power supply's short hold up time.



*Note: If a power supply generates a trap, any further traps from the same or other power supplies will not be seen until the fault register of the supply which generates the trap is cleared.*



**HFE 1600W/2500W Series**  
 Front End DC Power Supplies  
 LAN Option

**TDK-Lambda**

**Fig 14. SNMP Settings**

**5.5.6 LAN → Users Page**

This page allows the user to create password protection for the web pages. There is no password protection for automation programming with VISA or sockets.

By default, the “old password” is blank. The new password must be six or more characters long. Characters allowed: a to z, A to Z and 0 to 9.

**Reset the password:** once a password is applied, it may be changed by using this screen, but it can only be removed by performing the “LAN Reset” function from the module front panel or by using LAN reset command.



**HFE 1600W/2500W Series**  
 Front End DC Power Supplies  
 LAN Option

**TDK-Lambda**

Copyright © 2015-2016. All rights reserved.

**Fig 15. User Settings**

## **6. PROGRAMMING USING VISA DRIVERS**

### **6.1 VISA Description**

In the test and measurement industry, Virtual Instrument Software Architecture (VISA) is a popular framework that includes hardware drivers, configuration utilities and connection managers. A variety of communication busses are supported. VISA drivers are available from several instrument vendors.

Any programming language that supports Windows COM or DLL libraries can call the VISA functions. VISA drivers may be downloaded for Windows, Linux and MAC OS. Some licensing issues may apply.

### **6.2 VXI-11 Compatibility**

VXI-11 is a protocol that allows communications between a computer port and an instrument. VISA is built upon the VXI-11 specification. The HFE LAN module is compatible with the VXI-11 protocols.

- o VXI-11 Device\_link Open link to instrument
- o VXI-11 Device\_write Write text to the instrument
- o VXI-11 Device\_read Read text from an instrument
- o VXI-11 Destroy\_link Close link to instrument

### **6.3 Opening the VISA Connection**

Test and automation programs may easily be written if they use the VISA libraries. The supported VISA functions include Open, Read, Write and Close.

A VISA resource descriptor is used to describe a particular module. For HFE LAN module, the descriptors are found on the module's Home web page. The VISA resource may use the module's IP address or hostname.

Example VISA resource descriptors for the HFE LAN module are:

Format: TCPIP[board]::IP address/Host Name[::LAN device name][::INSTR]

[board] is the LAN card number, zero is optional

[::LAN device name] is by default "inst0"

[::INSTR] is optional

Examples: TCPIP::10.225.26.60::inst0::INSTR

TCPIP1::HFE-LAN-222::INSTR

### **6.4 Communicating Using VISA**

The VISA Write function will send commands to the module, the VISA read will read the response returned from a query.

## 7. PROGRAMMING USING SOCKETS

### 7.1 Socket Description

The VISA drivers for the HFE LAN module with LAN are popular in the Test and Measurement world. However, some customers cannot use VISA because of installation or licensing issues or because the controller (i.e.: industrial PLC) does not have support for VISA.

If you cannot use VISA drivers, then the HFE LAN offers socket connections. This is low-level LAN protocol that is universally available in all operating systems and programming environments.

### 7.2 Communicating Using Sockets

Communicating through sockets involves opening a socket connection, sending text commands and reading the responses. The functions a programming language use to manage the socket is called the TCP or UDP stack.

There are two types of socket protocols which may be used, TCP and UDP. Each has its own port number.

### 7.3 Controller Access: Single and Multiple Clients

The web page has a security setting to limit or enable the types of connections and numbers of control computers (called "clients") that may be connected in parallel.

The rules for the One Client/Multiple Clients are:

	One Client Only	Multiple Clients
Web Page <b>Not logged-in</b>	Max 2 copies of web pages may be open at any time. You may view but cannot change the module operation.	
Web Page <b>Logged-in as "admin"</b>	You cannot log in if a VISA or socket port is already open. If you are logged in, any other connections are blocked. Only one additional copy of web page may be opened.	
<b>VISA Connection</b>	Only one VISA port may be open at one time. Only one copy of web page may be opened.	
<b>TCP Socket</b> <b>UDP Socket</b>	TCP socket may be opened. UDP sockets are blocked. Only one copy of web page may be opened.	Single connection of UDP or maximum 2 connections of TCP are allowed at the same time.

Table 8: One client/Multiple clients rules.

*Note - It is prohibited to run combinations other than that specified.*

### 7.4 Input Buffer Requirements

With a controller using TCP or UDP sockets, the module can receive commands much faster than it can process the commands. To make sure the HFE LAN is not overloaded, it is required that the controller sometimes sends a query and then waits for the response. The response is the acknowledgement from HFE LAN that it has finished processing all commands.



It is recommended that your controller routinely sends "SYST:ERR?". This query takes little time, and it verifies that all commands have been accepted correctly.

### 7.5 Message Terminators

**When using a program that sends separate commands out through a TCP socket, the socket drivers may combine all the messages into one long packet. Therefore, it is necessary to add a terminator character to the end of each command.**

All SCPI commands must have a terminator character.	
	Terminator Character (and ASCII hex)
	Commands from the Controller One or more terminators required: Line-feed,      Carriage-return 0x0A                    0x0D
	Responses from the HFE LAN All responses have Line-Feed at the end. 0x0A

Table 9: Terminator

### 7.6 Using TCP Sockets

This is the most popular socket type. It features a managed connection, message acknowledgements, transmission error detection and correction.

Open **TCP socket port 8003** to send commands.

Responses to queries are sent back automatically with a line-feed terminator appended.

If the web page LAN controller access is set to "Multiple Clients", then up to two controllers may open TCP sockets to one module at the same time.

### 7.7 Using UDP Sockets

This is a simpler socket type with reduced network traffic. It is a 'connectionless' protocol because messages are sent and there is no acknowledgement.

Open **UDP socket port 8005** to send commands.

Responses to queries are sent back automatically with a line-feed terminator appended.

Before opening a UDP socket, it is required to open the web page and set the controller access to "Multiple Clients" (see section 5.5.2).

## 8. COMMAND SET

### 8.1 Selecting an Individual Power Supply

This command can be used to select an individual power supply from a group of supplies. If there is only 1 power supply in the entire chain, the command is not required.

Syntax:      INST:NSEL <xx>  
              INST:NSEL?  
Parameter:  xx – address of the supply to be selected  
Example:     INST:NSEL 6  
Query:       INST:NSEL? Will return the address of the supply selected.

### 8.2 Selecting a Group of Power Supplies

This command can be used to select a group of supplies.

Syntax:      INST:COUP <x1,x2,.....>  
              INST:COUP all  
Parameter:  x1, x2 – Supplies to be selected  
              all – All Supplies in the chain are selected  
Example:     INST:COUP 2,4  
              INST:COUP all  
Query:       None

*Note – No copy of web page should be opened while operating with group commands.  
To exit the group command, use INST:NSEL xx*

### 8.3 Output On/Off

This command turns an individual power supply or a group of power supplies On or Off.

Syntax:      OUTP <0/OFF or 1/ON >  
              OUTP?  
Parameter:  0 or OFF will set the power supply output to OFF  
              1 or ON will set the power supply output to ON  
Example:     OUTP 1 (or OUTP ON)  
Query:       OUTP? Will return ON in the example, otherwise OFF

*Note – The Query returns the status of the command, not the status of the power supply.*

### 8.4 Clear Faults

This command is used to clear the status register of the power supply after any fault occurs. If the fault is still present after the “Clear Faults” command is sent, the fault will be registered in the fault register again.

Example:    OUTP:PROT:CLE

### **8.5 Programming the Output Voltage**

This command sets the Voltage Limit.

Syntax:     VOLT<nn.nn>  
          VOLT?

Parameter:  nn.nn. Please refer to HFE User Manual (/S option) for the range of Voltage programming for each model.

Example:    VOLT 46.5

Query:      VOLT? Will return 46.5 in the example.

Errors:     SYSTEM:ERROR? May return:  
            "Data out of range"

### **8.6 Programming the Current Limit (HFE2500/S only)**

This command sets the Current Limit.

Syntax:     CURR<nn.nn>%  
          CURR?

Parameter:  nn.nn. Please refer to HFE User Manual (/S option) for the range of Current programming for each model.

Example:    CURR 90%

Query:      CURR? Will return 90% in the example.

Errors:     SYSTEM:ERROR? May return:  
            "Data out of range"  
            "Percentage Symbol Missing"

### **8.7 Programming the Maximum allowed Programmable Output Voltage**

This command is used to set the maximum Allowed Voltage. This acts as a Voltage limiter and does not allow the Voltage to be programmed to higher than this value. (refer to table 7)

Syntax:     VOLT:PROT:LEV <nn.nn>  
          VOLT:PROT:LEV?

Parameter:  nn.nn - 12V Supply – 15V, 24V Supply – 30V  
            32V Supply – 40V, 48V Supply – 60V  
            These are maximum values.

Example:    VOLT:PROT:LEV 46

Query:      VOLT:PROT:LEV? Will return 46 in the example.

(Note: This does not create an OVP fault.)

Errors:       SYSTEM:ERROR? May return:  
                  "Data out of range"

*Note: If Current programming is done, the above setting has to be at maximum.*

### 8.8 Output Voltage Monitoring

This query returns the measured voltage.

Syntax:       MEAS:VOLT?

Example:      MEAS:VOLT? May return 46.002

### 8.9 Output Current Monitoring

This query returns the measured current.

Syntax:       MEAS:CURR?

Example:      MEAS:CURR? May return 50.147

### 8.10 Temperature Monitoring

This query returns the internal temperature.

Syntax:       MEAS:TEMP?

Example:      MEAS:TEMP? May return 71.065

*Note - Please refer to page HFE User Manual (/S option) for the range of Voltage, Current and Temperature Measurements for each model.*

### 8.11 Read Faults

This command is used to read the status of the Power Supply. The status information is stored in the "STATUS REGISTER". This command can read 8 different types of faults and warnings.

Syntax:       STAT:QUES:COND?

Example:      STAT:QUES:COND? May return 326, Output Fail:HFE7.

<b>Fault</b>	<b>Reply</b>
DC Fail	326, Output Fail:"HFE Address"
Over Temperature Protection	322, Over Temperature Shutdown:"HFE Address"
Over Temperature Alarm	328, Over Temperature Alarm:"HFE Address"
FAN Fail	329, Fan Fail:"HFE Address"
AC Fail	321, AC Fail:"HFE Address"
Over Voltage Protection	324, Over Voltage Protection:"HFE Address"
Voltage more than allowed	-330, Data more than allowed:"HFE Address"
Command Error	-100, Command Error:"HFE Address"

Table 10: Faults

**8.12 Enabling / Disabling the Monitoring Filter**

Syntax: DISP:FILT ON / OFF  
 Parameter: ON will turn the filter ON.  
               OFF will turn the filter OFF.  
 Example: DISP:FILT ON  
 Query: DISP:FILT? Will return ON in this example

**8.13 Programming and Monitoring Coefficients**

These Coefficients are used internally by the LAN module. These are not required by the end user. They are part of the HFE PMBUS command set.

Function	Command
Voltage Monitoring Coefficient	MEAS:VOLT:COEF?
Current Monitoring Coefficient	MEAS:CURR:COEF?
Temperature Monitoring Coefficient	MEAS:TEMP:COEF?
Voltage Programming Coefficient	VOLT:COEF?
Current Programming Coefficient	CURR:COEF?

Table 11: Coefficients

**8.14 Inventory Details of the Power Supply**

**8.14.1 PMBUS Revision**

Syntax: SYST:VERS?  
 Example: SYST:VERS? Will always return 1.1

**8.14.2 Manufacturer Name**

Syntax: SYST:ID?  
 Example: SYST:ID? Will always return TDK-LAMBDA

**8.14.3 Model Name**

Syntax: SYST:MDL?  
 Example: SYST:MDL? May return HFE1600-48/S

**8.14.4 Nominal Output**

Syntax: SYST:XVM?  
 Example: SYST:XVM? May return 48V

**8.14.5 Software Revision**

Syntax: SYST:REV?  
 Example: SYST:REV? May return 1.5

**8.14.6 Manufacturing Location**

Syntax: SYST:LOC?  
 Example: SYST:LOC? May return CHINA



### 8.14.7 Manufacturing Date

Syntax: SYST:DATE?

Example: SYST:DATE? May return 12/12/2016

### 8.14.8 Serial Number

Syntax: SYST:SER?

Example: SYST:SER? May return DOD705BED0171W

## 8.15 Inventory Details of the LAN Module

### 8.15.1 Software Revision

Syntax: SYST:COMM:LAN:VERS?

Example: SYST:COMM:LAN:VERS? May return 1.28.18

### 8.15.2 Serial Number

Syntax: SYST:COMM:LAN:SER?

Example: SYST:COMM:LAN:SER? May return 12345

## 8.16 LAN Specific Commands

### 8.16.1 Read the Hostname

Syntax: SYST:COMM:LAN:HOST?

Example: SYST:COMM:LAN:HOST? May return HFE-LAN-222

The hostname string is up to 15 characters long

### 8.16.2 Read the IP Address

Syntax: SYST:COMM:LAN:IP?

Example: SYST:COMM:LAN:IP? May return 10.97.4.233

The IP address string is up to 15 characters long

### 8.16.3 Read the MAC Address

Syntax: SYST:COMM:LAN:MAC?

Example: SYST:COMM:LAN:MAC? May return 00:19:f9:00:24:3b

The MAC address string, 17 characters long

### 8.16.4 Reset LAN Settings

**WARNING: Sending this command will disable the LAN connection to the module**

This command will reset the LAN settings to the factory default state. The effect of this includes changing the IP address and hostname, so LAN communication could be lost. Therefore, use this command as a diagnostic tool only.

Syntax: SYST:COMM:LAN:RES

Example: SYST:COMM:LAN:RES

*Note: Reset does not affect SNMP enable/disable setting*

### 8.16.5 Blinking the Blink Identity LED

Syntax: SYST:COMM:LAN:IDLED 1 or ON, 0 or OFF

Example: SYST:COMM:LAN:IDLED 1

## 8.17 Scan for active power supplies

This command scans for active power supplies, returns the location in the rack.

Syntax: SYST:SCAN?

Example SYST:SCAN? may return PS:0,2,4

## 9. TROUBLESHOOTING

### **LAN Status LED Stays Red**

If LAN status LED stays red, then the module is not connecting to the network.

- A. Verify the LAN cable is connected to an active network. Look at the front panel link LED (part of the RJ-45 connector, see section 1.3) and verify it is green. If the LED is not lit, then the LAN cable is not connected properly.
- B. Wait longer and try to read the IP address again. In the Auto-IP mode the module will wait a full 60-90 seconds to assign an IP address after powerup.

### **Cannot Communicate to the Module**

If the LAN Status LED is green and the module has a valid IP address, and you still cannot open a web page, VISA or socket connection then try "pinging" the module. The ping utility verifies the computer can send a message and get a response from the module over the network.

Open a command line window by:

- A. Click the "Start" button, Select "Run..."
- B. A "Run" window opens. Type: cmd <Enter>. See the command window open
- C. Type "ping <IP address>"

Verify the ping packets had successful responses

If the "ping" does not get responses from the module, then there is a mismatch between the module and the computer LAN settings. Also, the ping function may be disabled in the module. In this case, do a module "LAN Reset" and try to connect again

### **Cannot Open Web using Laptop or Dual-LAN Card Computer**

If you have a computer with two network cards, the computer may not know which card to use when trying to open the HFE web page. Verify the two cards do not have over-lapping IP address ranges, otherwise it may be necessary to disable or disconnect the network card that is not being used.

If you have a laptop computer with an Ethernet jack and a wireless network, it may be necessary to disable the wireless LAN port.

### **Web Page "Refresh List" Does Not Find Slave Supplies**

When you are using a LAN chain of supplies, the web page Refresh List button should detect all the connected slave supplies. If it does not:

- A. Verify all slave supplies are set for unique addresses.

### **LAN Status LED is blinking**

While setting an IP Address, Duplicate IP has been detected. Stop the blinking by a LAN specific command or by the Blink Identity command on the Web page and try assigning a new IP Address.



