

## Power Line Common Mode Chokes/Filters

May 23, 2024  
Simple Model

Automotive Grade for Power Line / ACM90V series

### Circuit Diagram

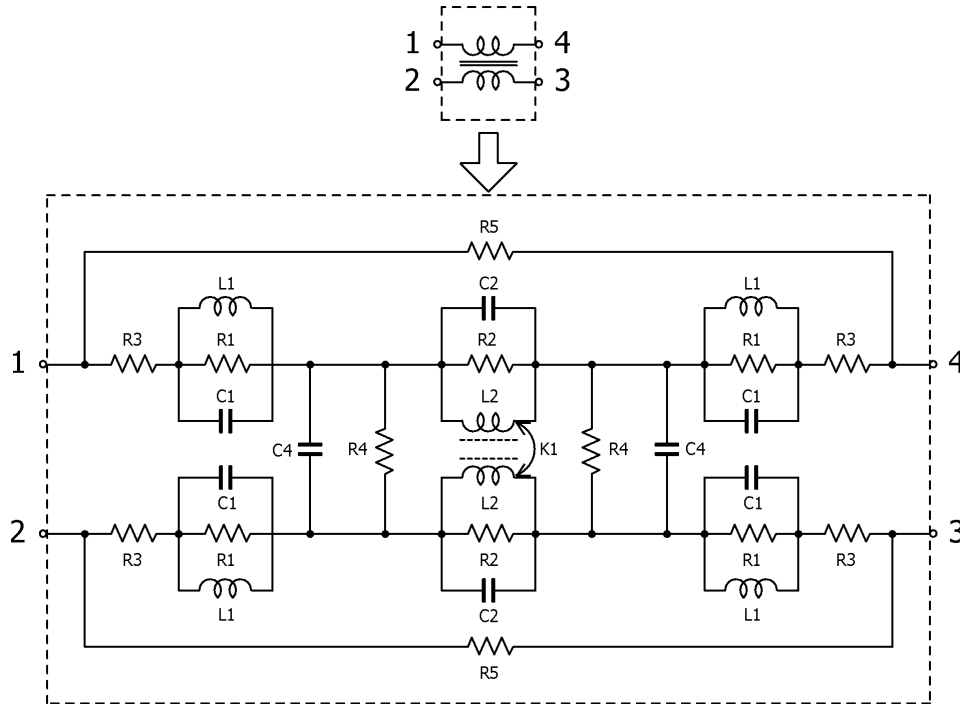

### Circuit Parameters

Part No.	R1[ohm]	L1[nH]	C1[pF]	R2[ohm]	L2[nH]	C2[pF]	R3[ohm]	R4[Gohm]	C4[pF]	R5[Gohm]	K1
ACM90V-701-2PL-TL00	100	1.0	0.01	1,630	5,830	0.096	0.003	1	2.45	1	0.93796
ACM90V-152-2PL-TL00	100	1.0	0.01	3,370	10,900	0.094	0.006	1	3.48	1	0.93221